



The Community College of Baltimore County

FY17

Organizational Chart

Organizational Chart FY 2017

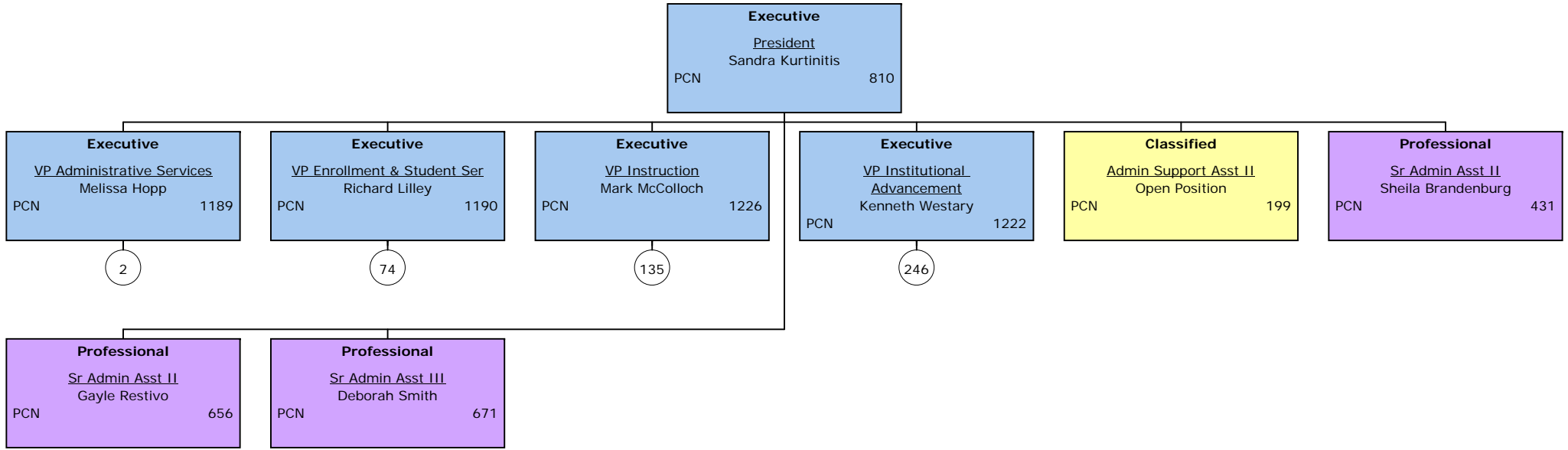

Organizational Chart FY 2017

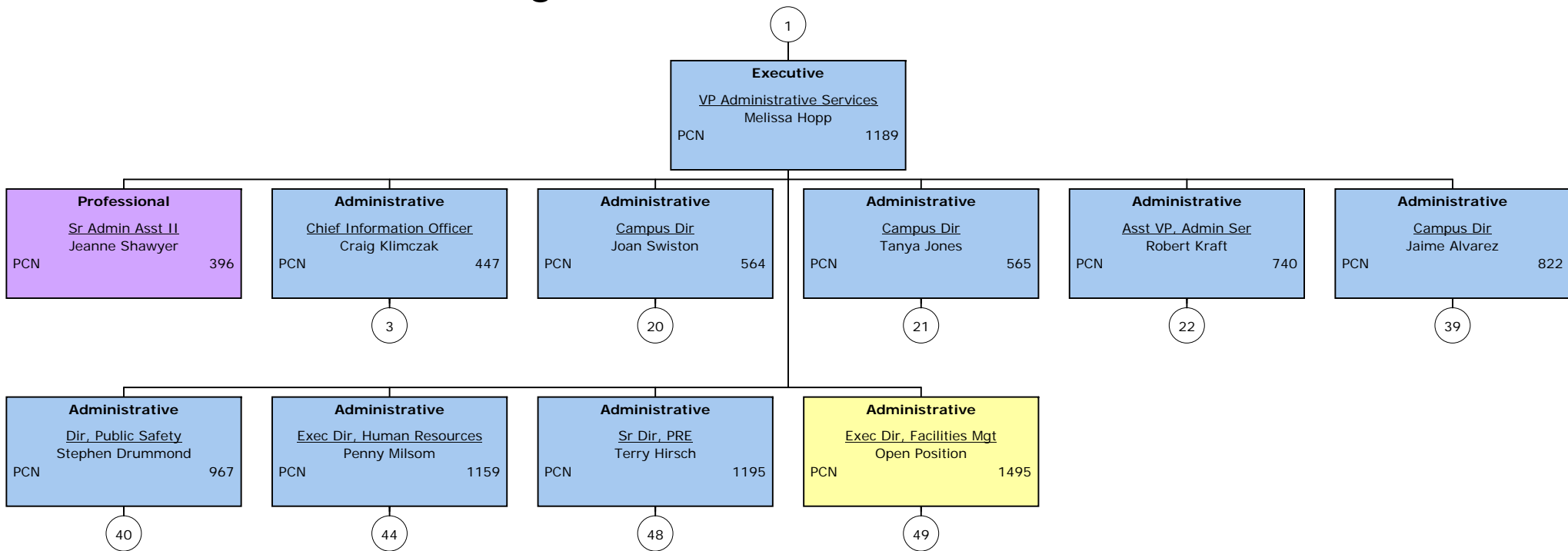

Organizational Chart FY 2017

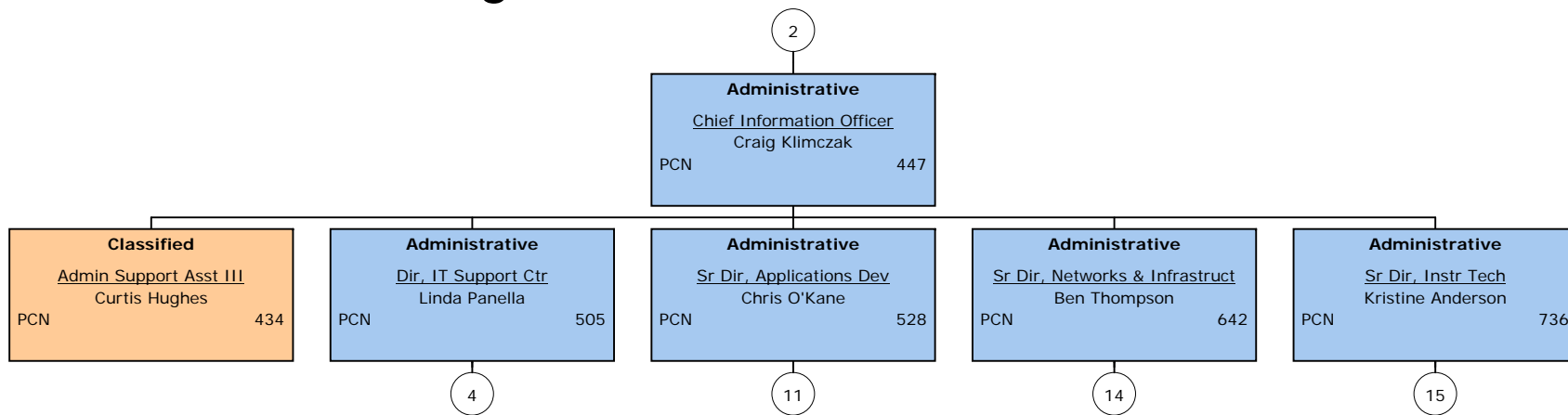

Organizational Chart FY 2017

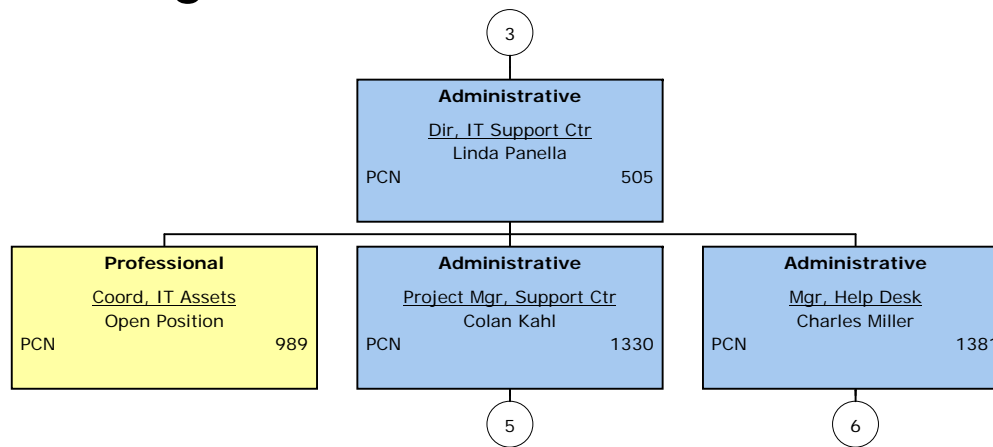

Organizational Chart FY 2017

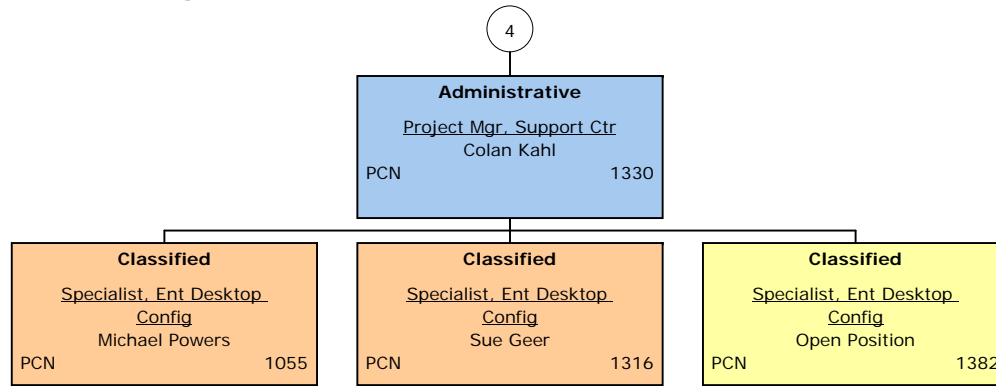

Organizational Chart FY 2017

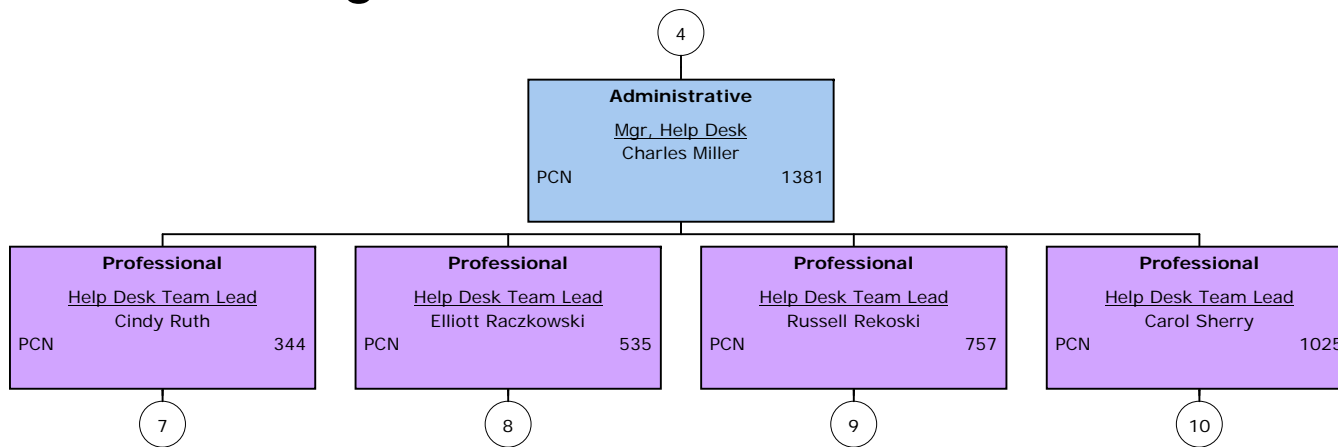

Organizational Chart FY 2017

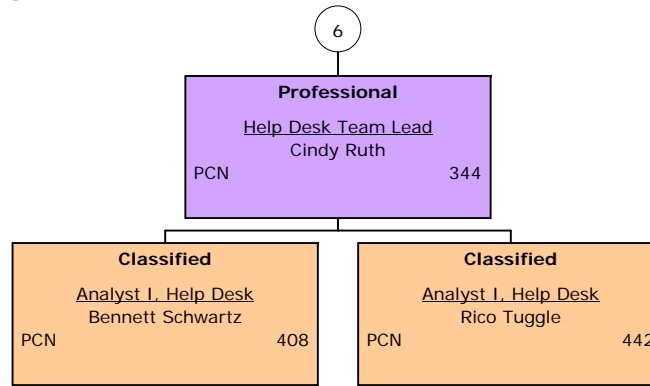

Organizational Chart FY 2017

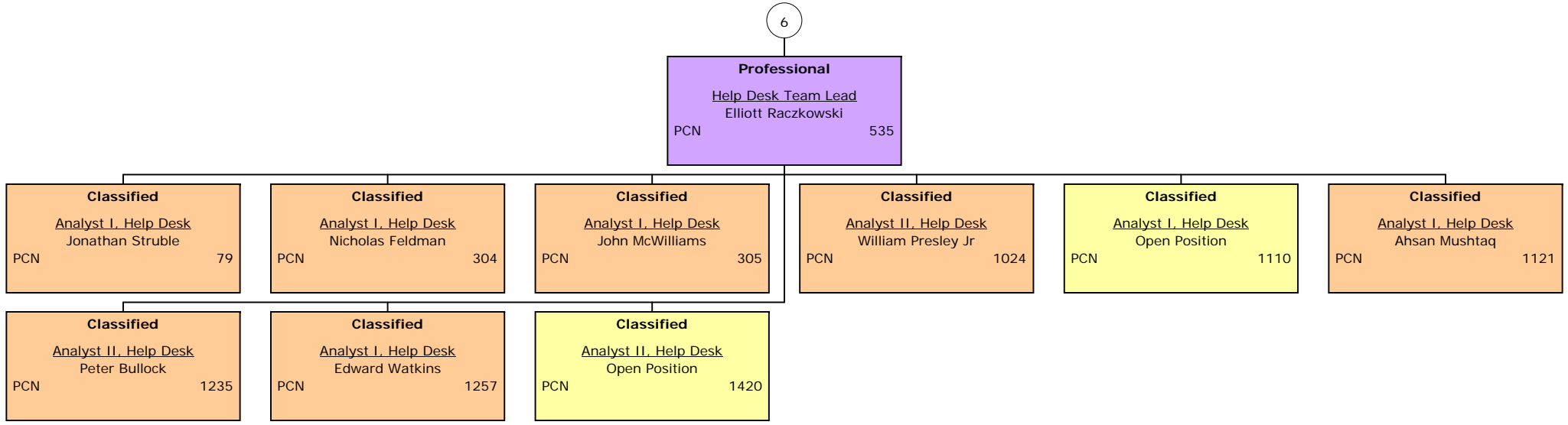

Organizational Chart FY 2017

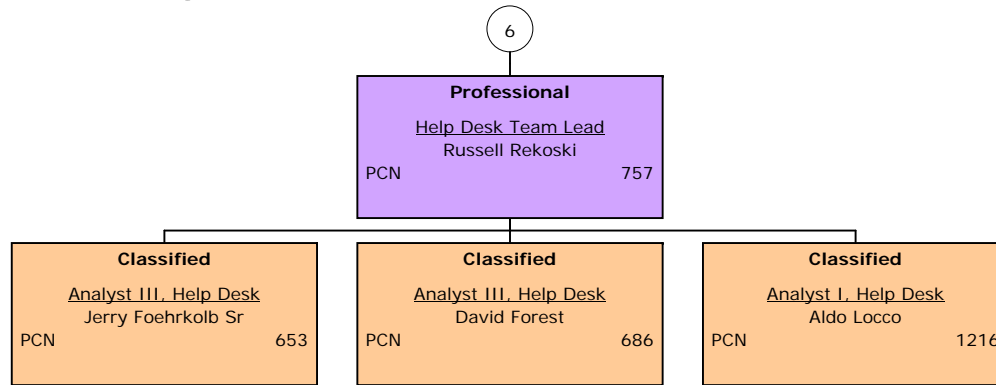

Organizational Chart FY 2017

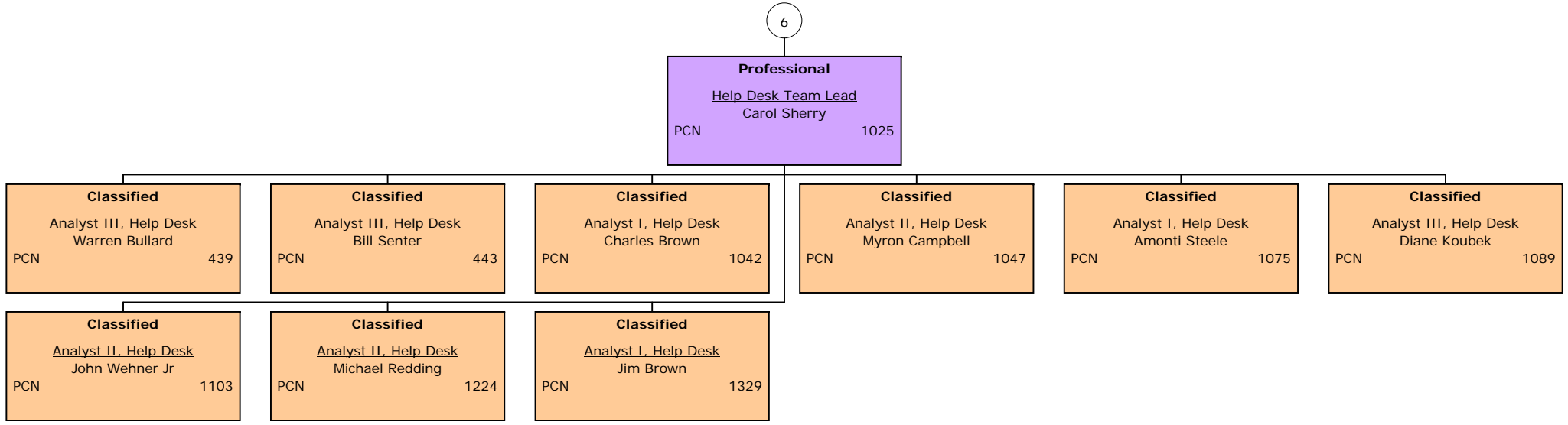

Organizational Chart FY 2017

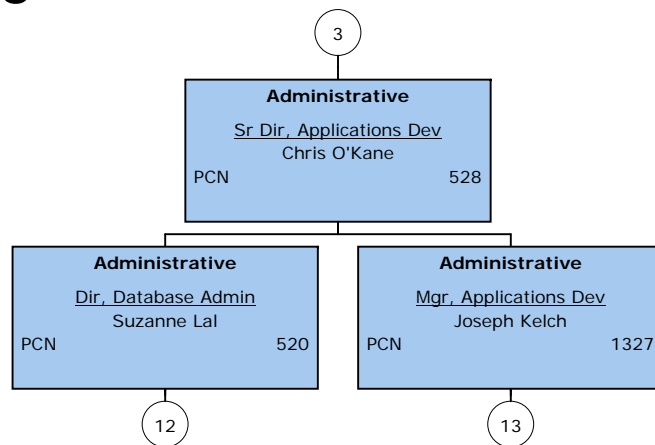

Organizational Chart FY 2017

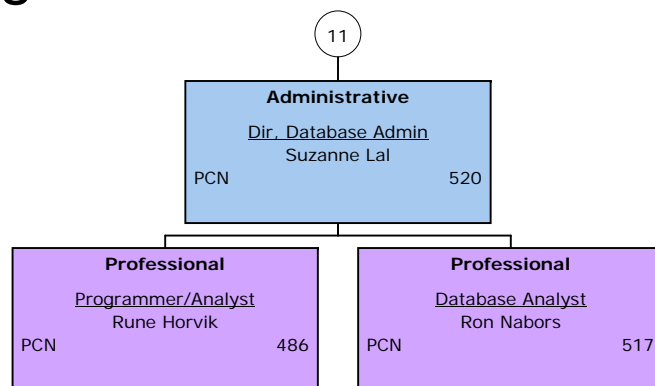

Organizational Chart FY 2017

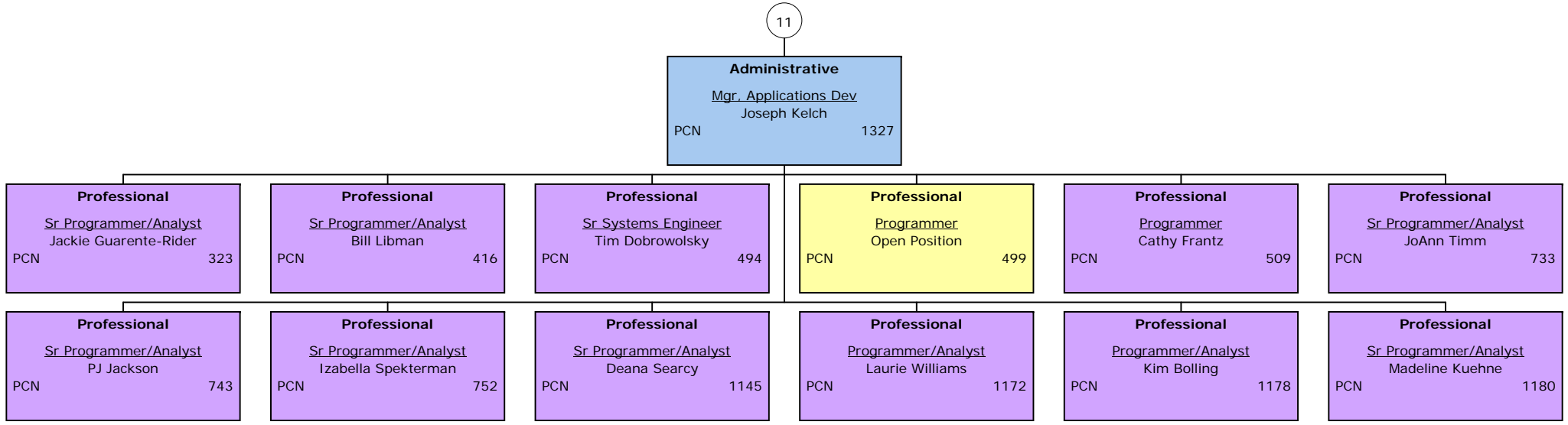

Organizational Chart FY 2017

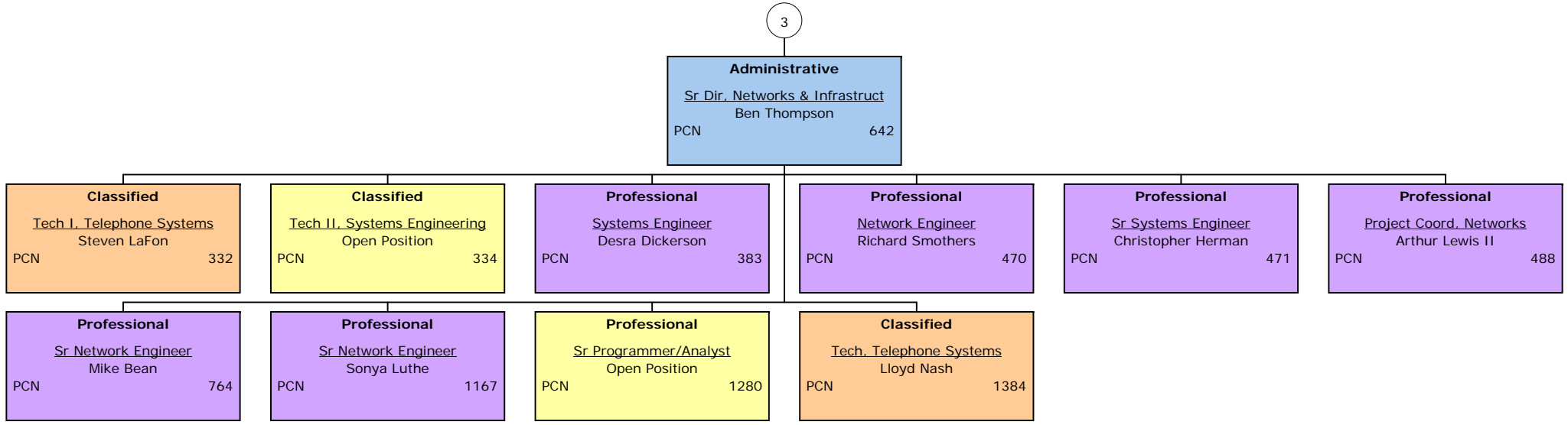

Organizational Chart FY 2017

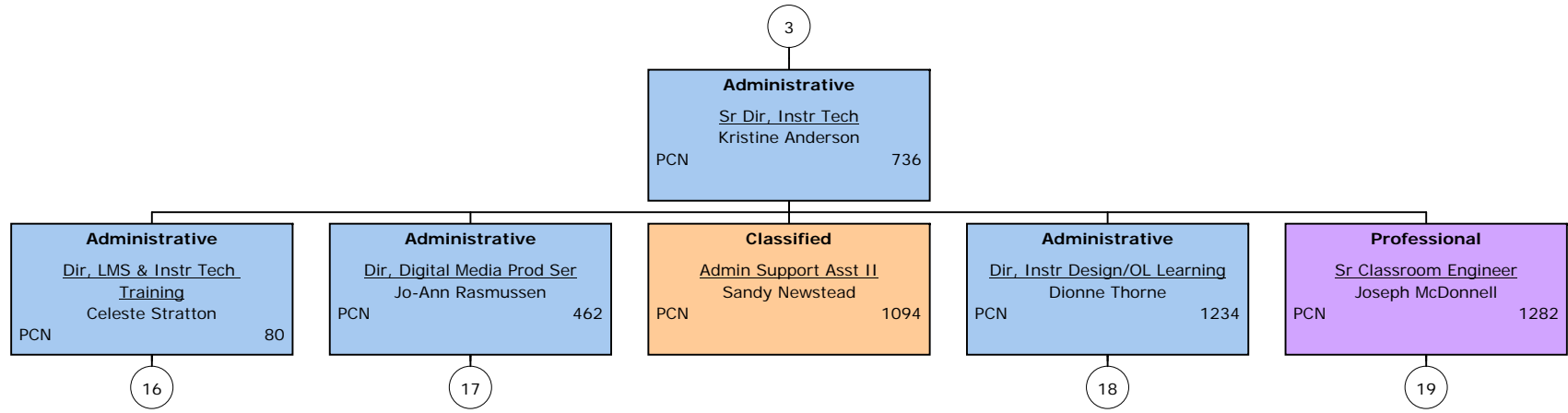

Organizational Chart FY 2017

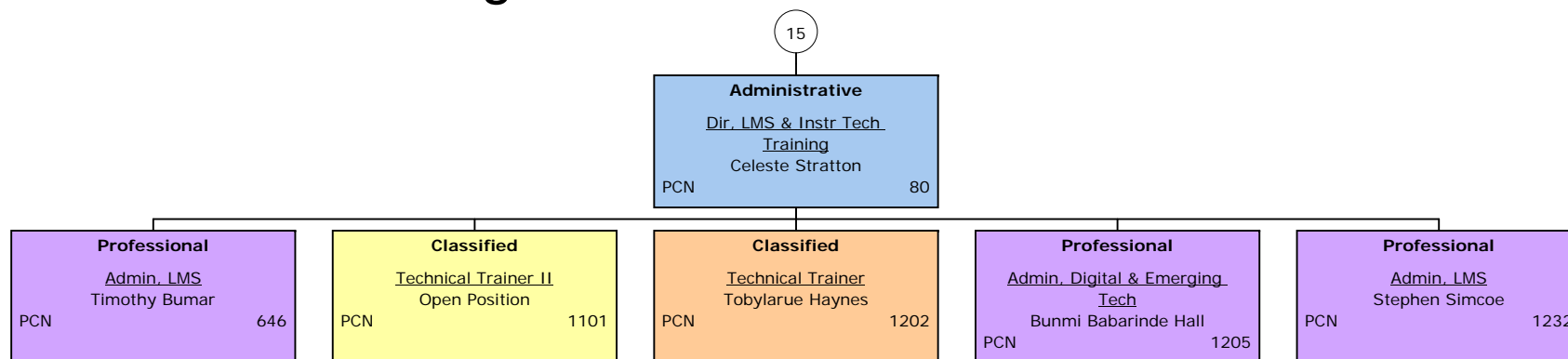

Organizational Chart FY 2017

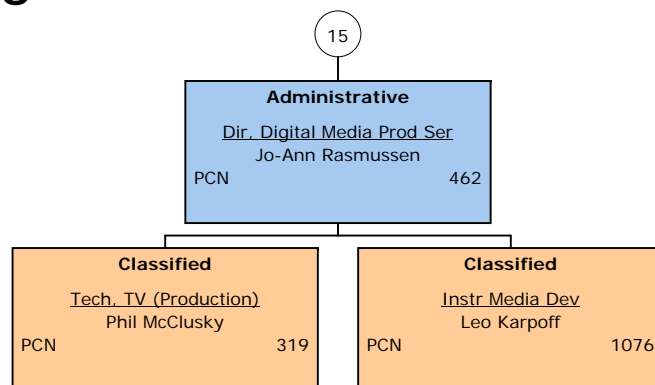

Organizational Chart FY 2017

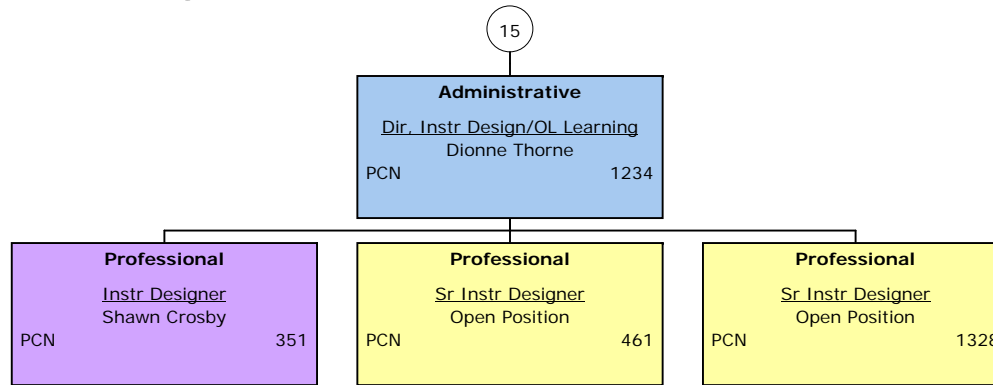

Organizational Chart FY 2017

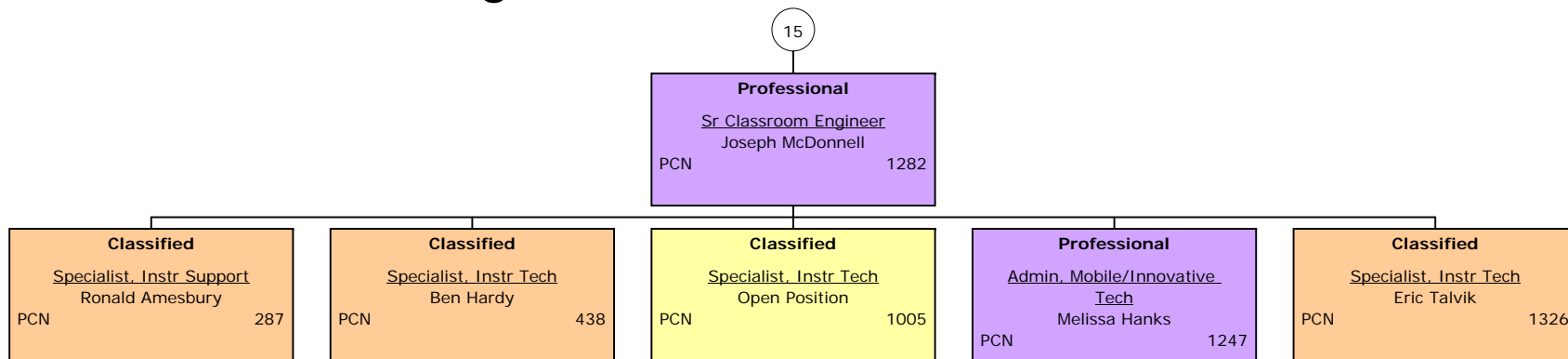

Organizational Chart FY 2017

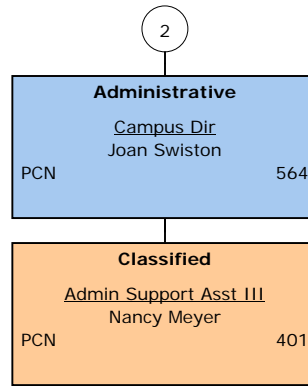

Organizational Chart FY 2017

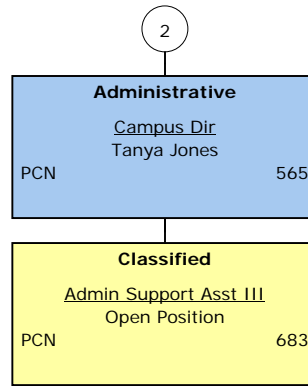

Organizational Chart FY 2017

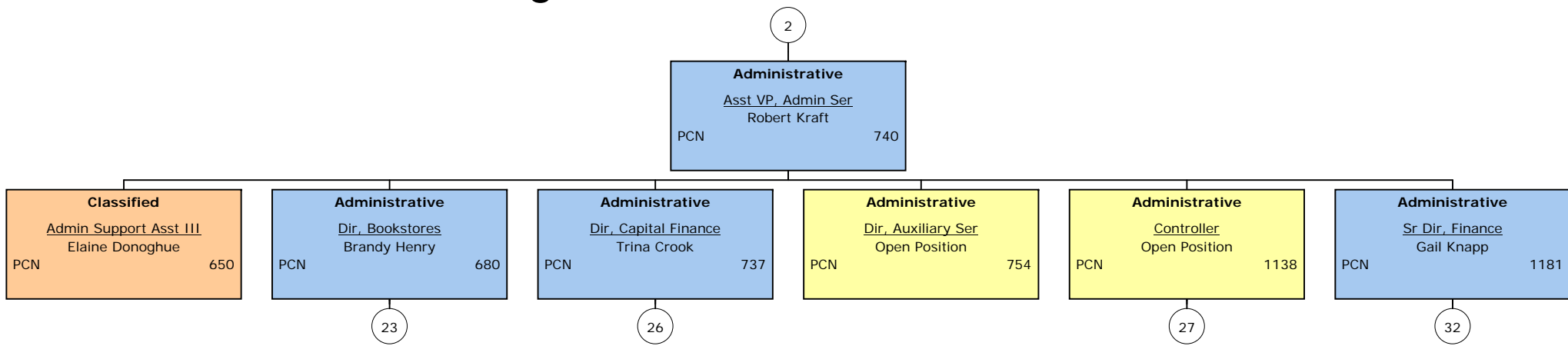

Organizational Chart FY 2017

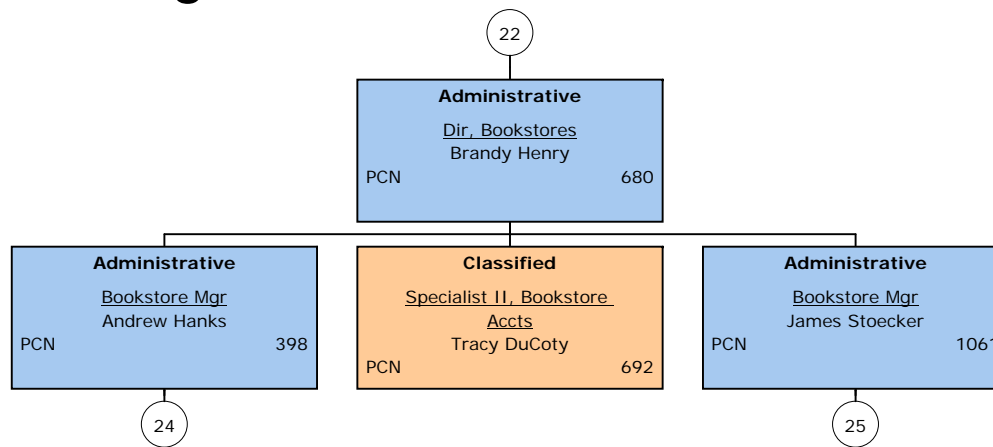

Organizational Chart FY 2017

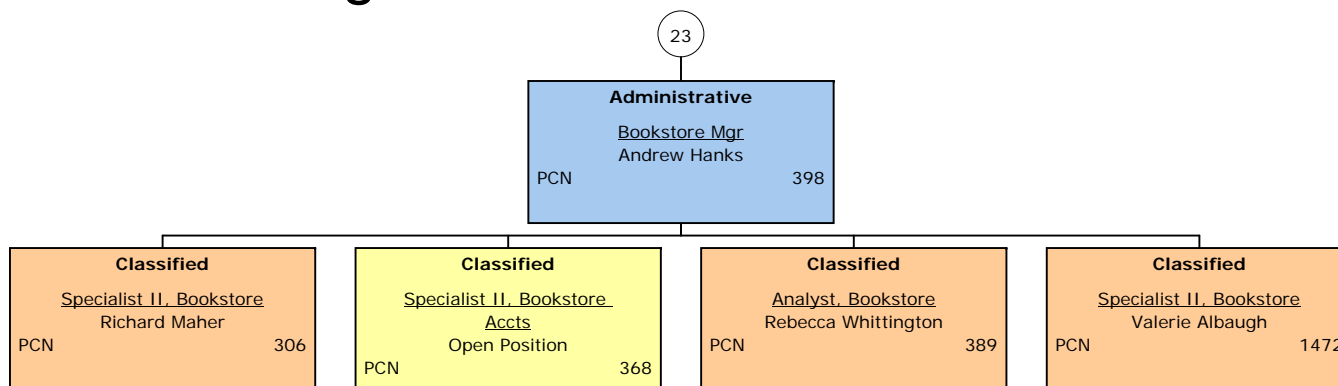

Organizational Chart FY 2017

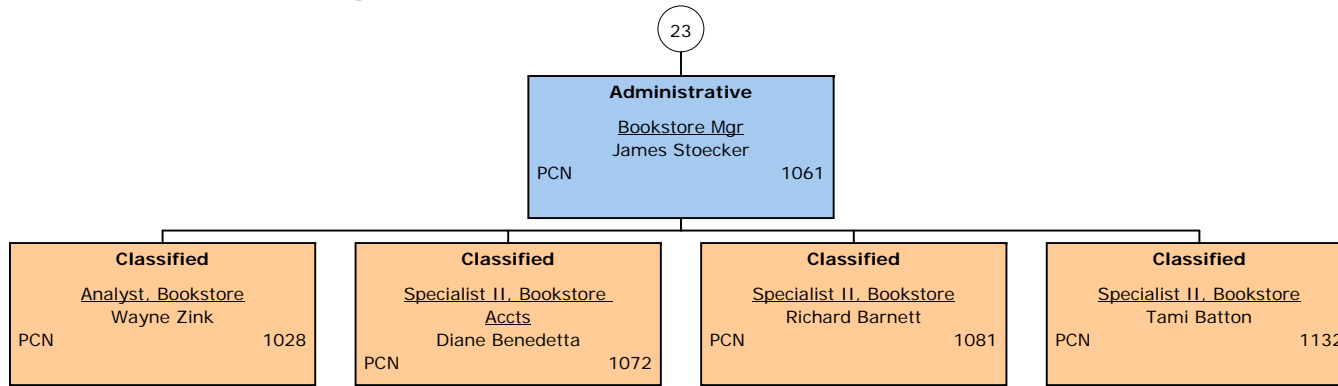

Organizational Chart FY 2017

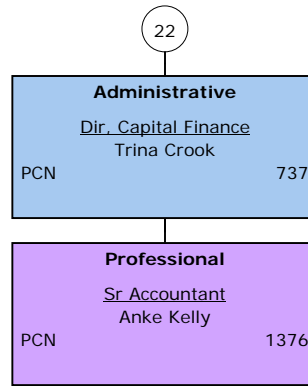

Organizational Chart FY 2017

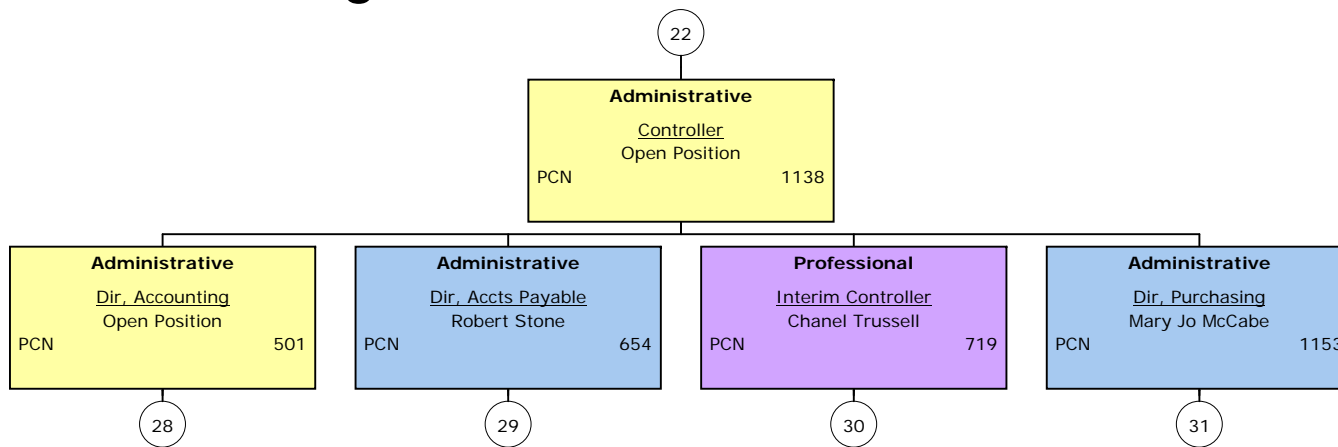

Organizational Chart FY 2017

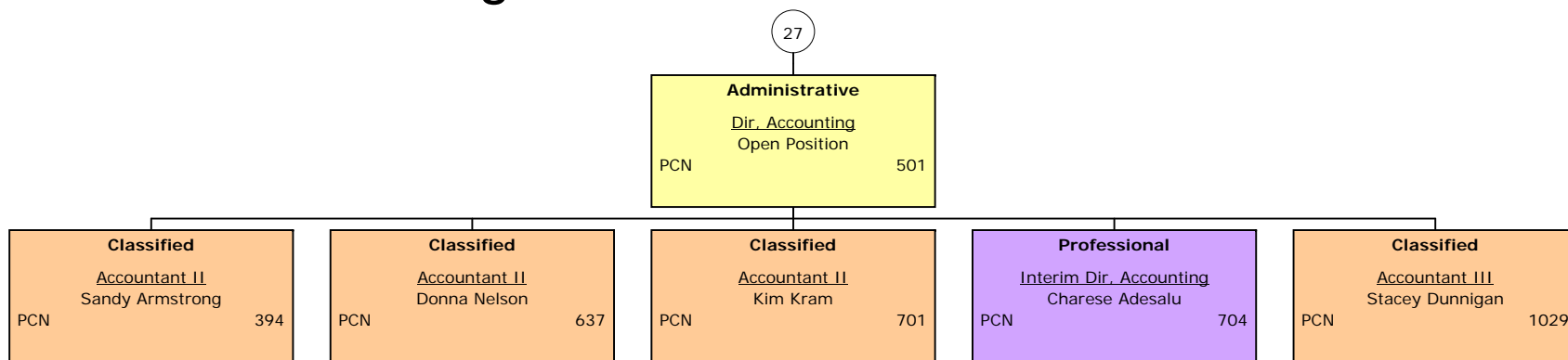

Organizational Chart FY 2017

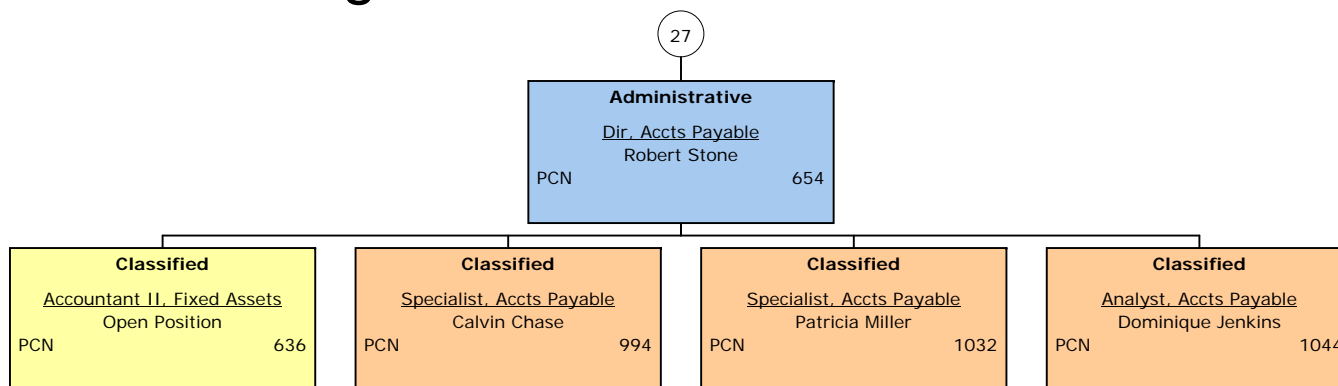

Organizational Chart FY 2017

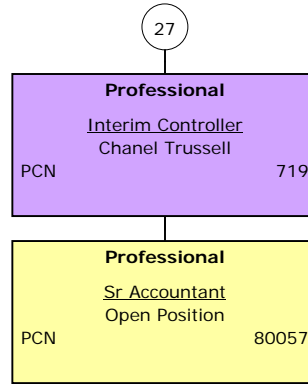

Organizational Chart FY 2017

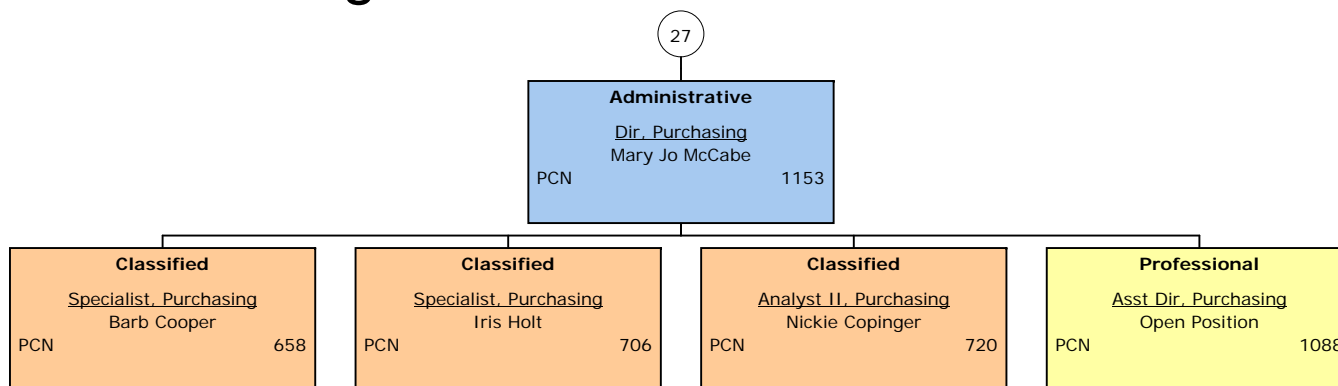

Organizational Chart FY 2017

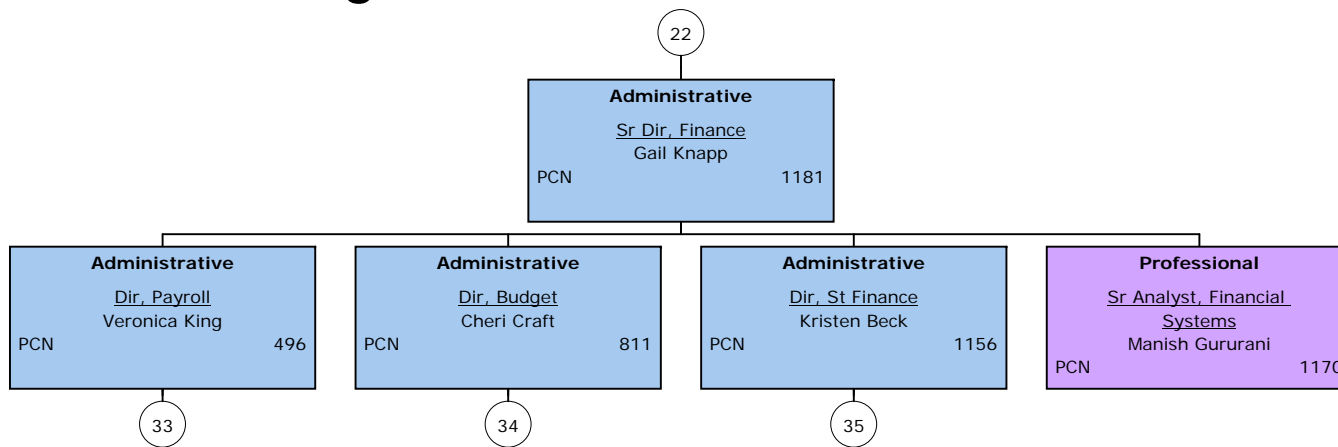

Organizational Chart FY 2017

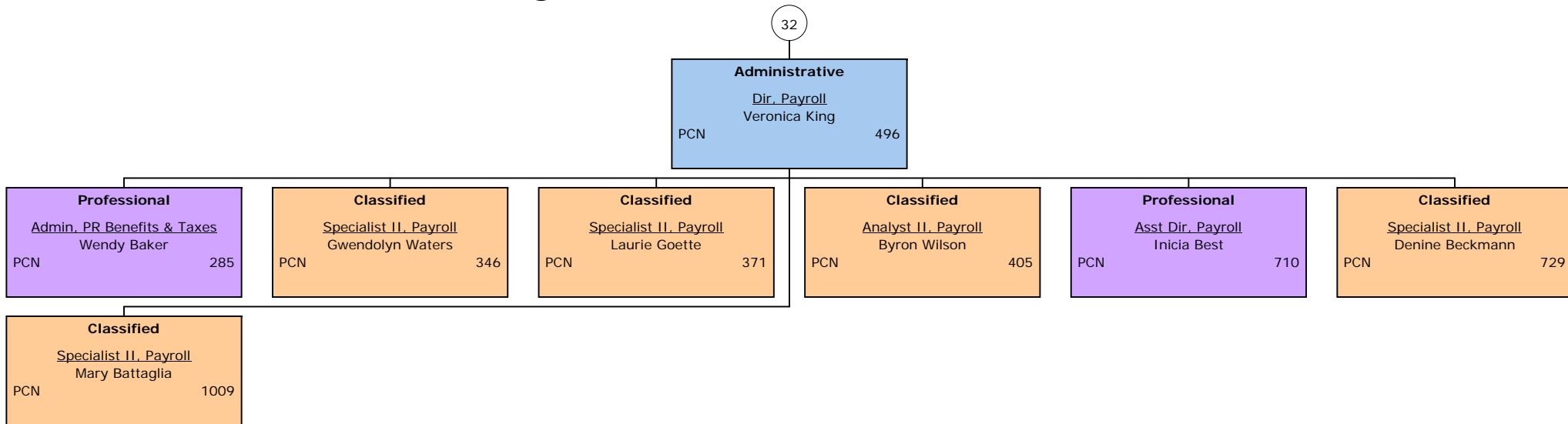

Organizational Chart FY 2017

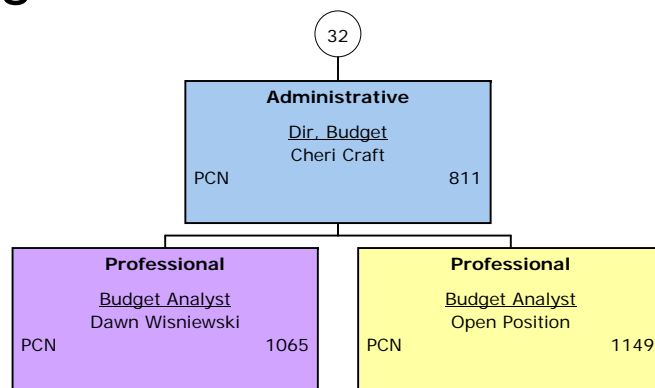

Organizational Chart FY 2017

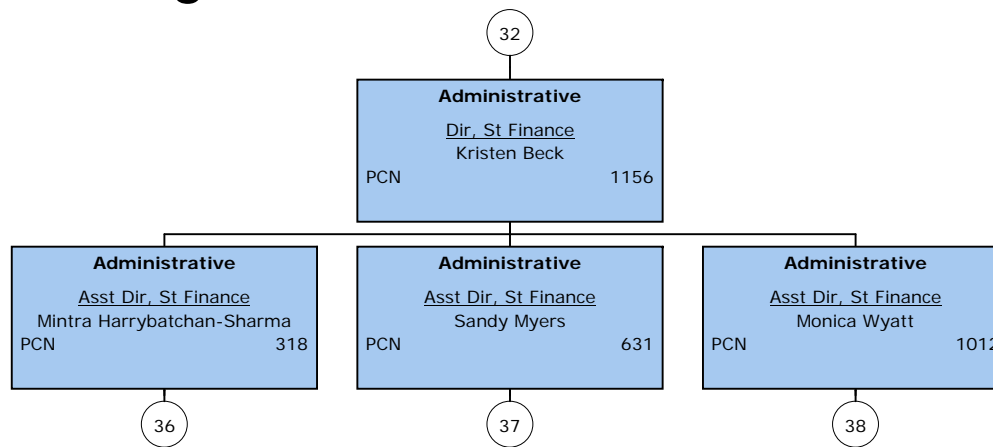

Organizational Chart FY 2017

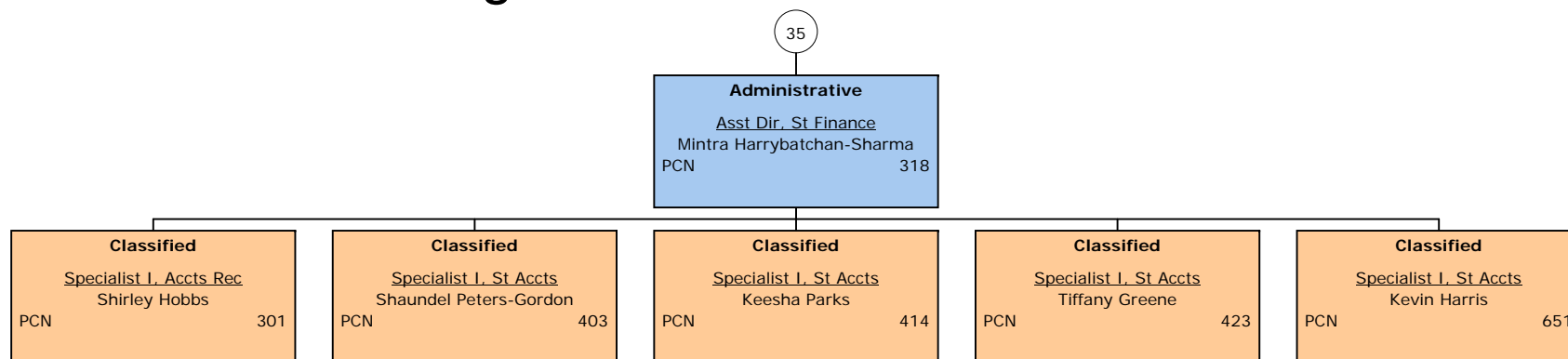

Organizational Chart FY 2017

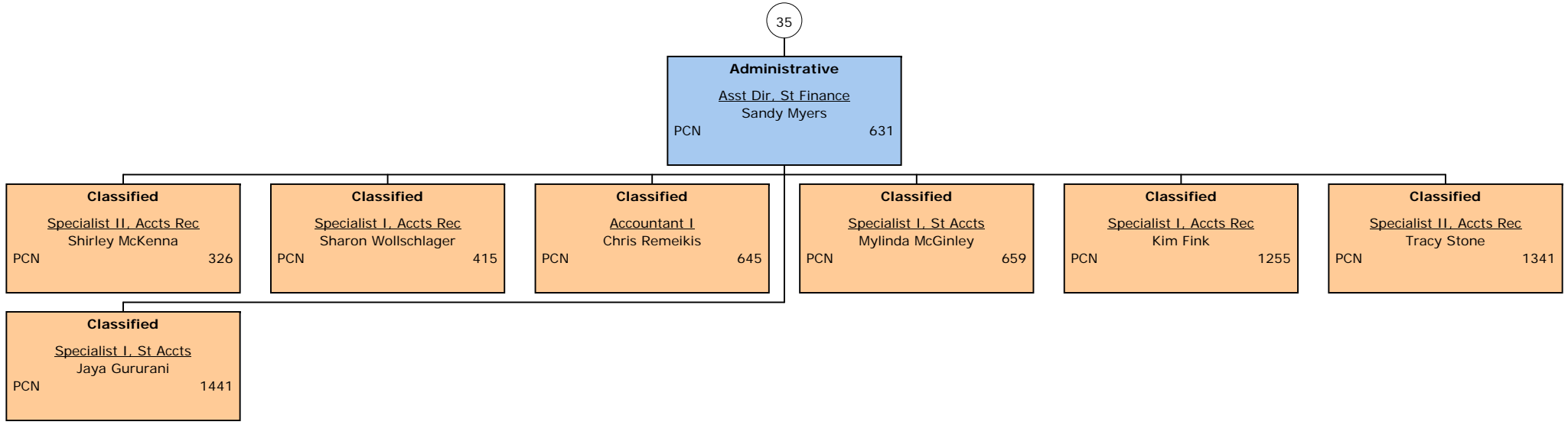

Organizational Chart FY 2017

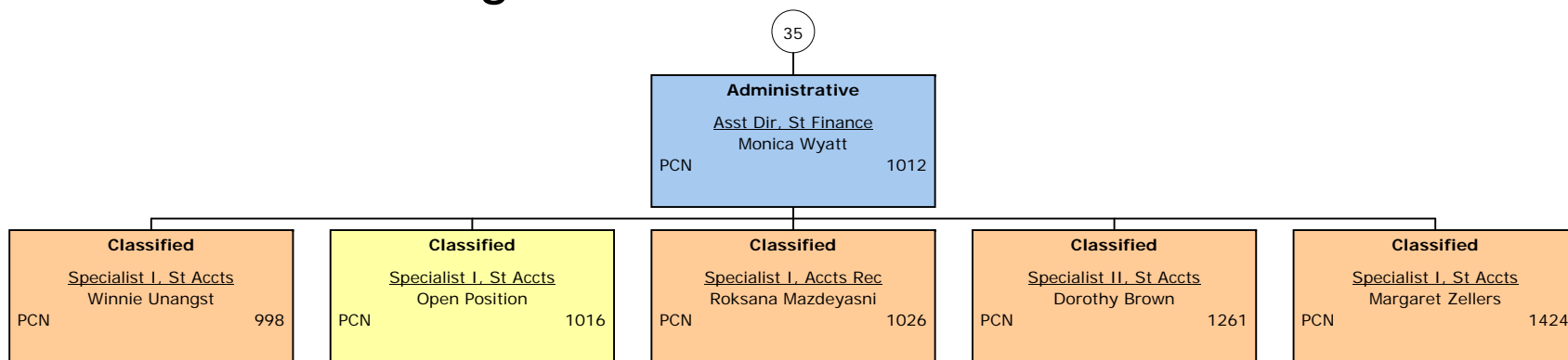

Organizational Chart FY 2017

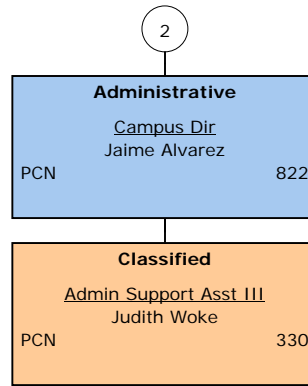

Organizational Chart FY 2017

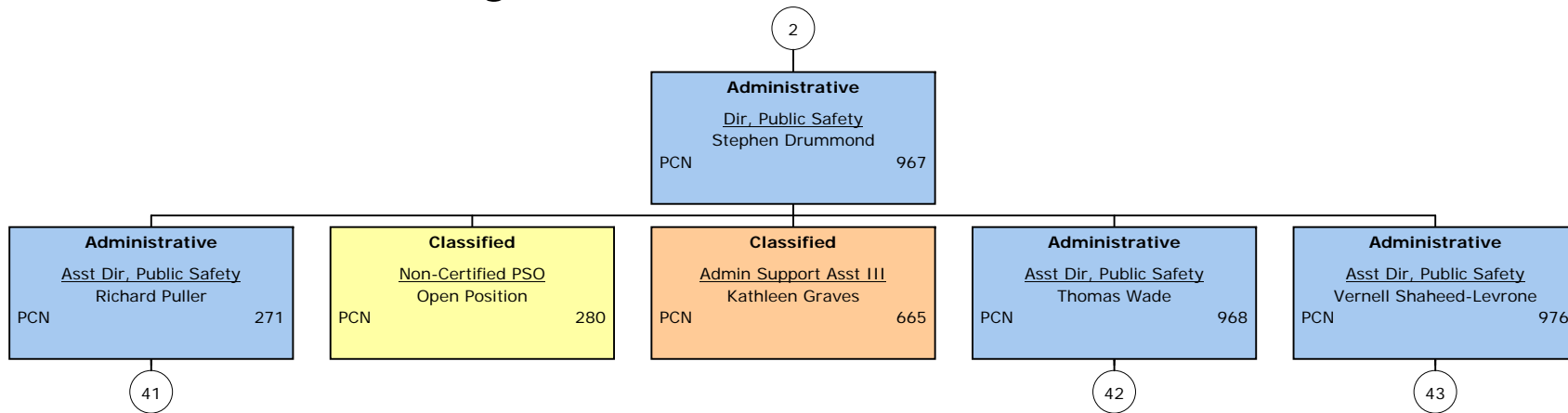

Organizational Chart FY 2017

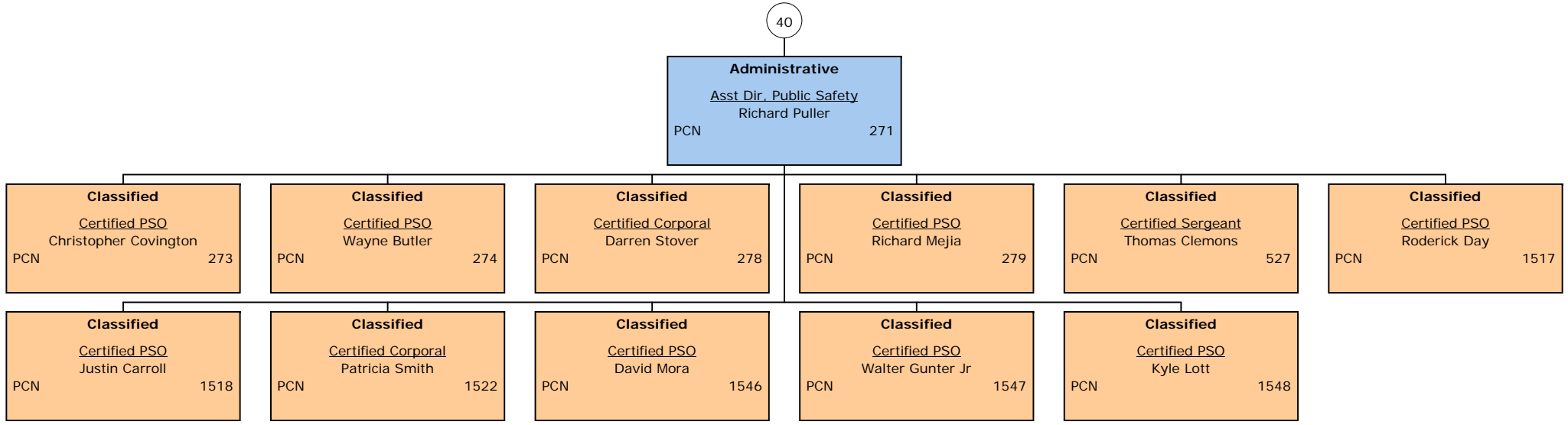

Organizational Chart FY 2017

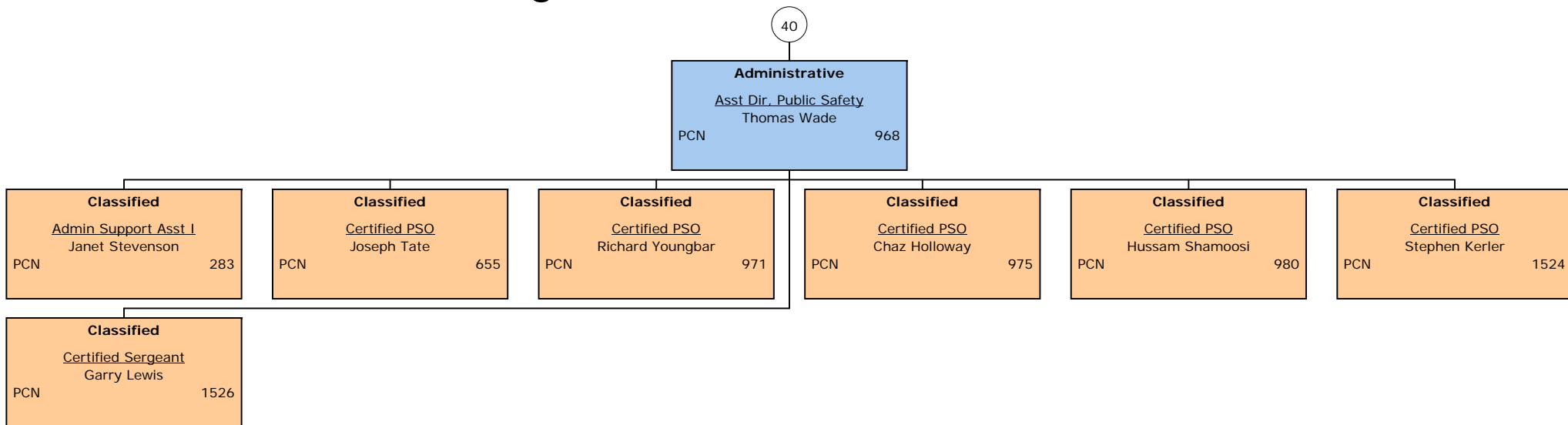

Organizational Chart FY 2017

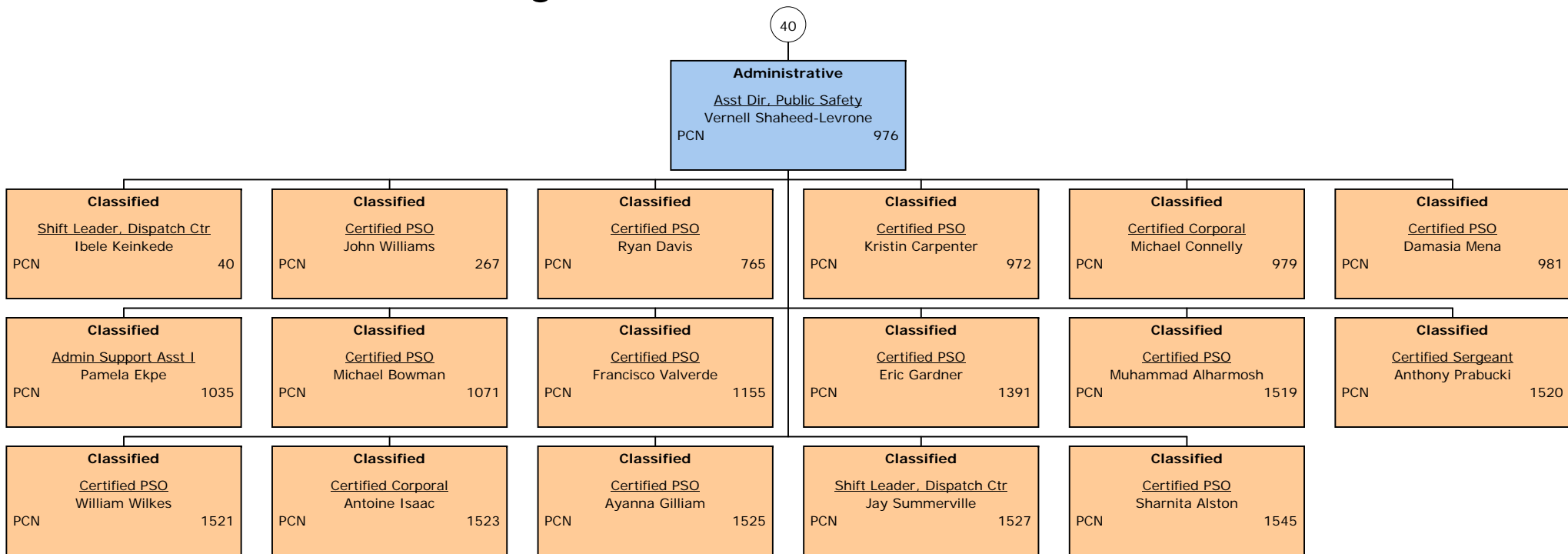

Organizational Chart FY 2017

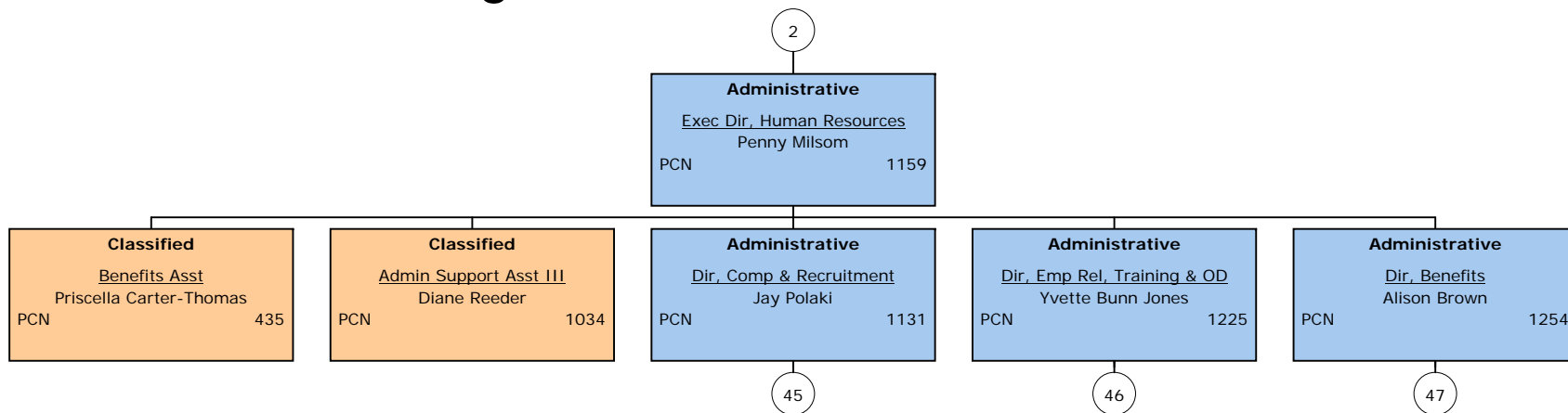

Organizational Chart FY 2017

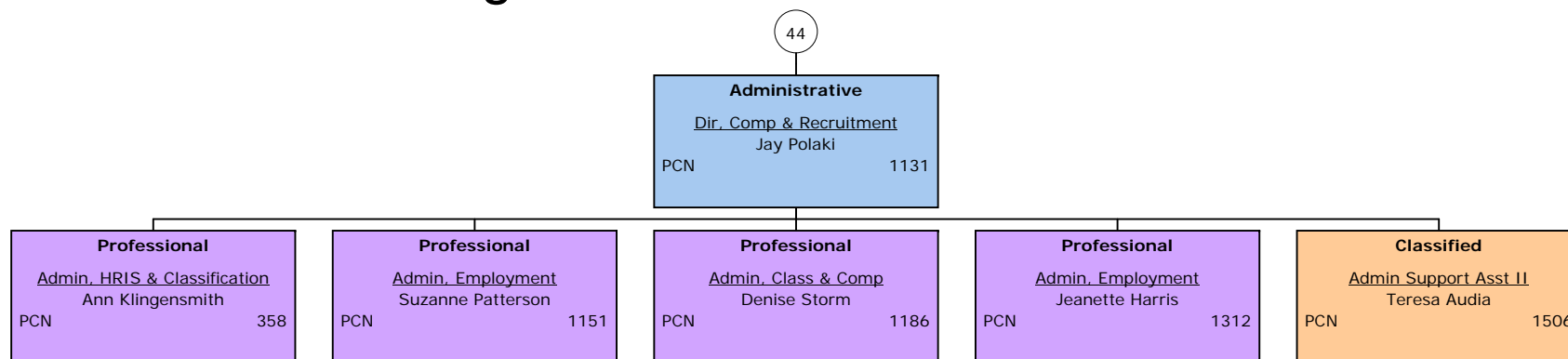

Organizational Chart FY 2017

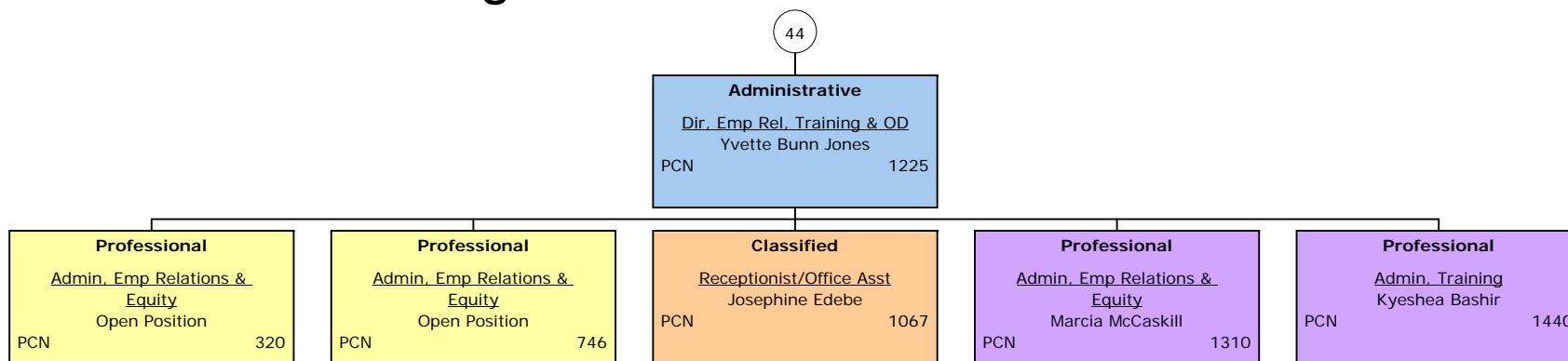

Organizational Chart FY 2017

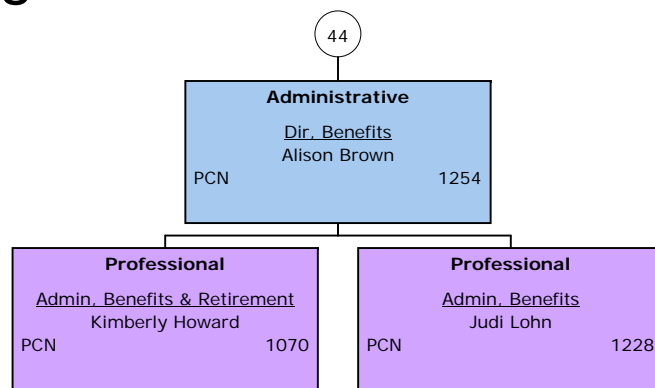

Organizational Chart FY 2017

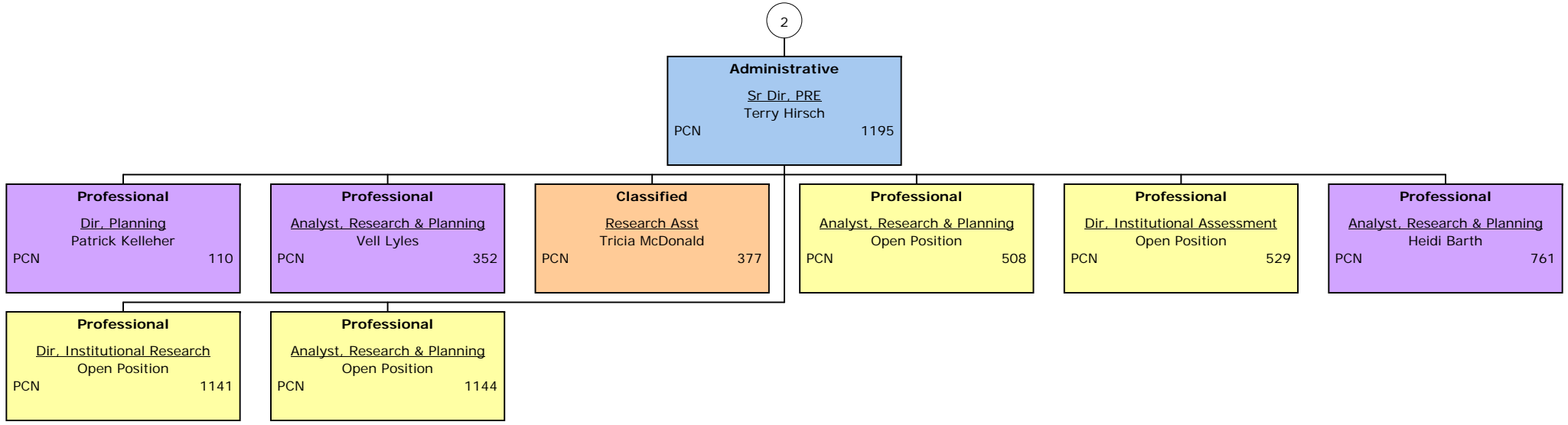

Organizational Chart FY 2017

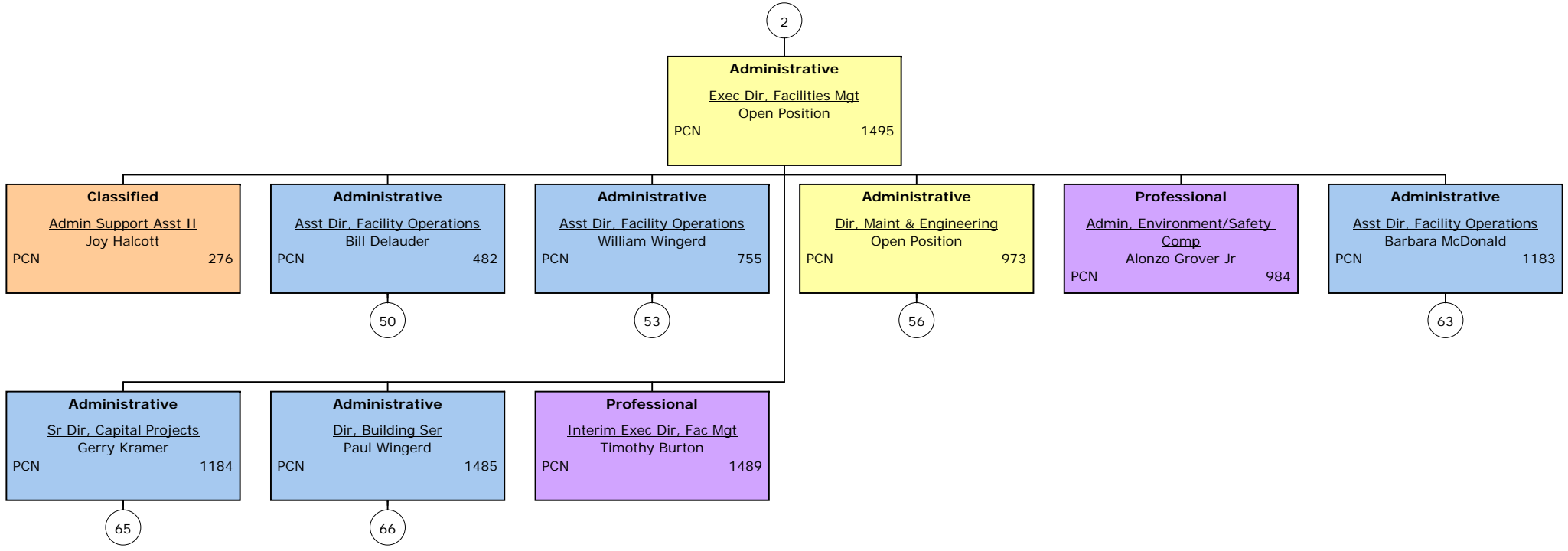

Organizational Chart FY 2017

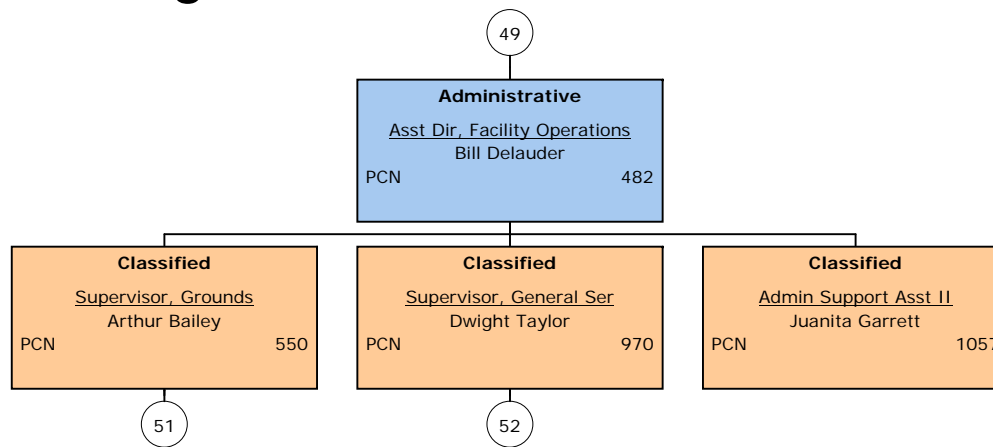

Organizational Chart FY 2017

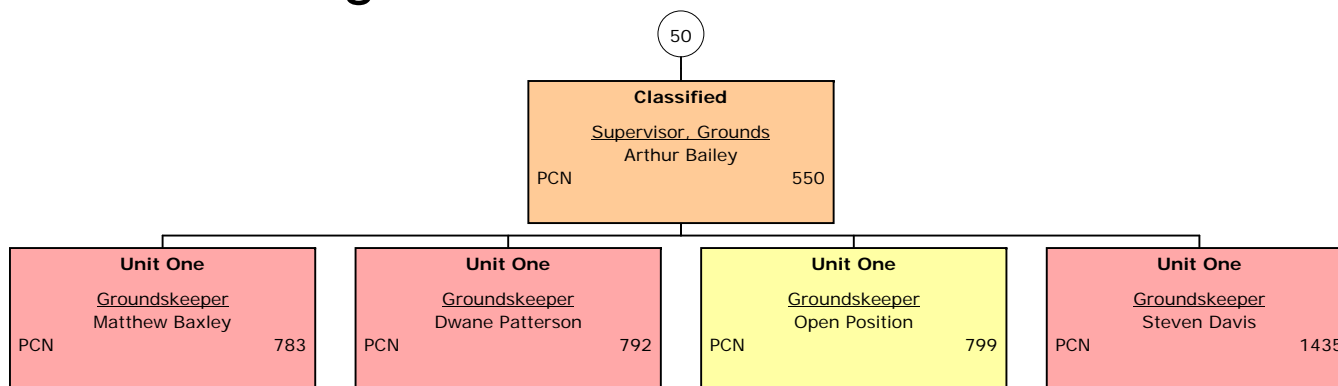

Organizational Chart FY 2017

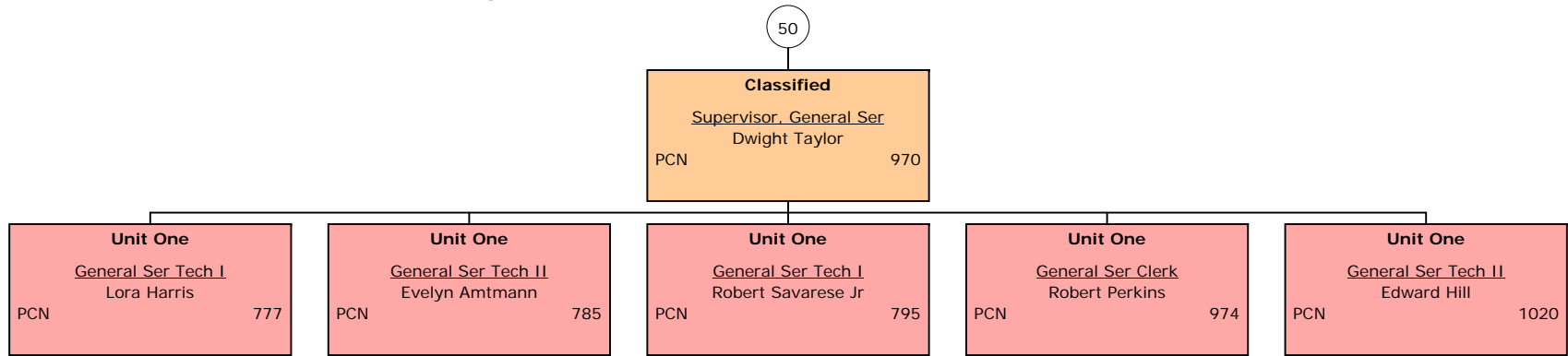

Organizational Chart FY 2017

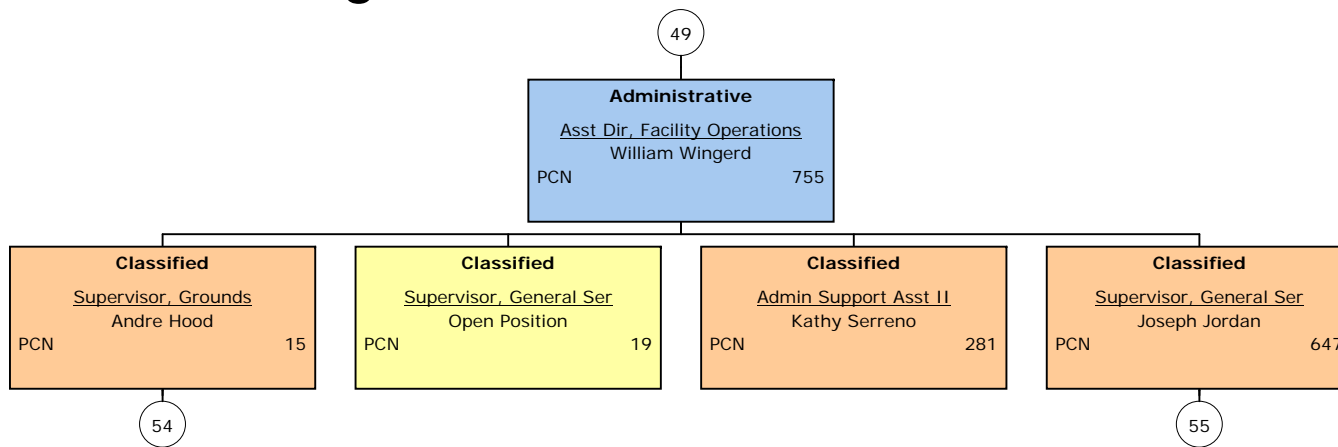

Organizational Chart FY 2017

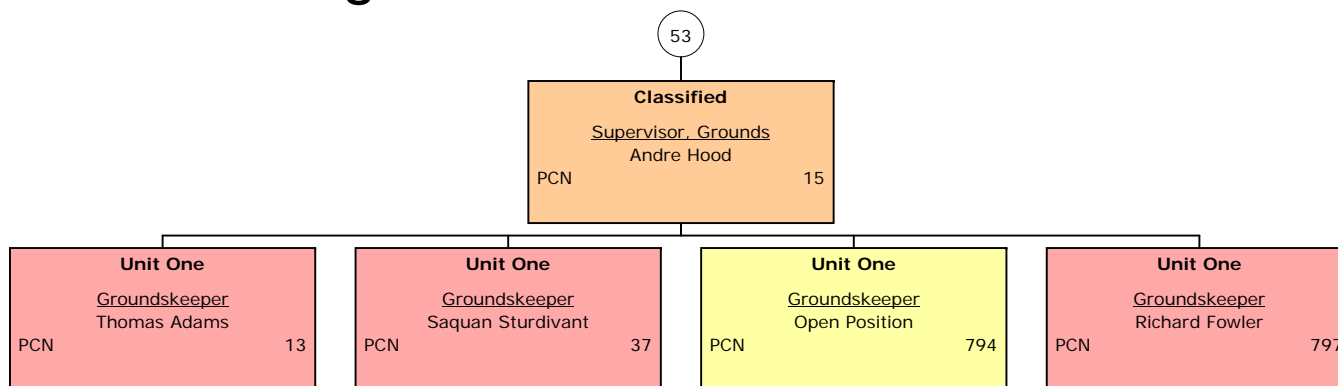

Organizational Chart FY 2017

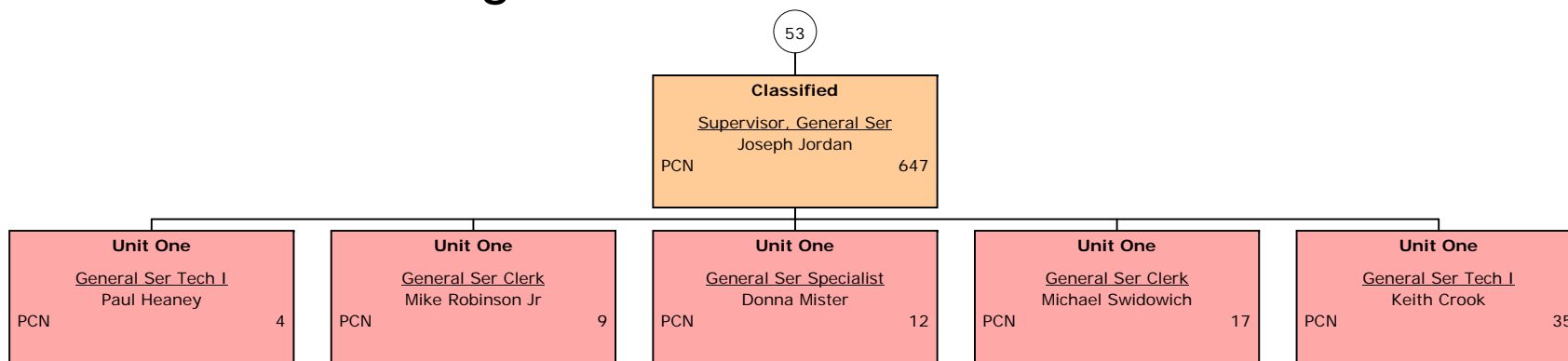

Organizational Chart FY 2017

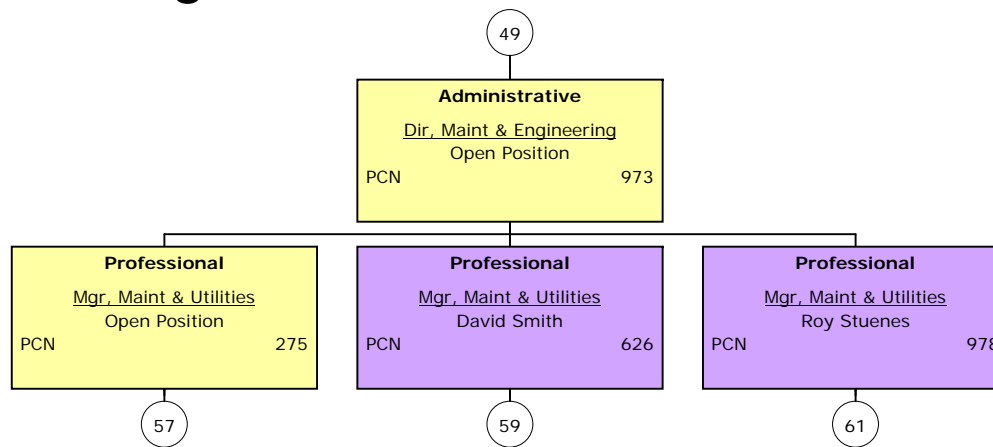

Organizational Chart FY 2017

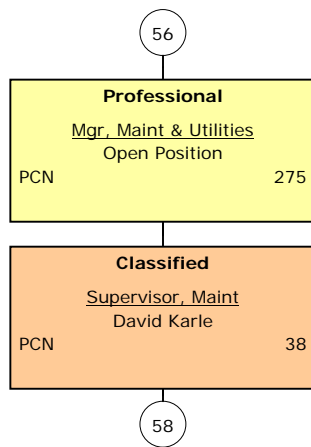

Organizational Chart FY 2017

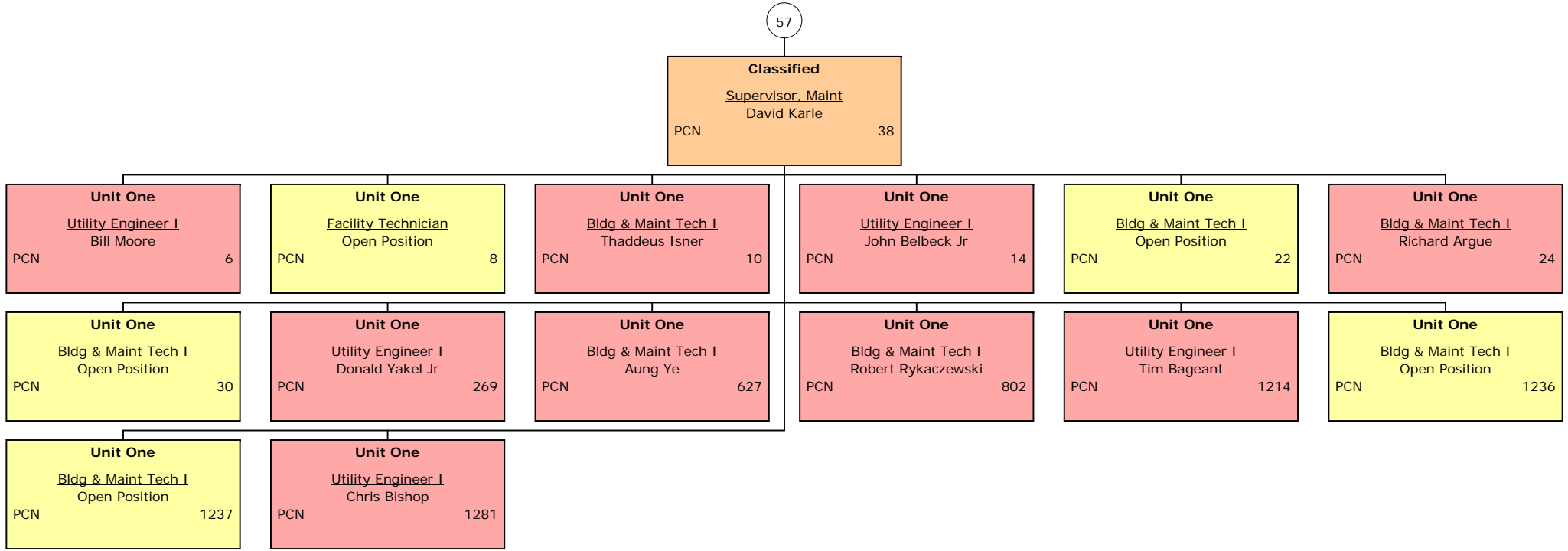

Organizational Chart FY 2017

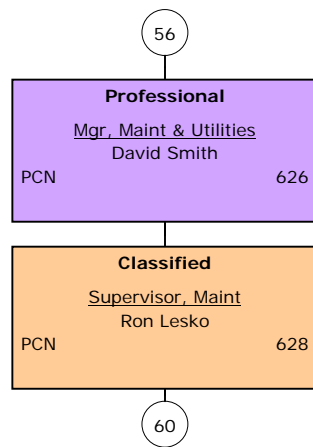

Organizational Chart FY 2017

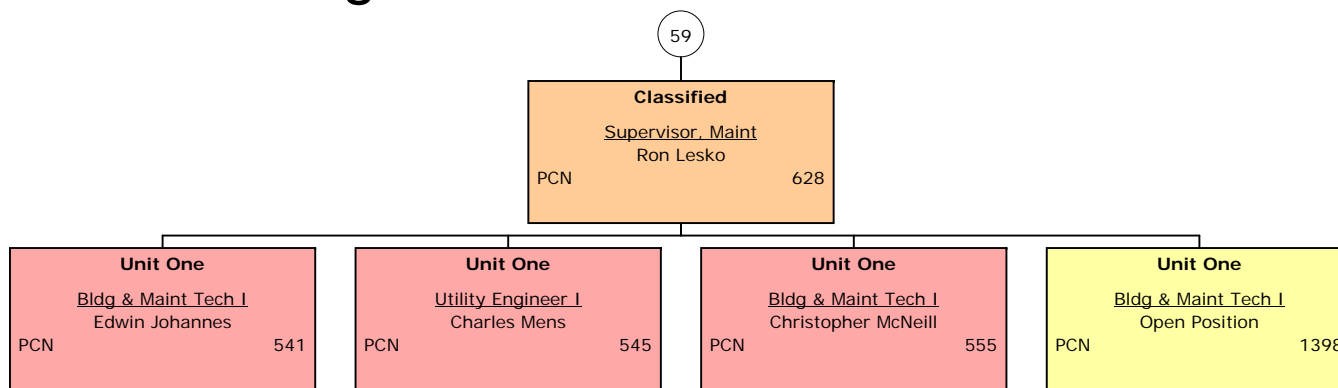

Organizational Chart FY 2017

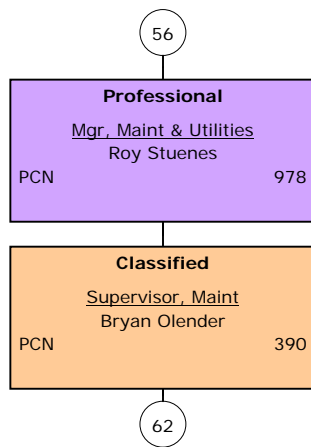

Organizational Chart FY 2017

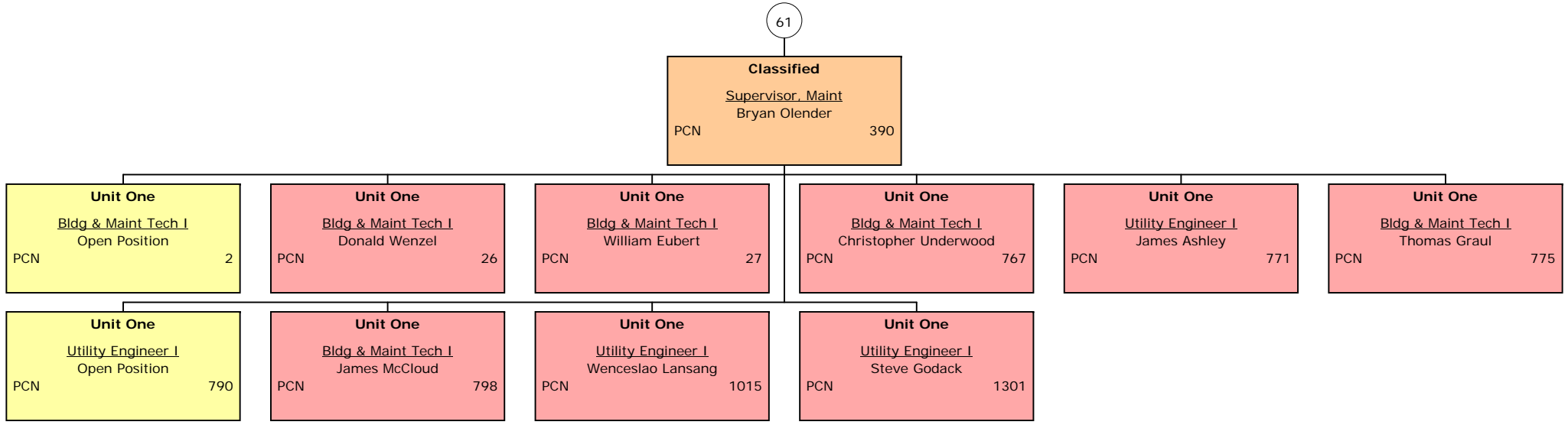

Organizational Chart FY 2017

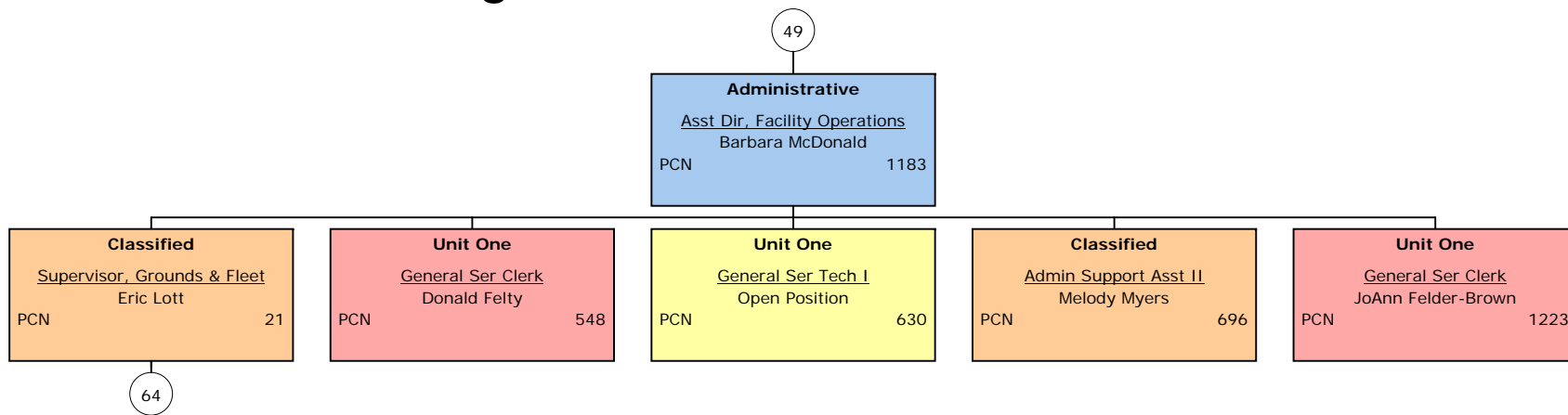

Organizational Chart FY 2017

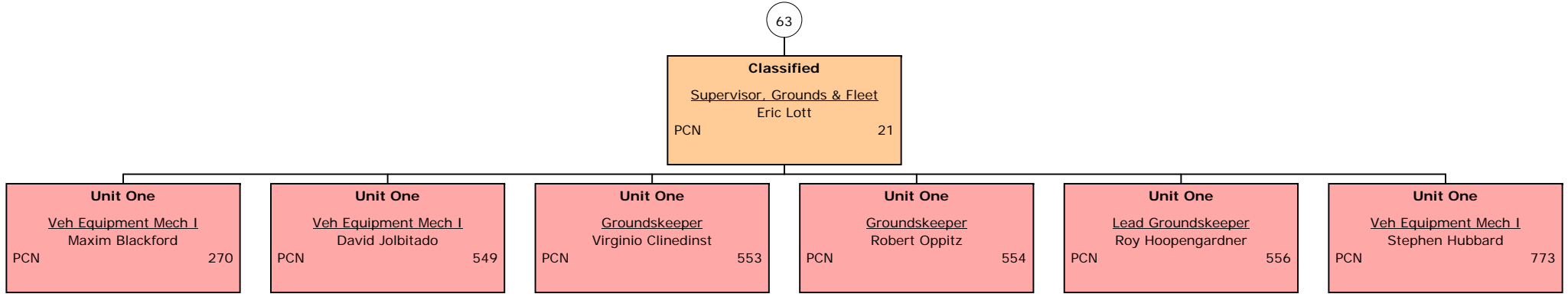

Organizational Chart FY 2017

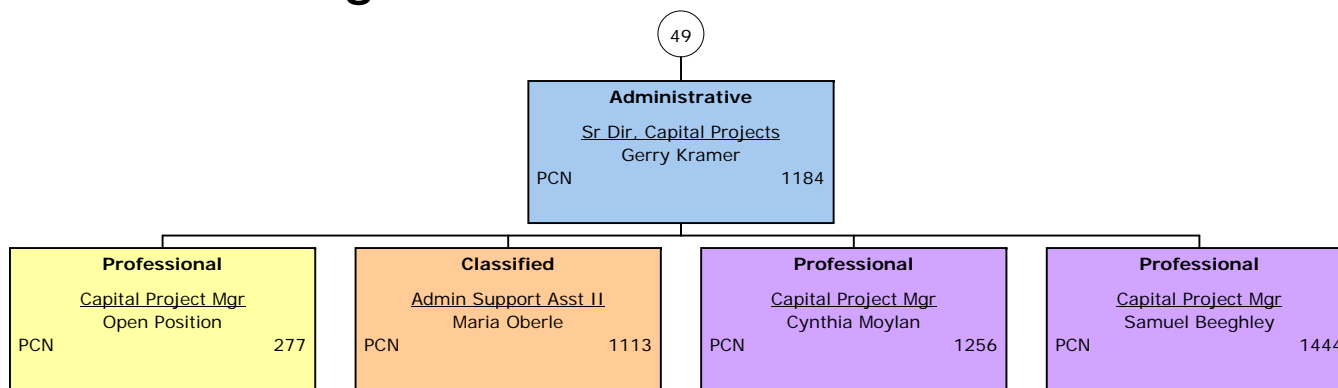

Organizational Chart FY 2017

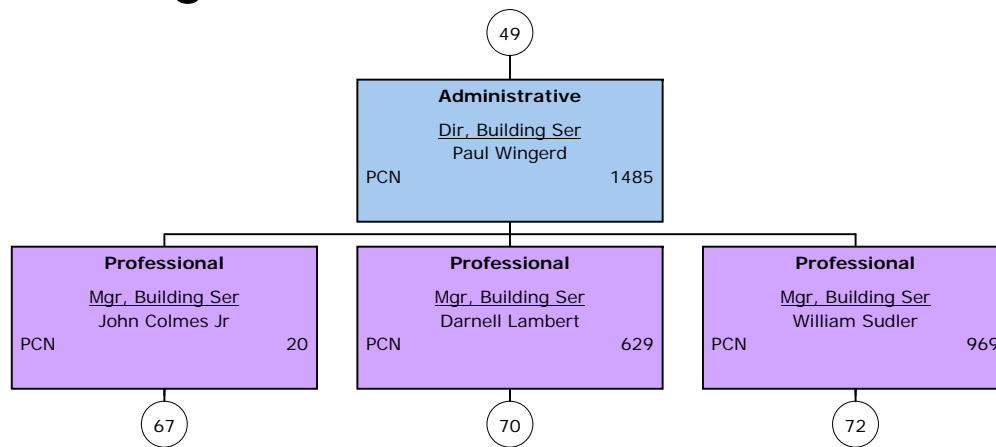

Organizational Chart FY 2017

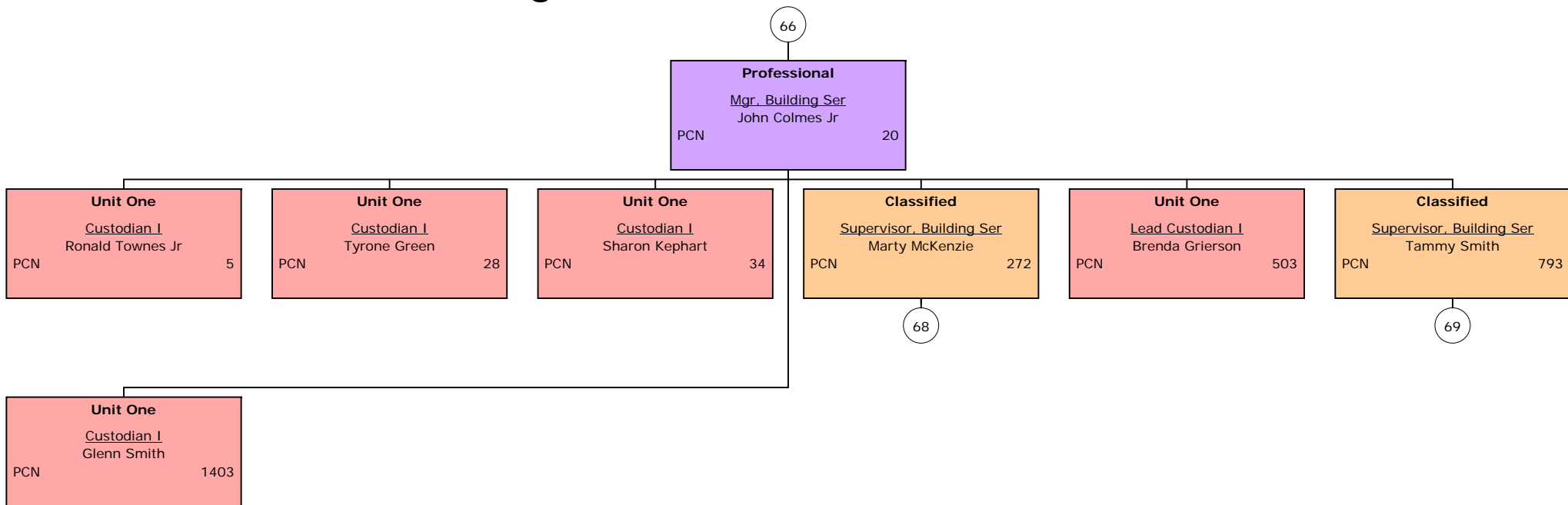

Organizational Chart FY 2017

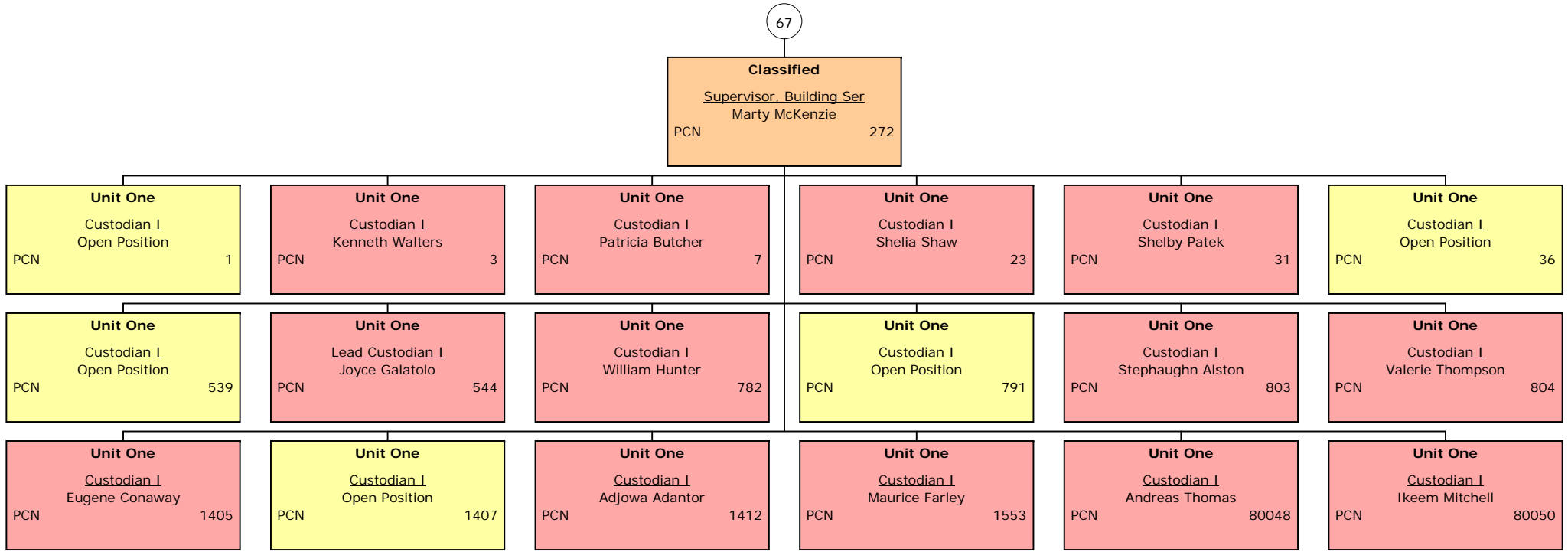

Organizational Chart FY 2017

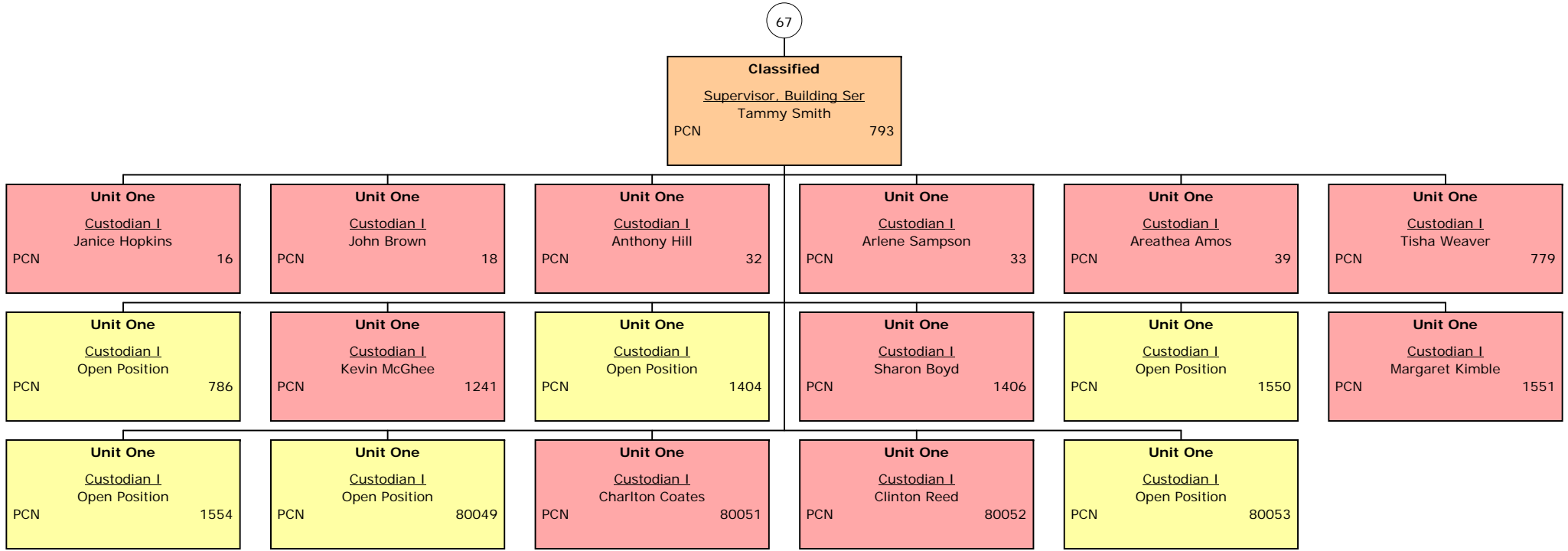

Organizational Chart FY 2017

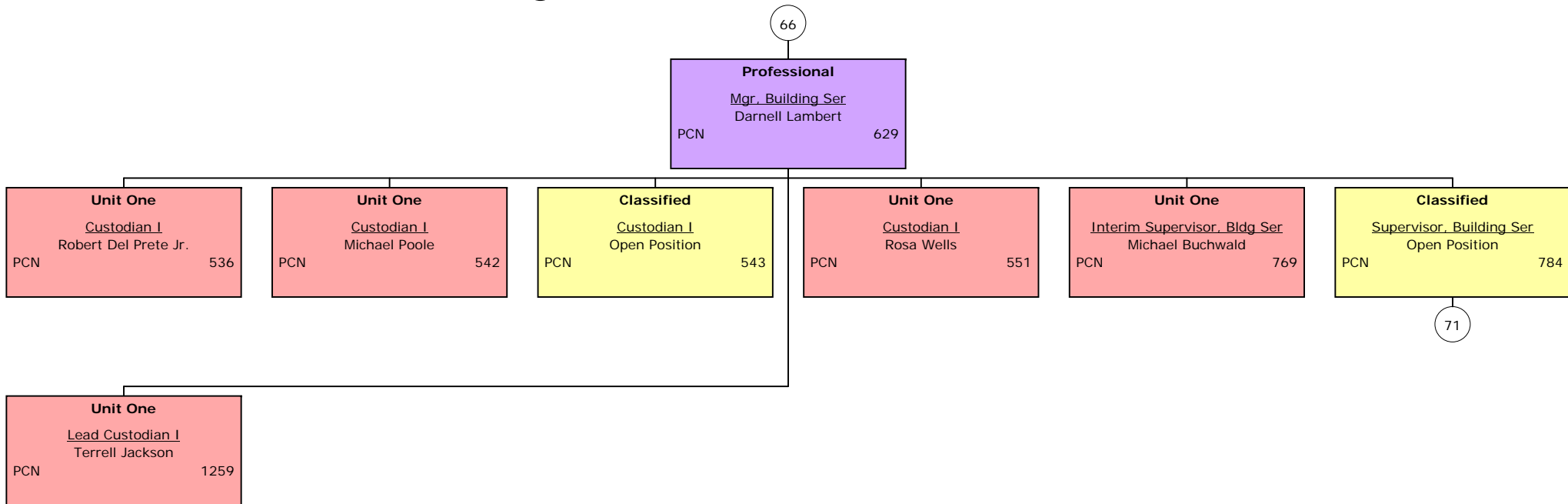

Organizational Chart FY 2017

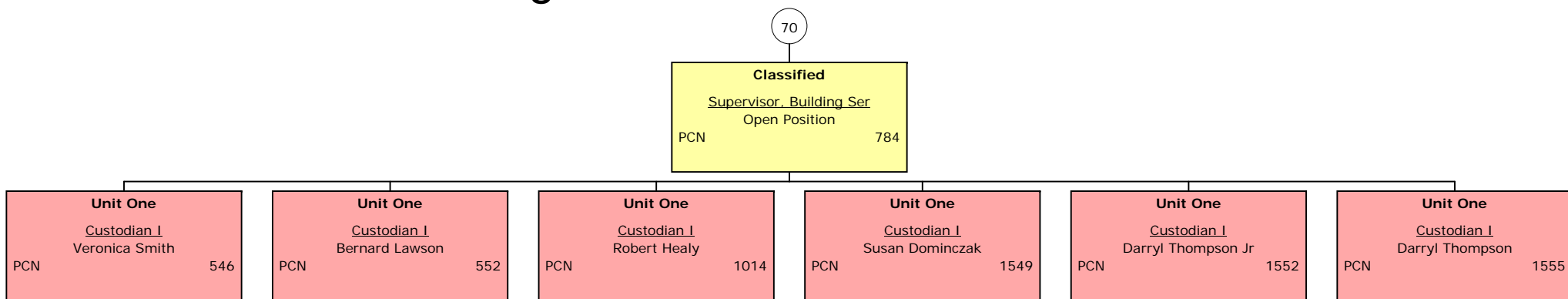

Organizational Chart FY 2017

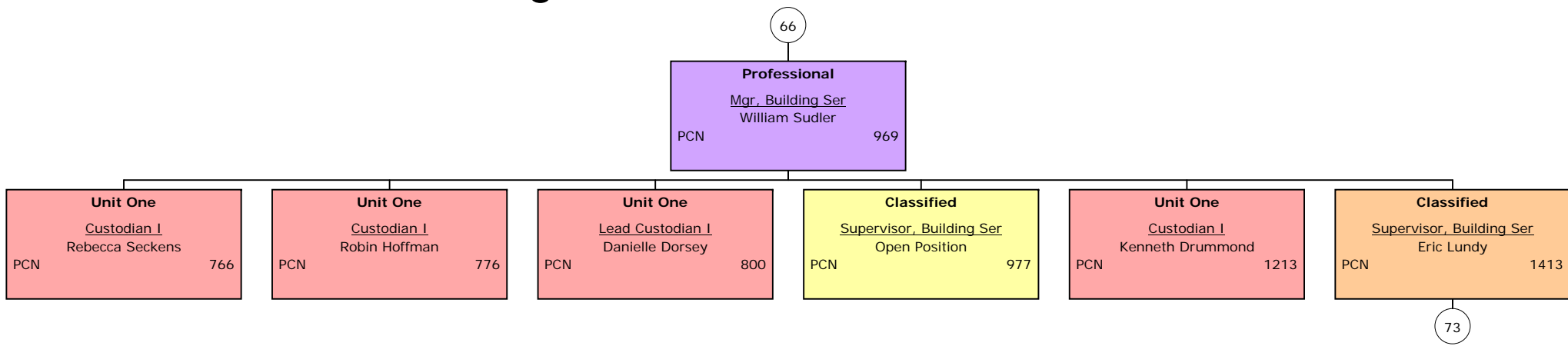

Organizational Chart FY 2017

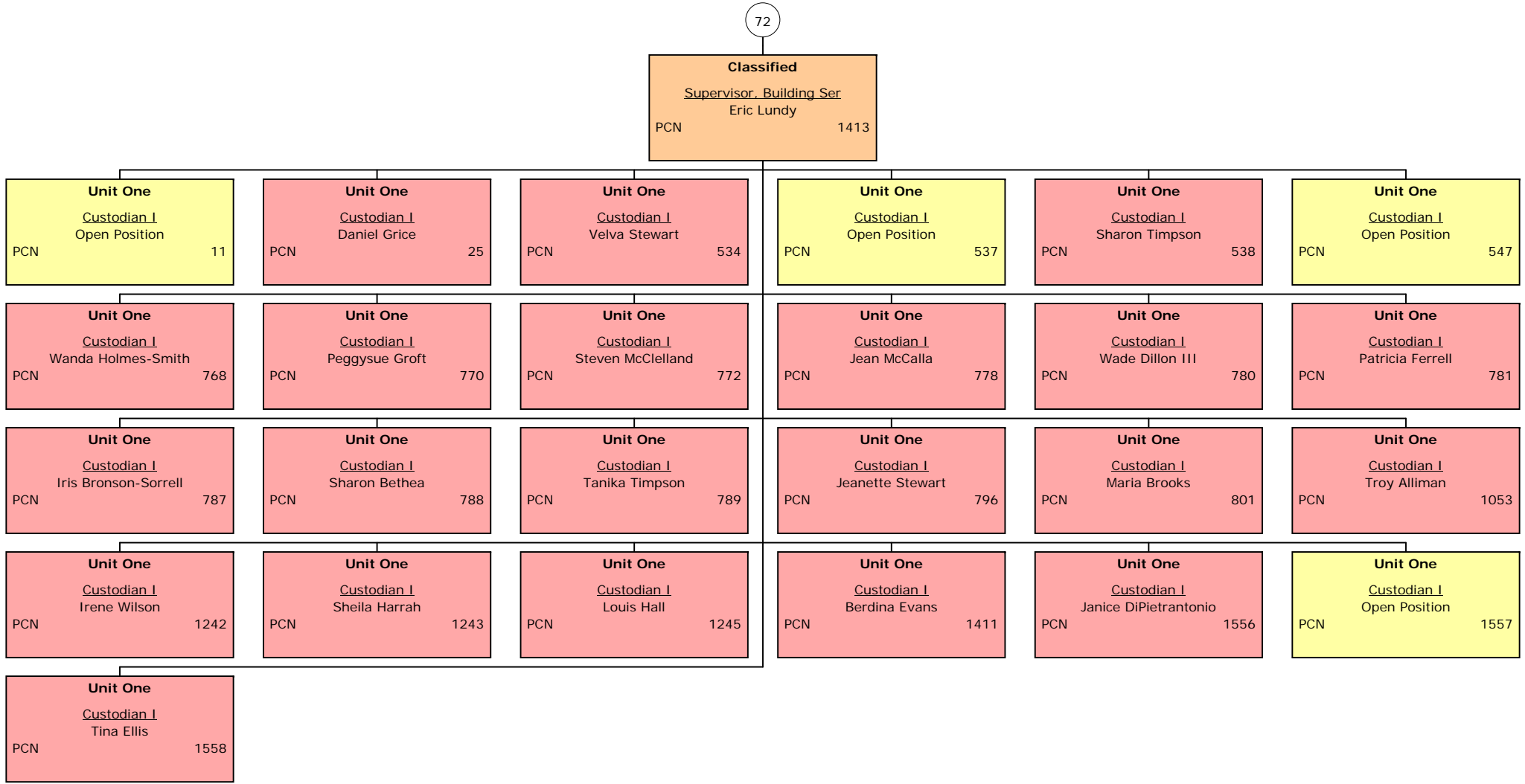

Organizational Chart FY 2017

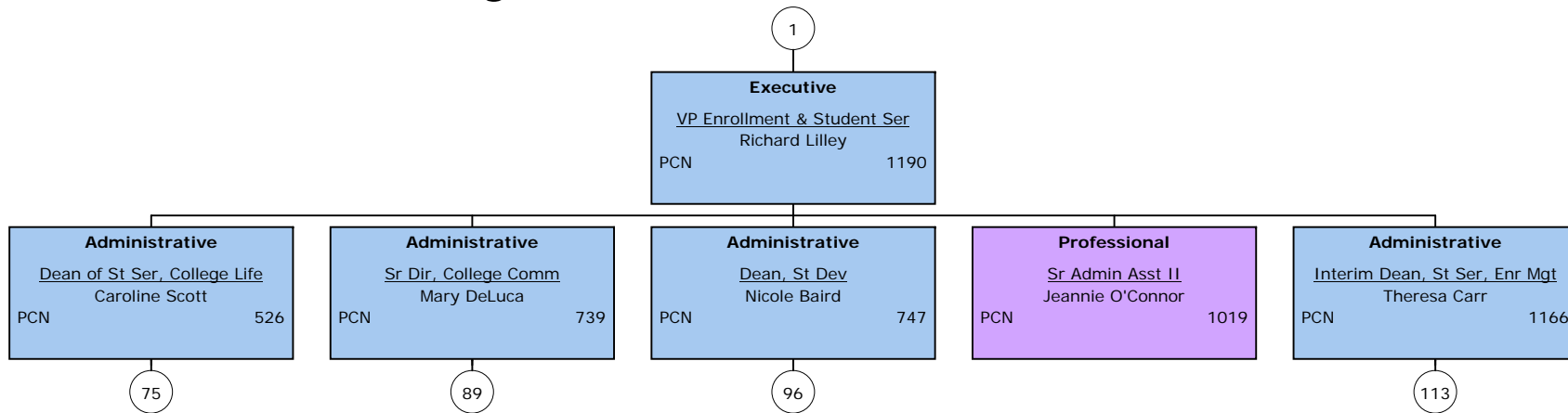

Organizational Chart FY 2017

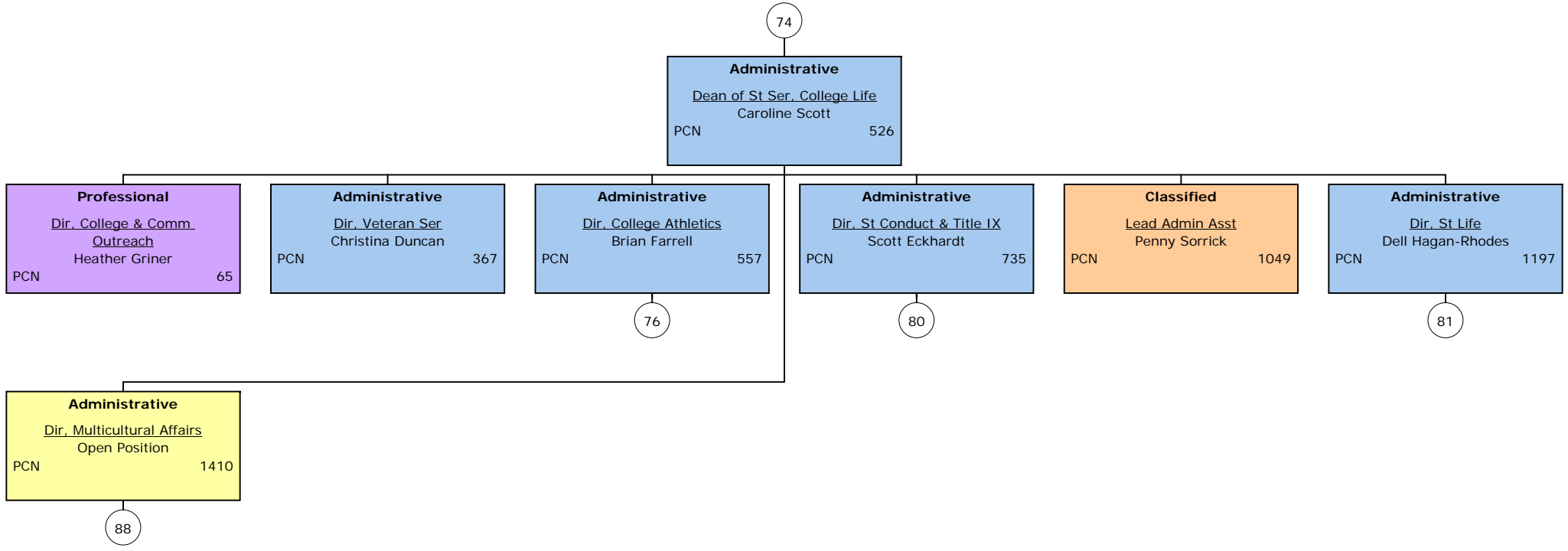

Organizational Chart FY 2017

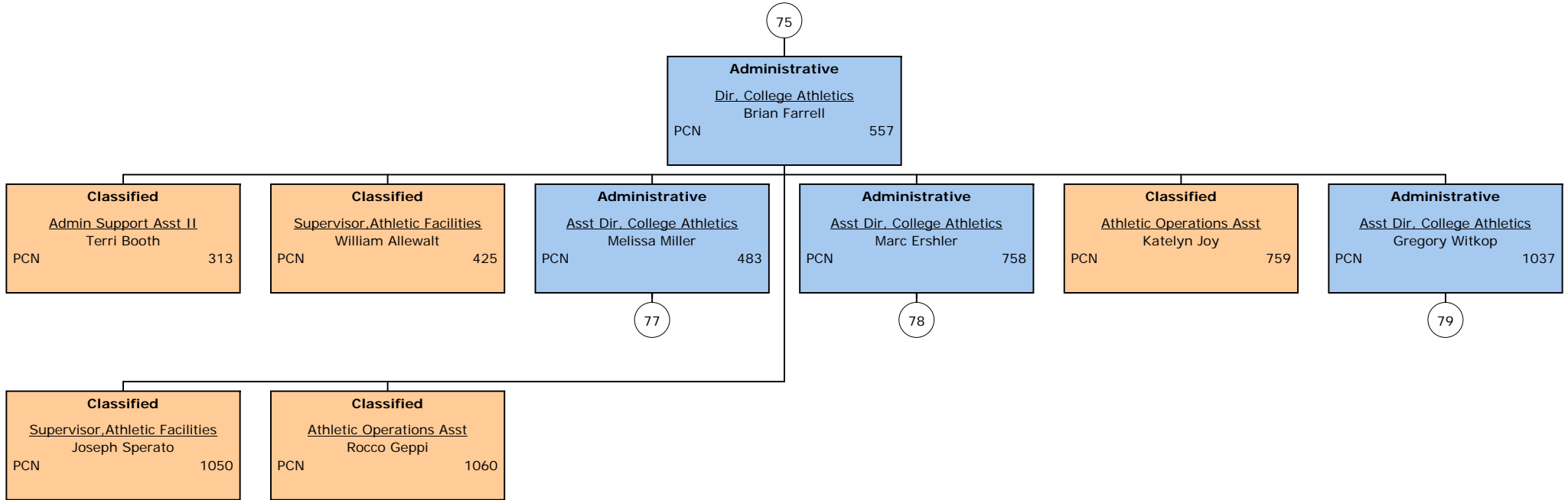

Organizational Chart FY 2017

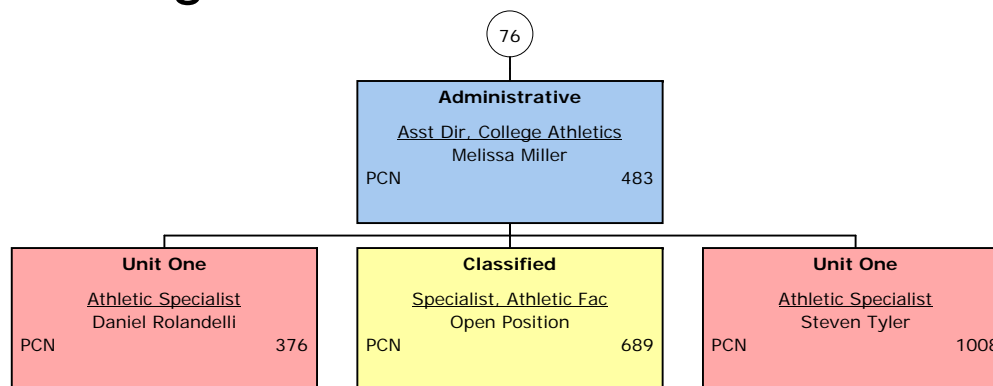

Organizational Chart FY 2017

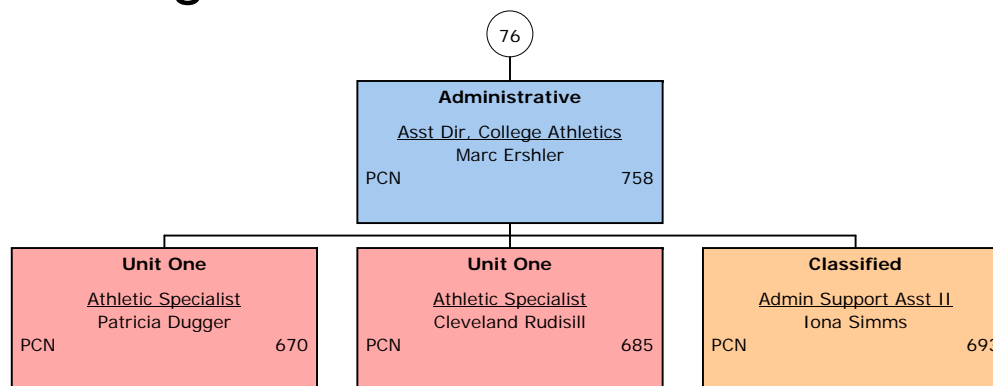

Organizational Chart FY 2017

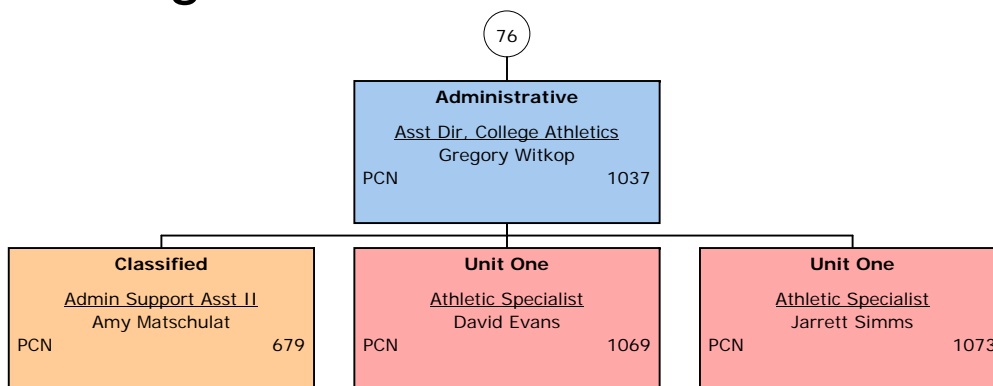

Organizational Chart FY 2017

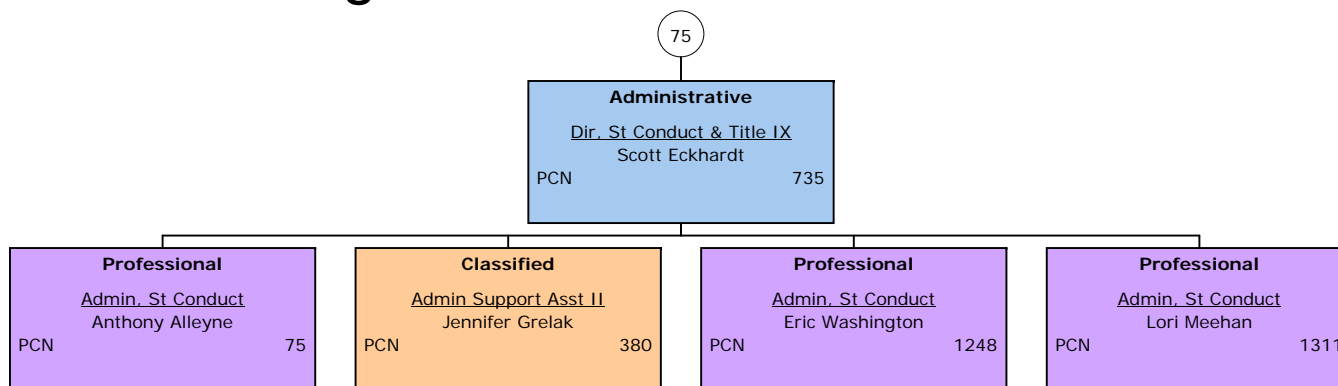

Organizational Chart FY 2017

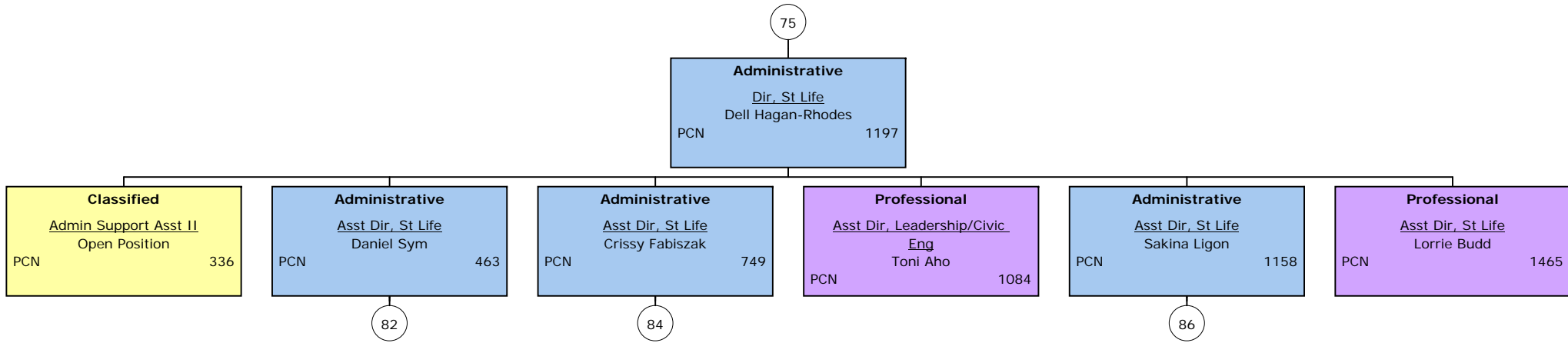

Organizational Chart FY 2017

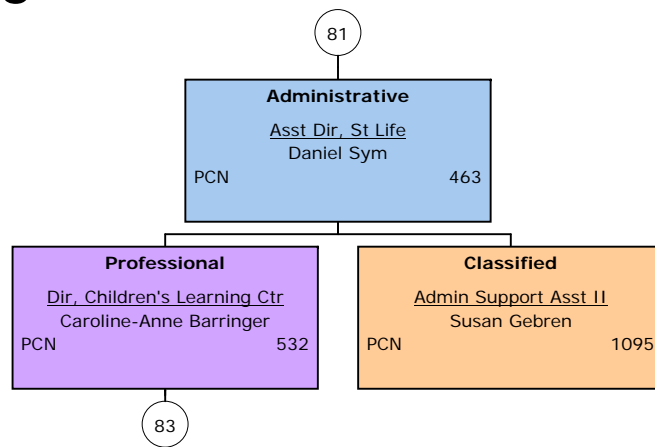

Organizational Chart FY 2017

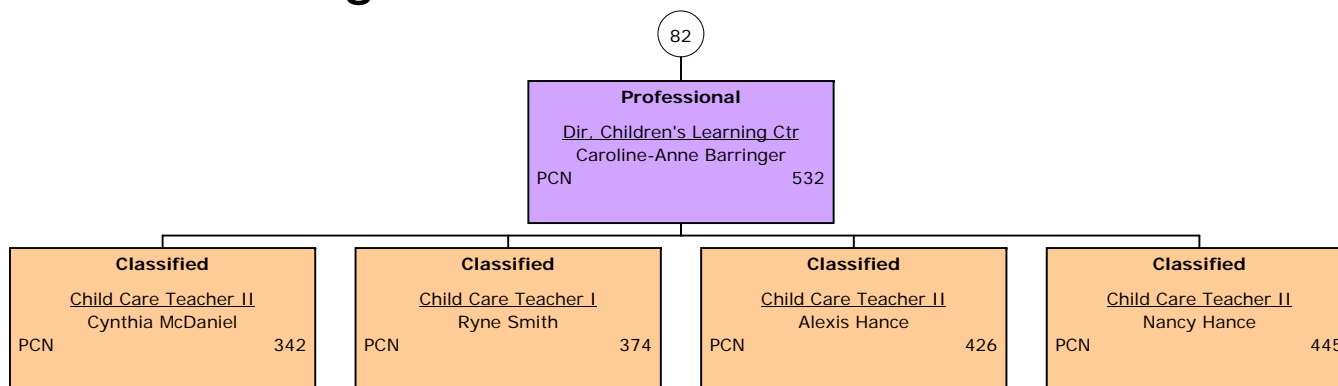

Organizational Chart FY 2017

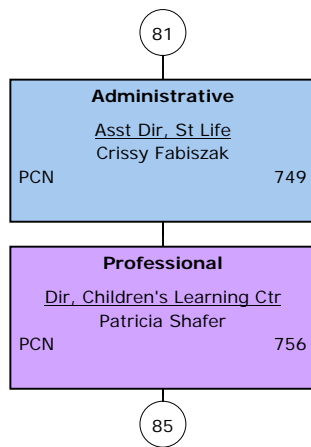

Organizational Chart FY 2017

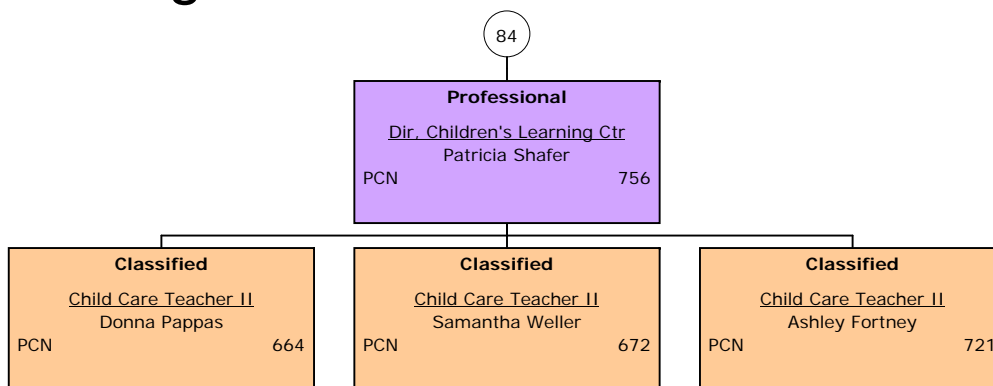

Organizational Chart FY 2017

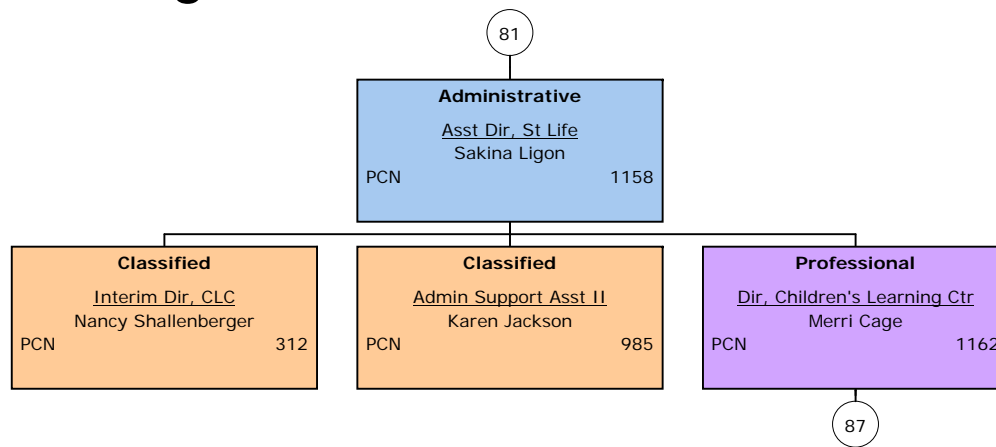

Organizational Chart FY 2017

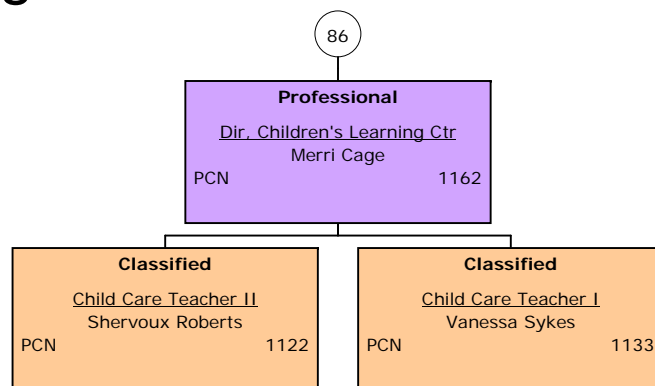

Organizational Chart FY 2017

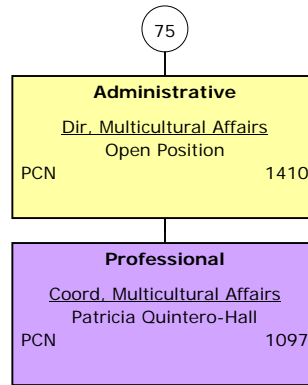

Organizational Chart FY 2017

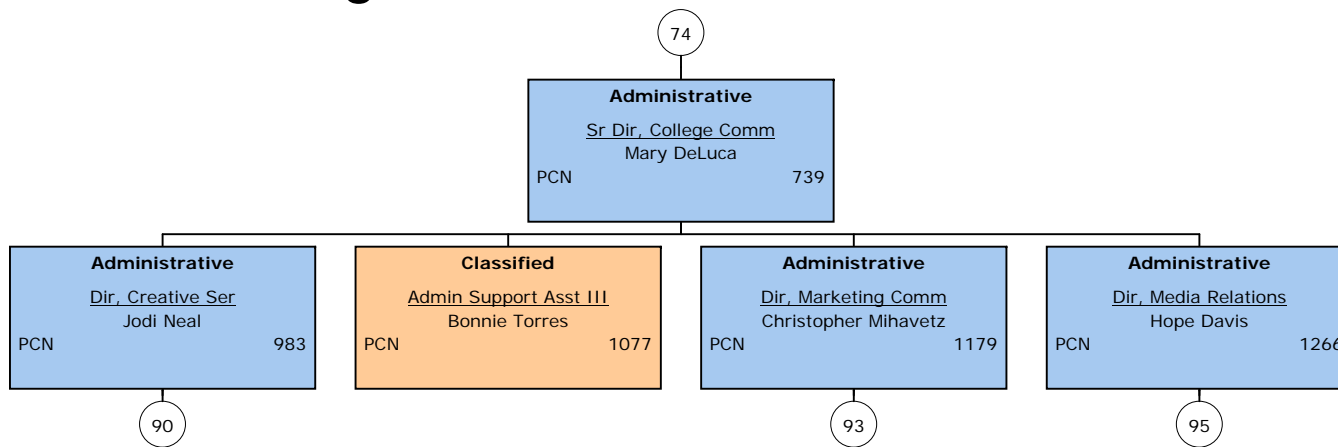

Organizational Chart FY 2017

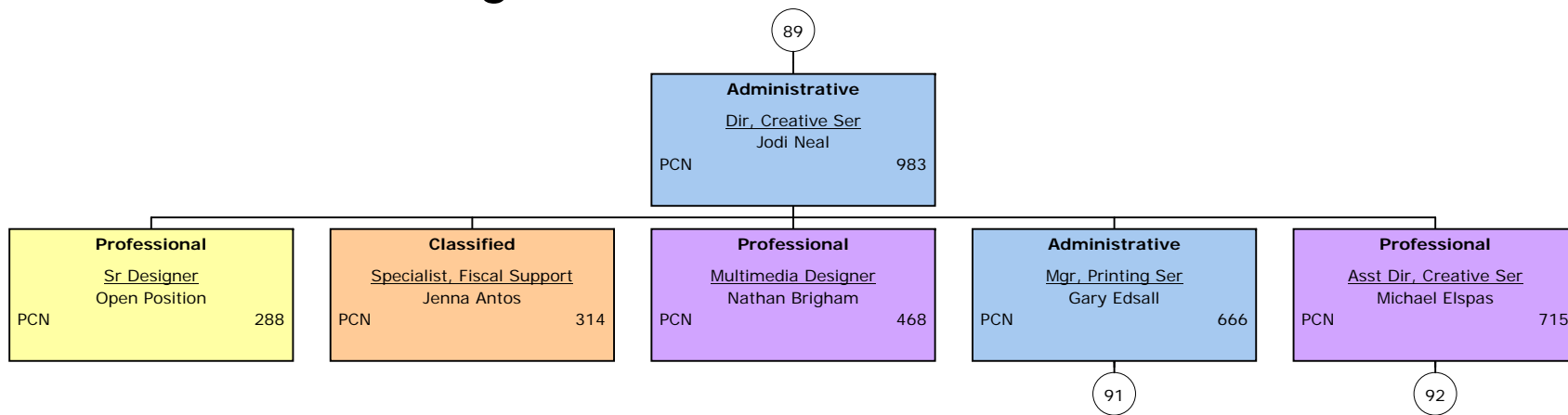

Organizational Chart FY 2017

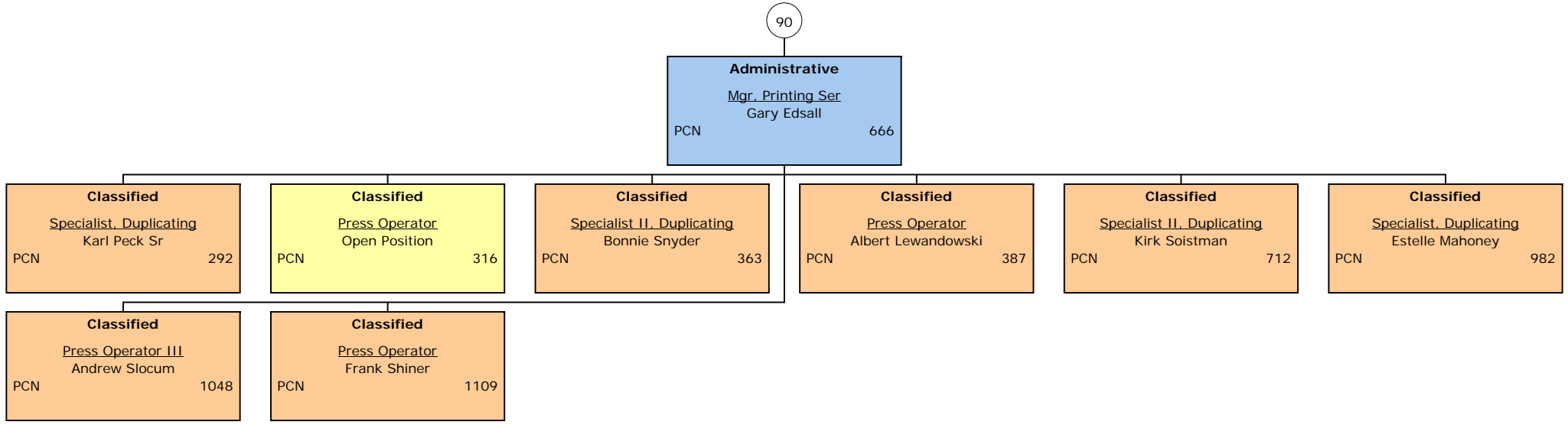

Organizational Chart FY 2017

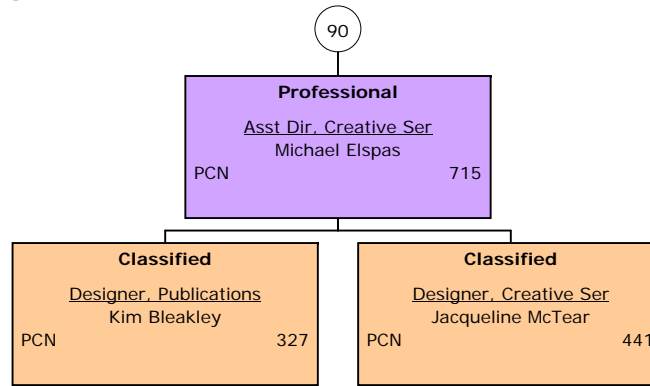

Organizational Chart FY 2017

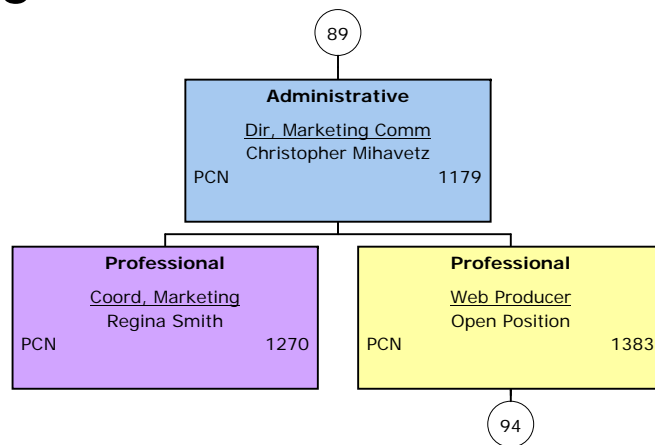

Organizational Chart FY 2017

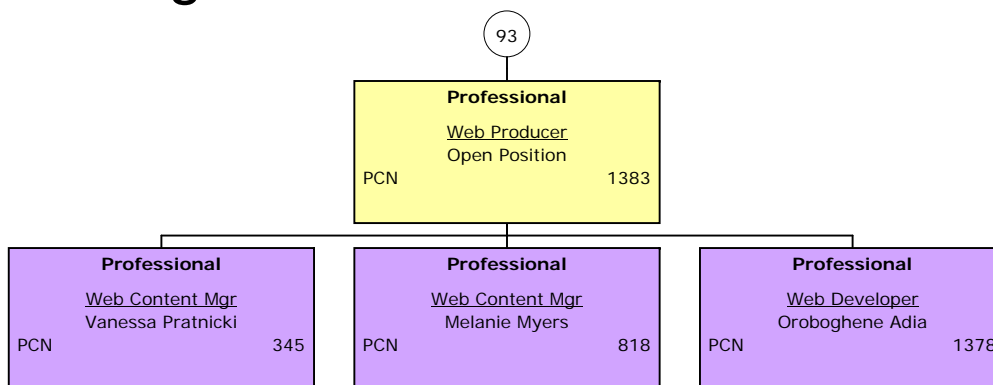

Organizational Chart FY 2017

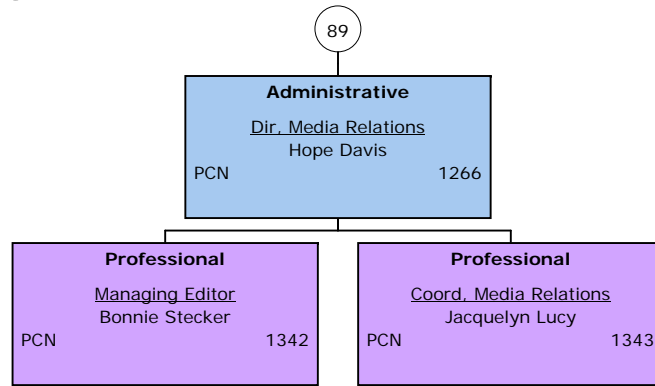

Organizational Chart FY 2017

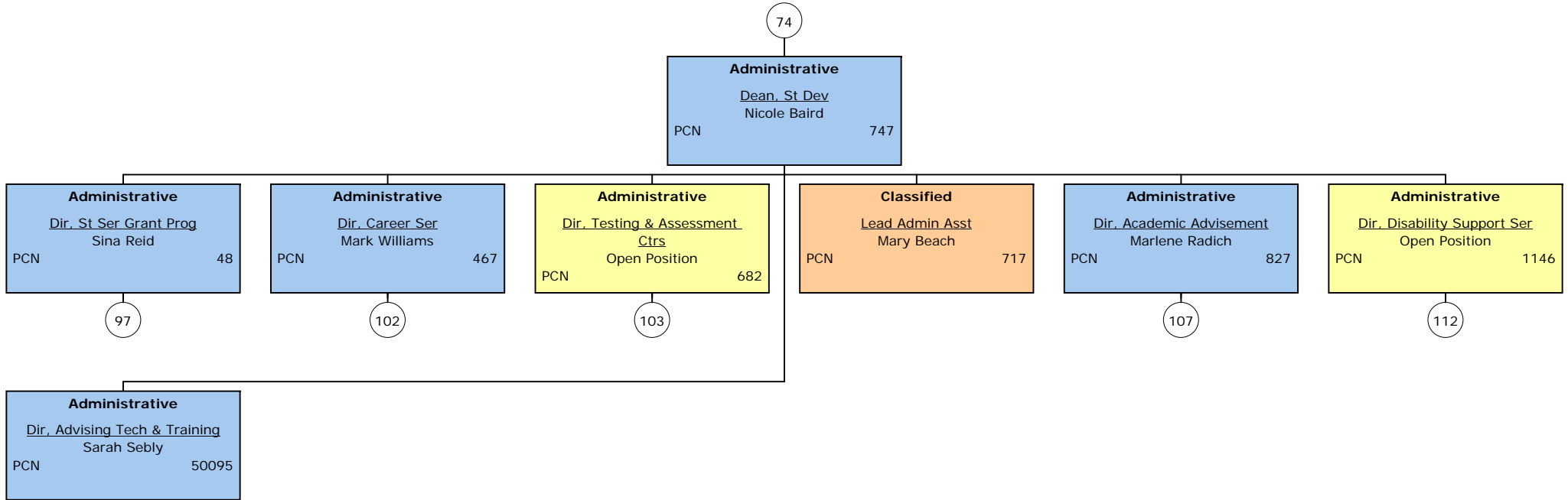

Organizational Chart FY 2017

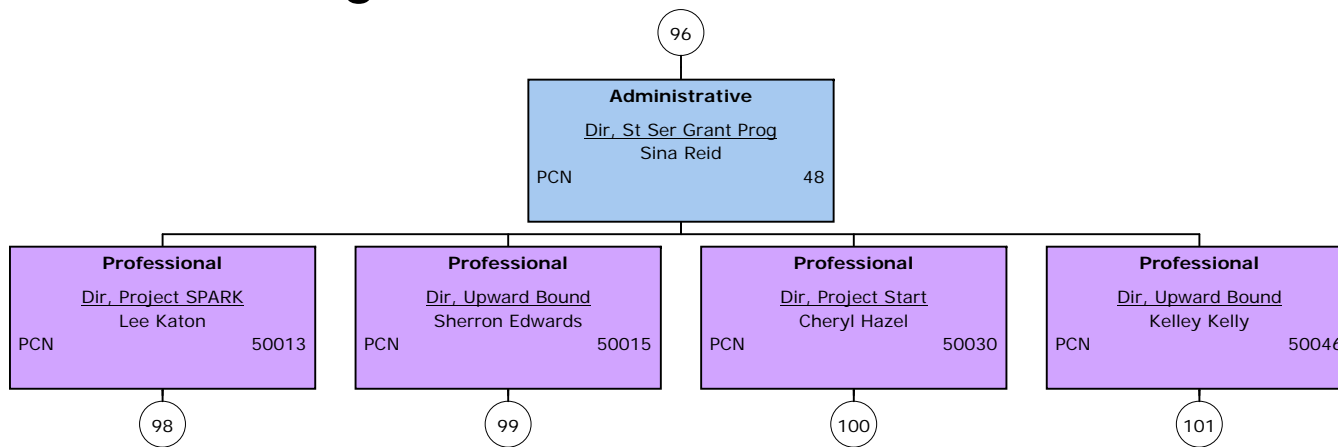

Organizational Chart FY 2017

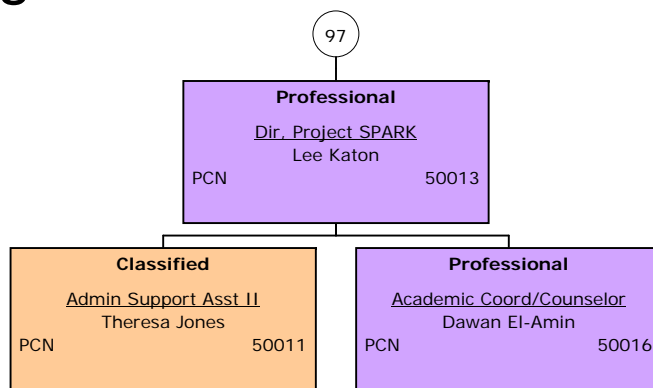

Organizational Chart FY 2017

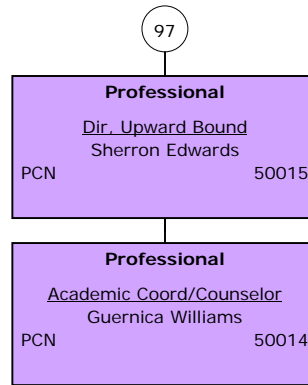

Organizational Chart FY 2017

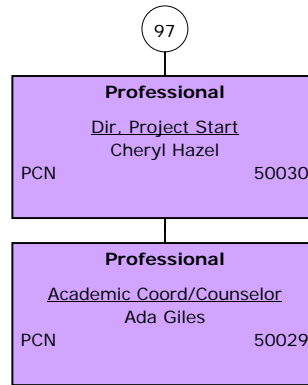

Organizational Chart FY 2017

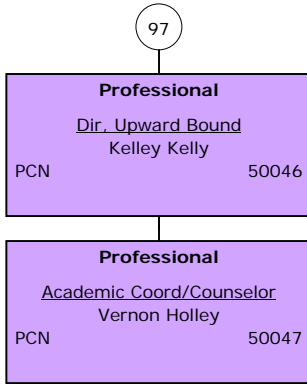

Organizational Chart FY 2017

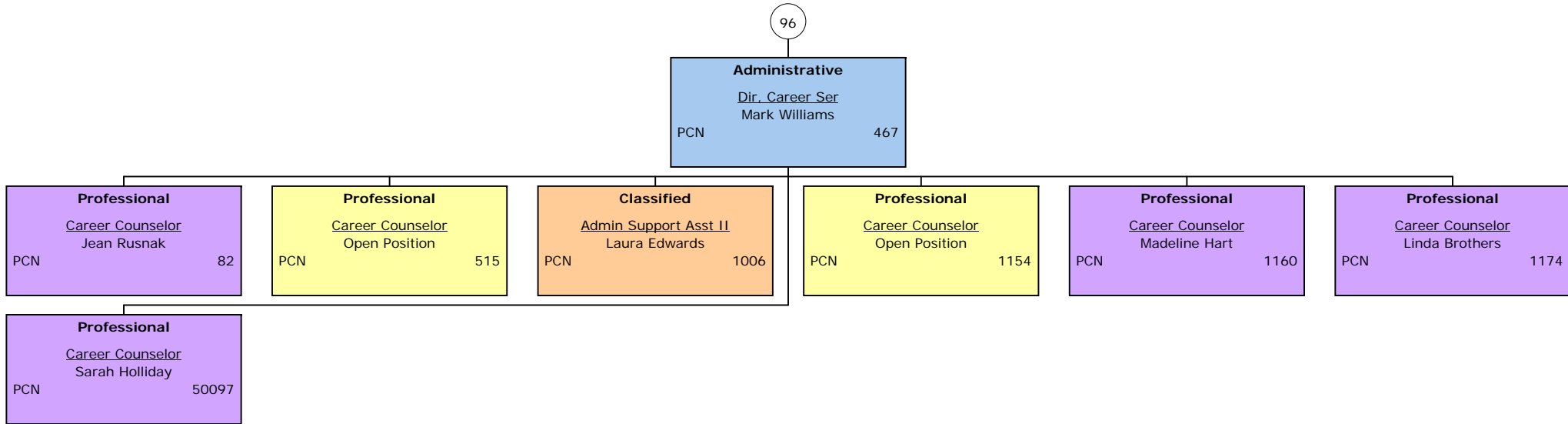

Organizational Chart FY 2017

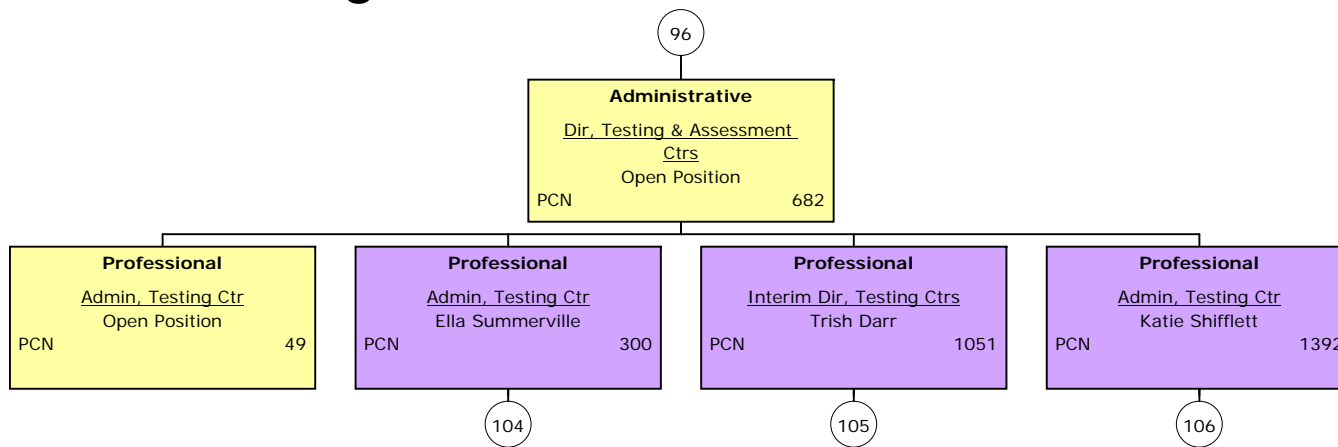

Organizational Chart FY 2017

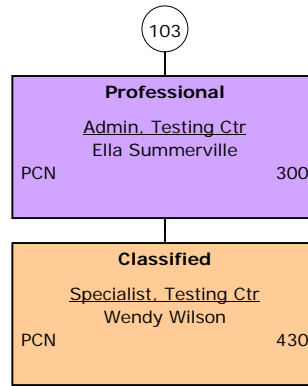

Organizational Chart FY 2017

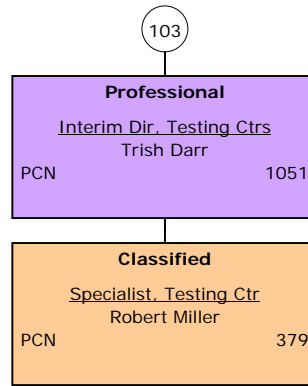

Organizational Chart FY 2017

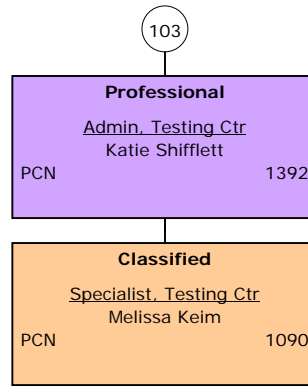

Organizational Chart FY 2017

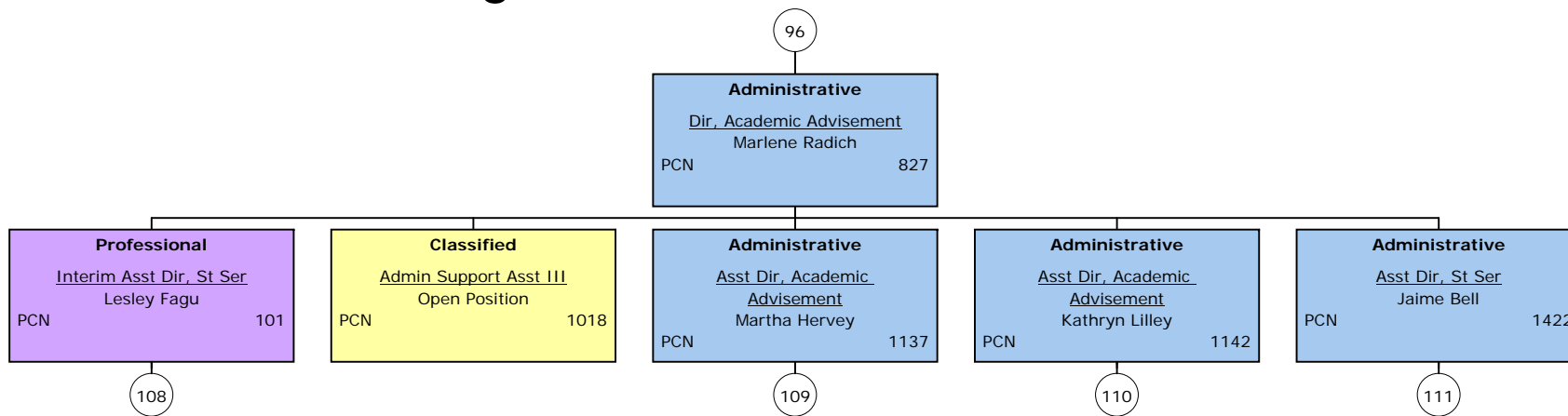

Organizational Chart FY 2017

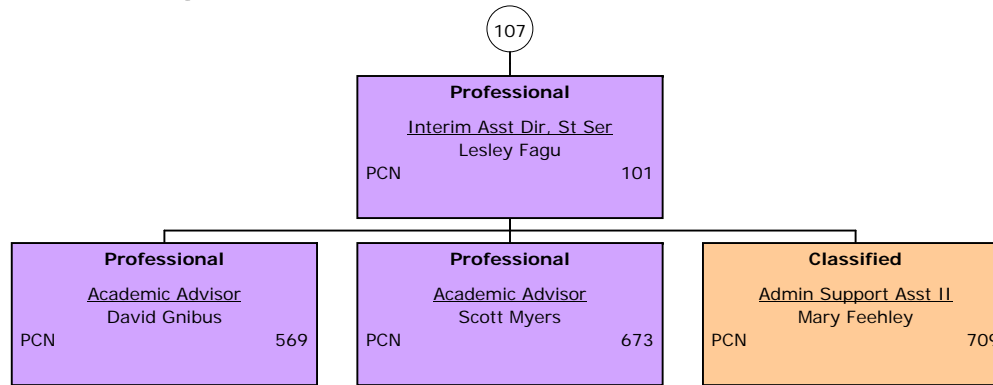

Organizational Chart FY 2017

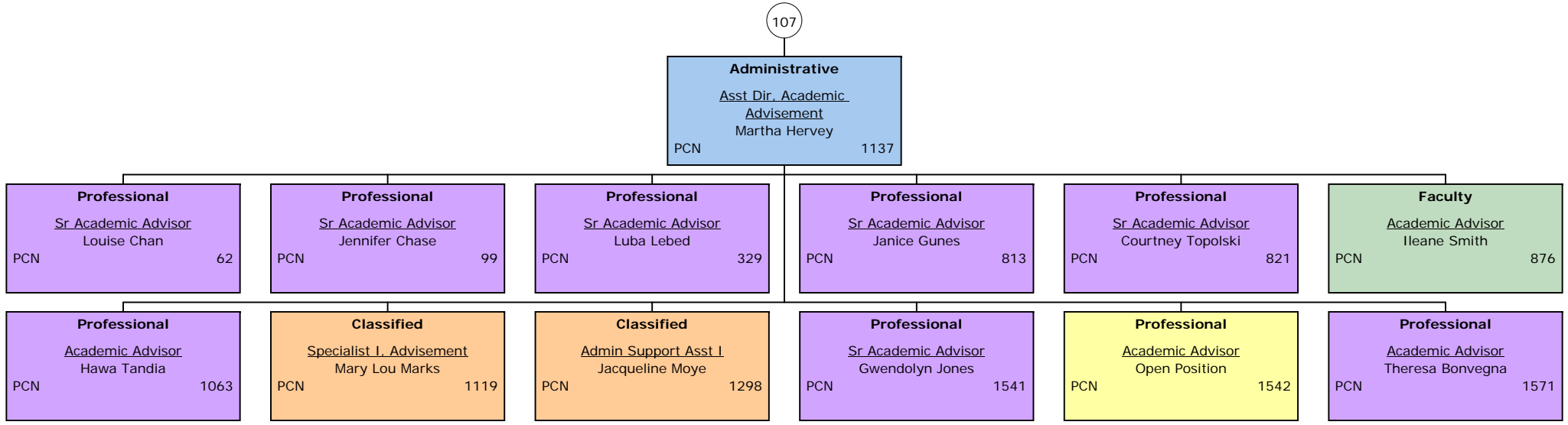

Organizational Chart FY 2017

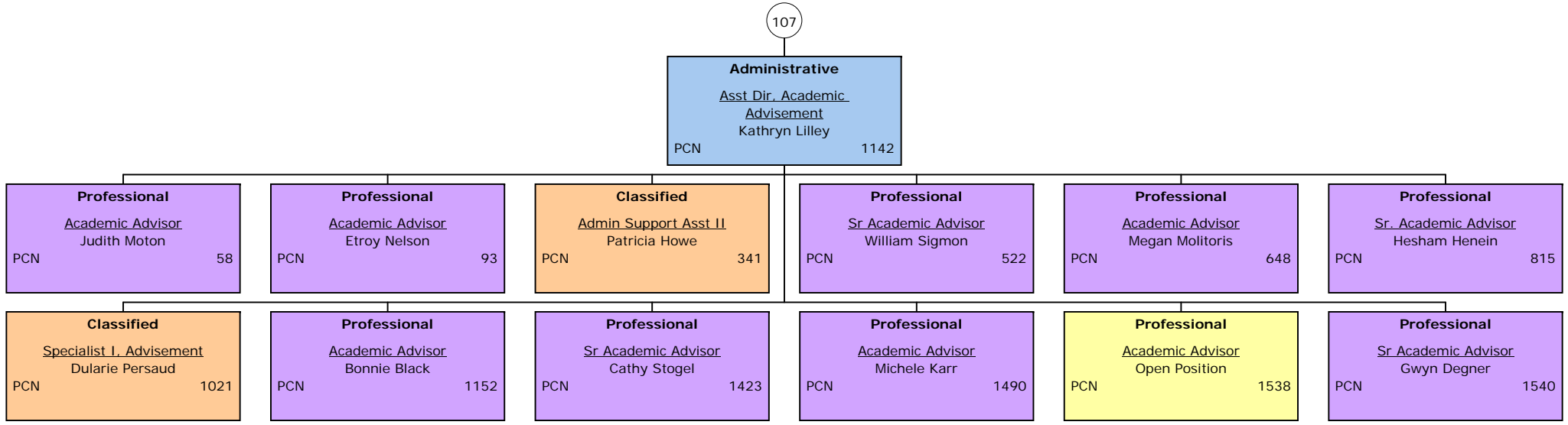

Organizational Chart FY 2017

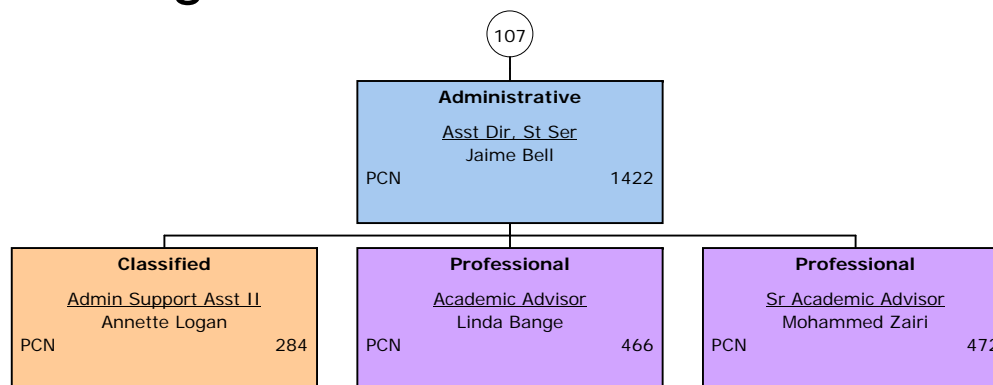

Organizational Chart FY 2017

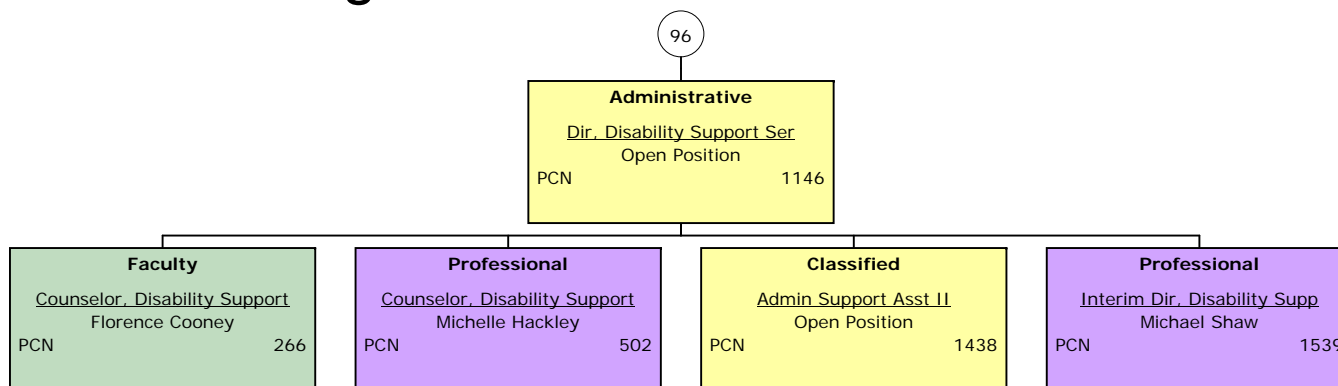

Organizational Chart FY 2017

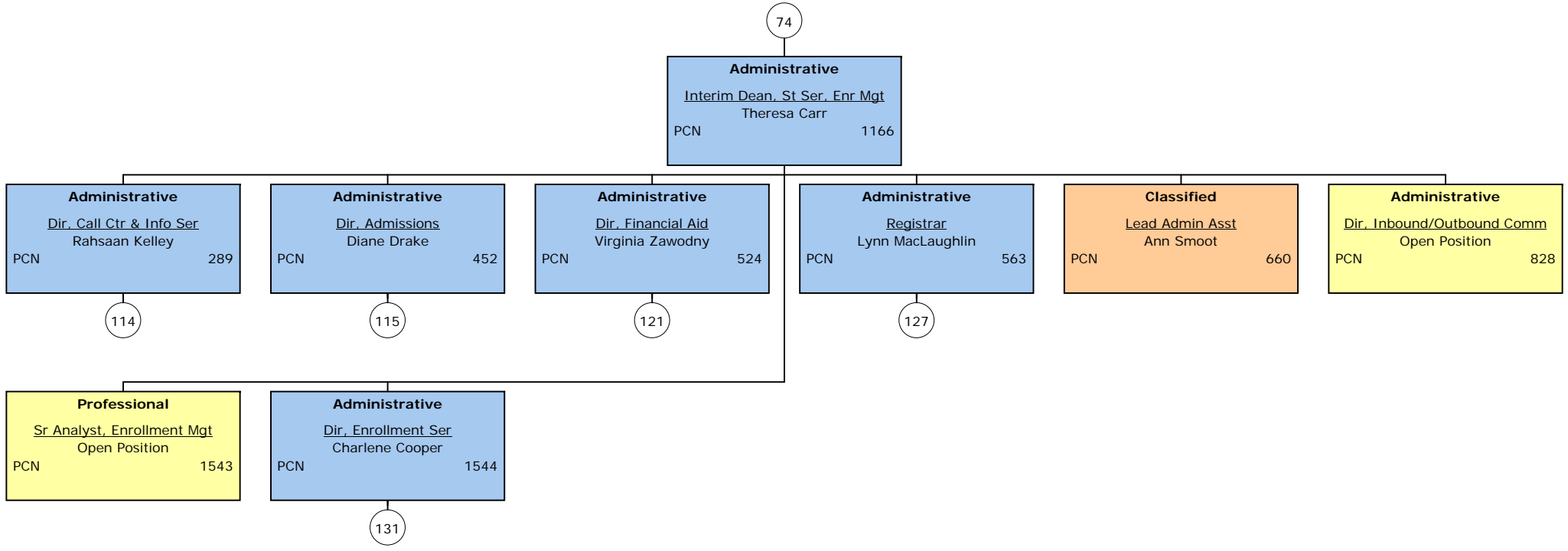

Organizational Chart FY 2017

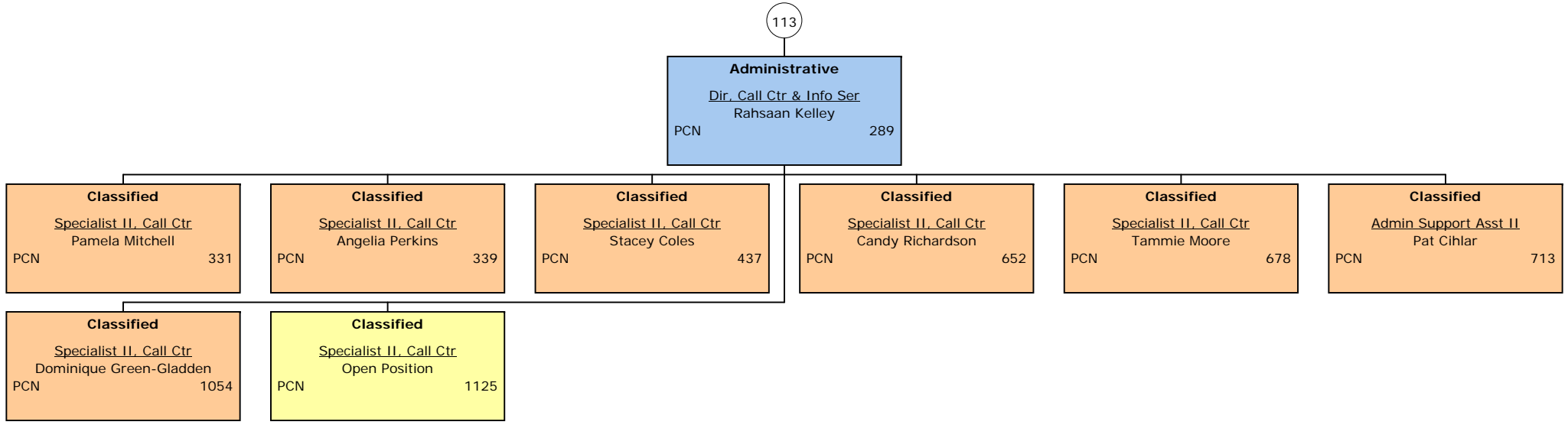

Organizational Chart FY 2017

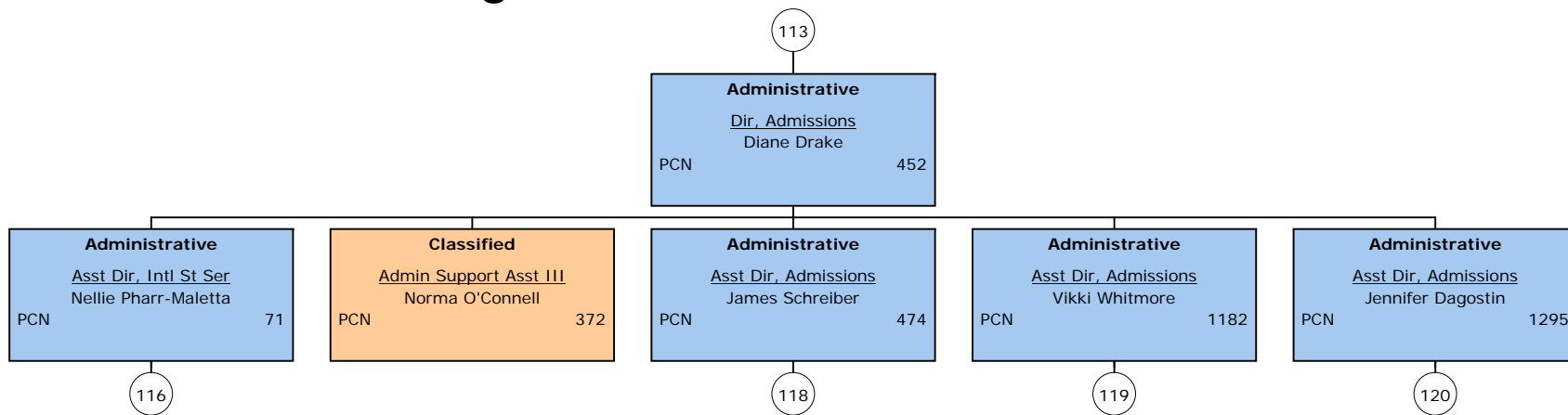

Organizational Chart FY 2017

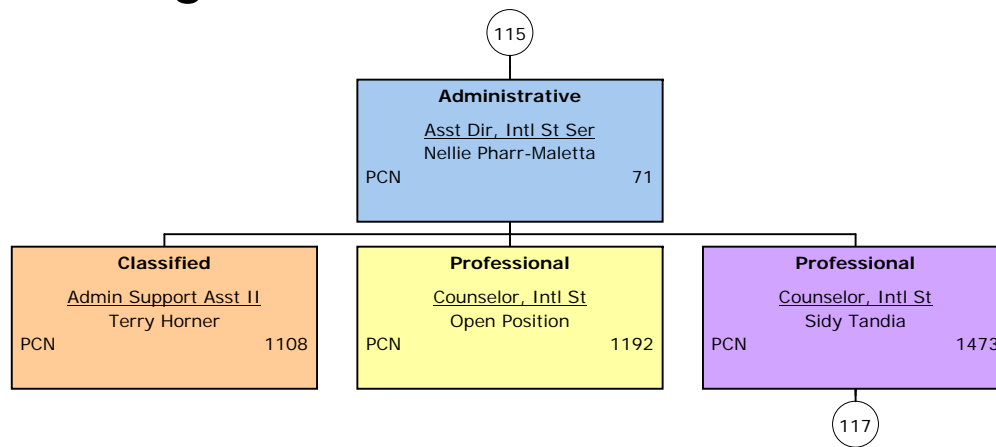

Organizational Chart FY 2017

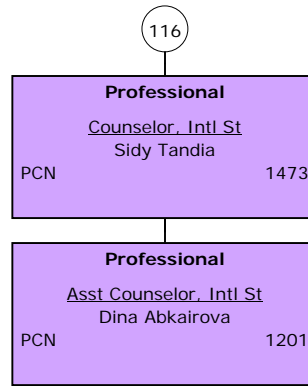

Organizational Chart FY 2017

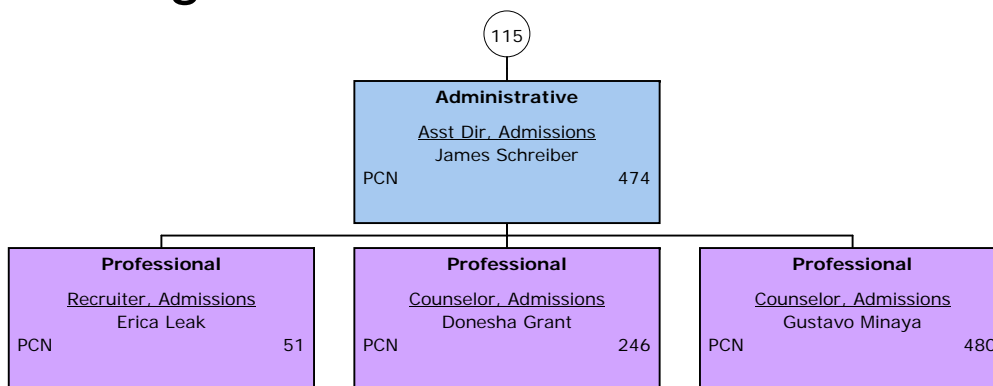

Organizational Chart FY 2017

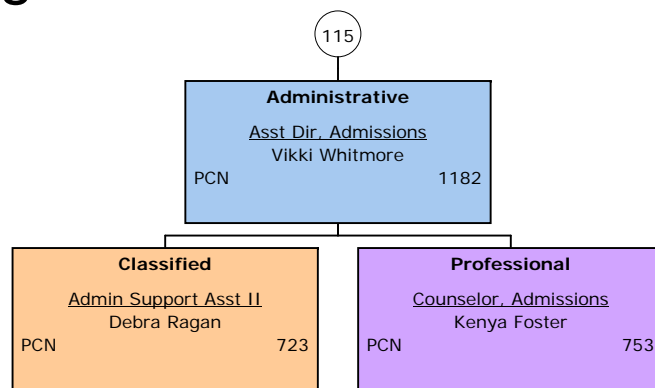

Organizational Chart FY 2017

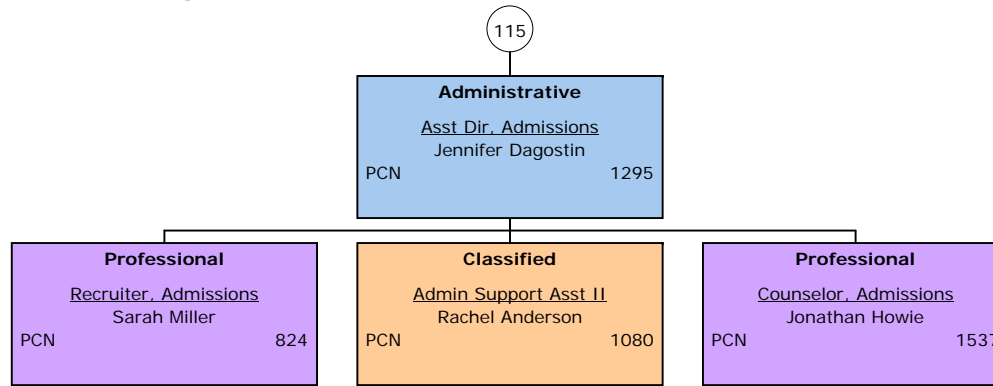

Organizational Chart FY 2017

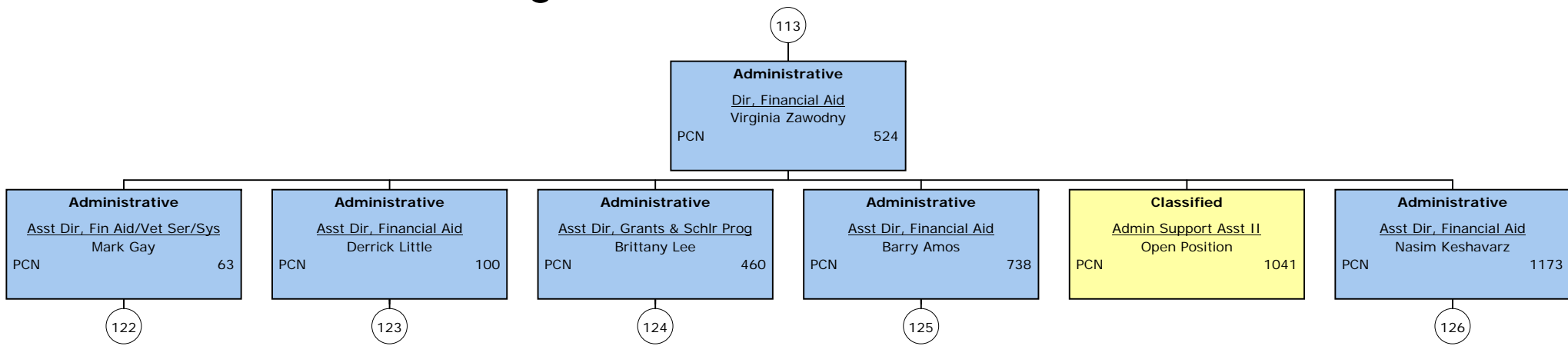

Organizational Chart FY 2017

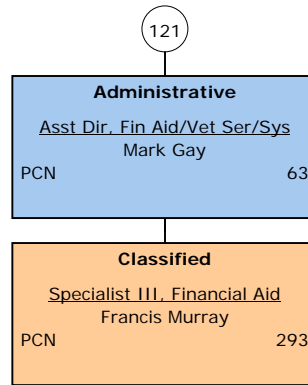

Organizational Chart FY 2017

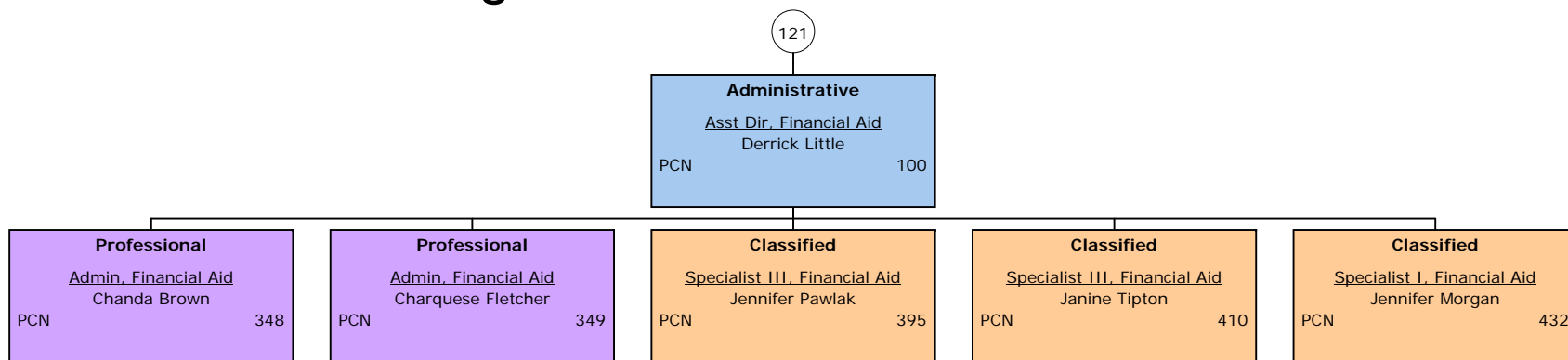

Organizational Chart FY 2017

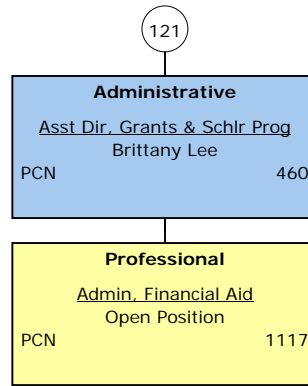

Organizational Chart FY 2017

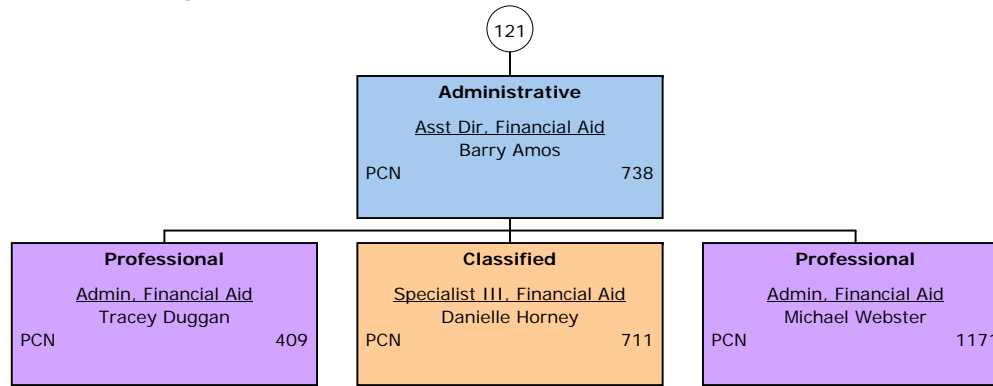

Organizational Chart FY 2017

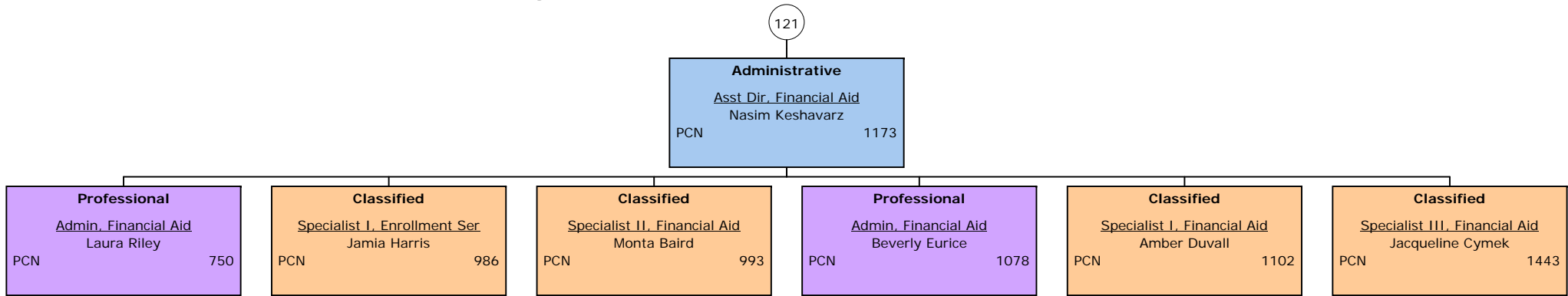

Organizational Chart FY 2017

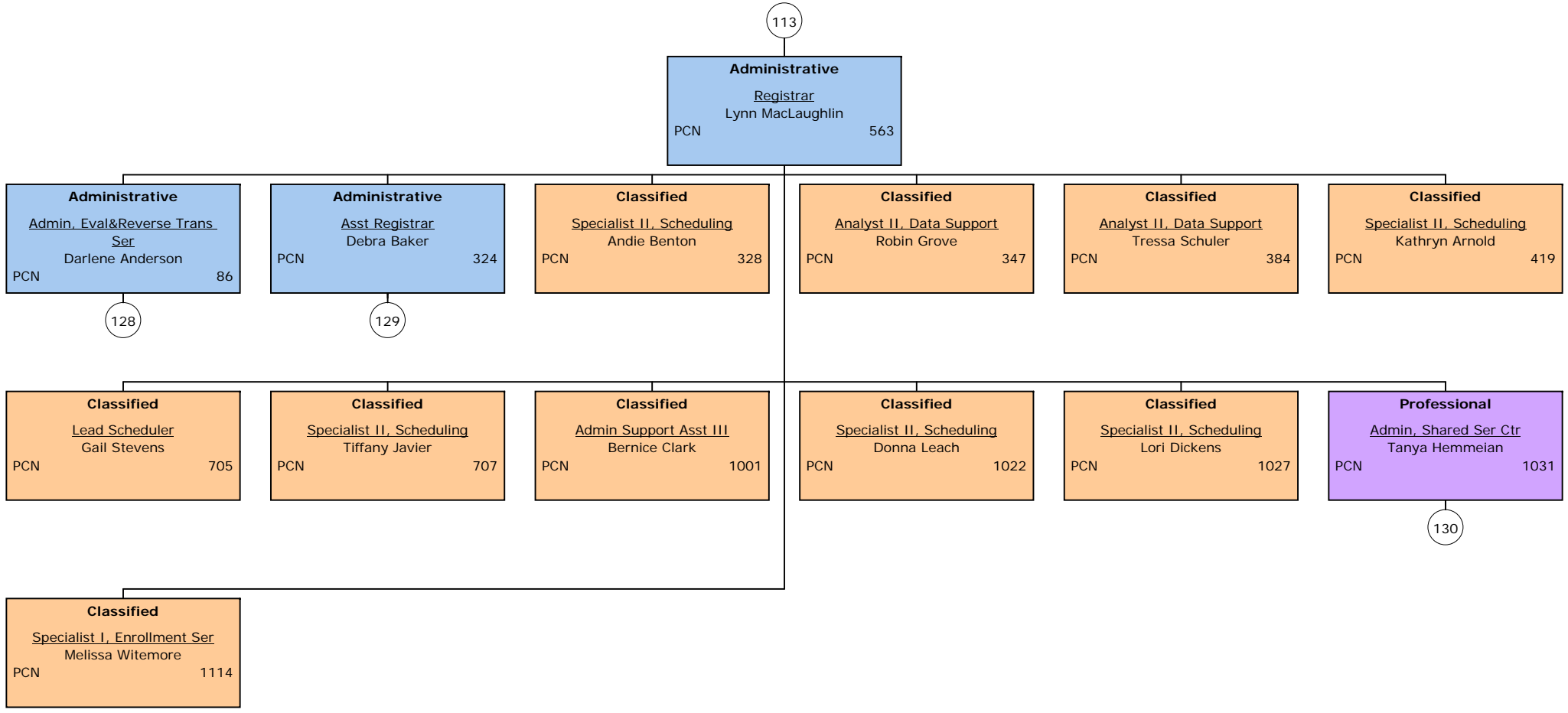

Organizational Chart FY 2017

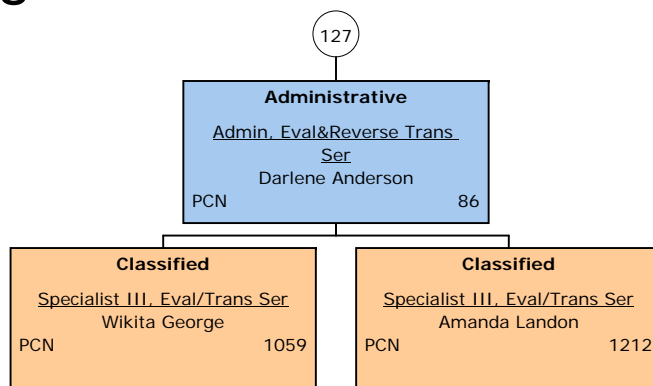

Organizational Chart FY 2017

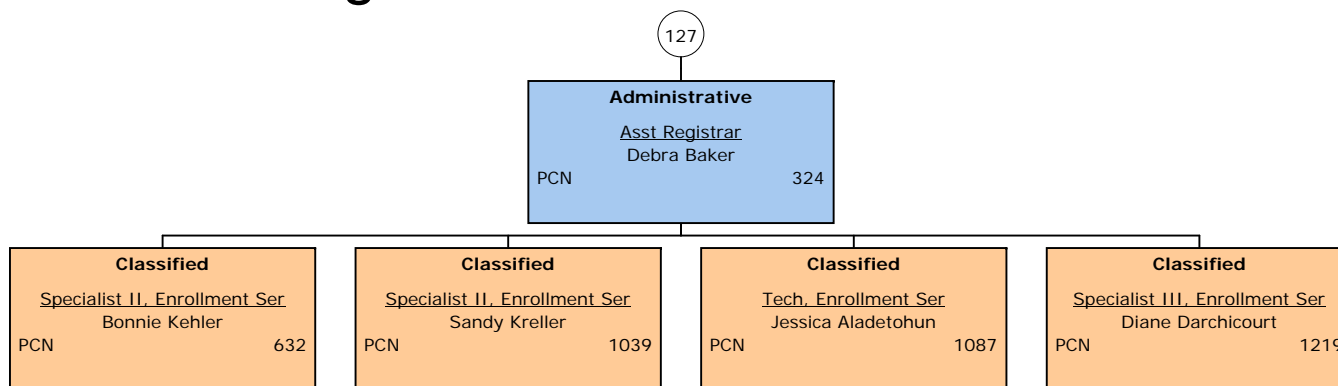

Organizational Chart FY 2017

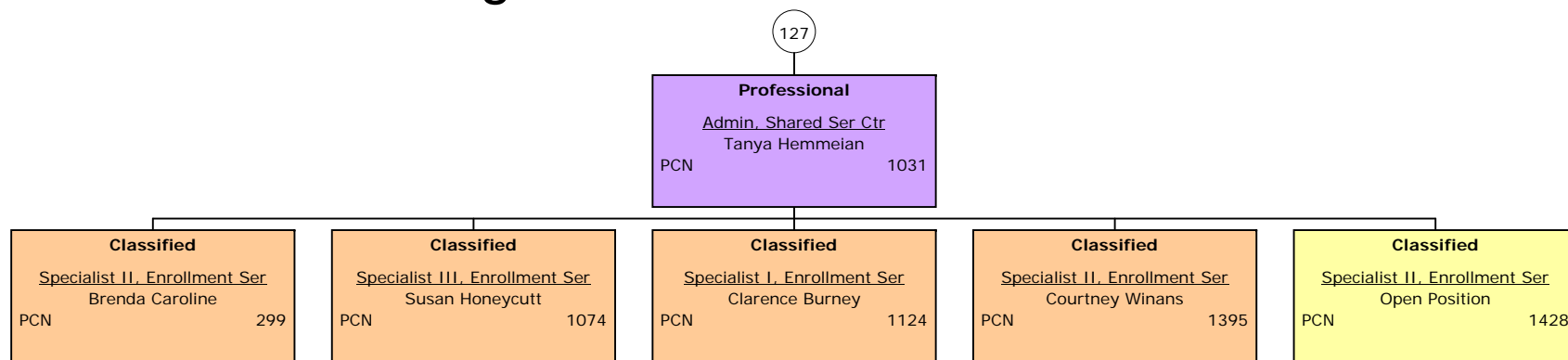

Organizational Chart FY 2017

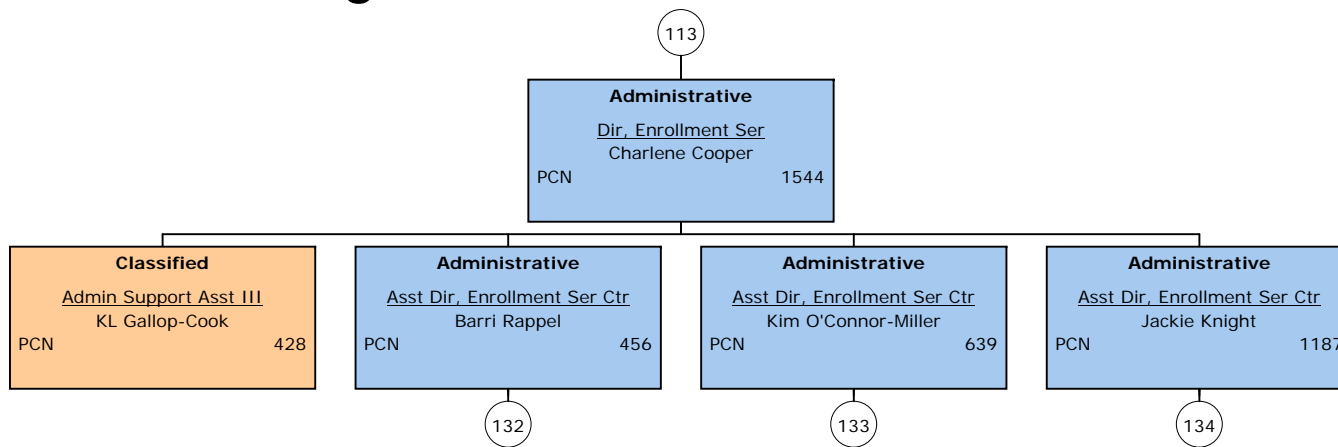

Organizational Chart FY 2017

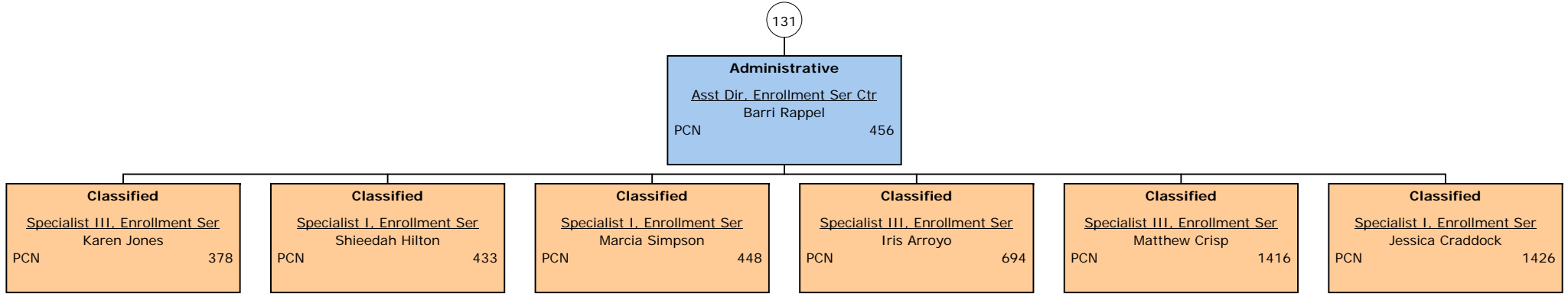

Organizational Chart FY 2017

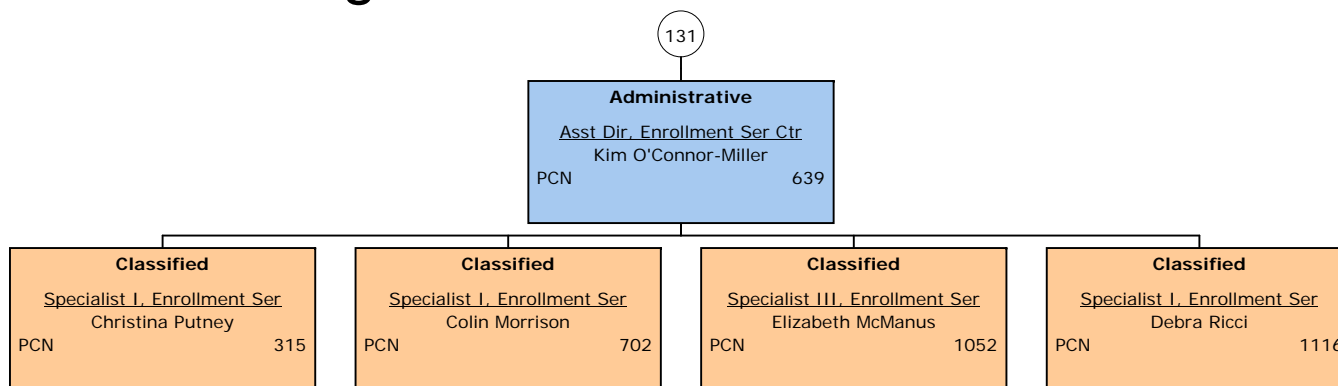

Organizational Chart FY 2017

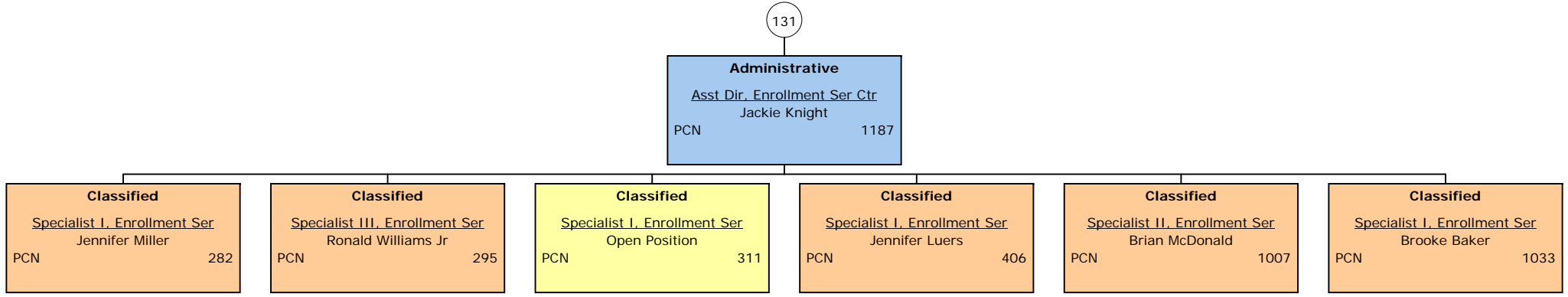

Organizational Chart FY 2017

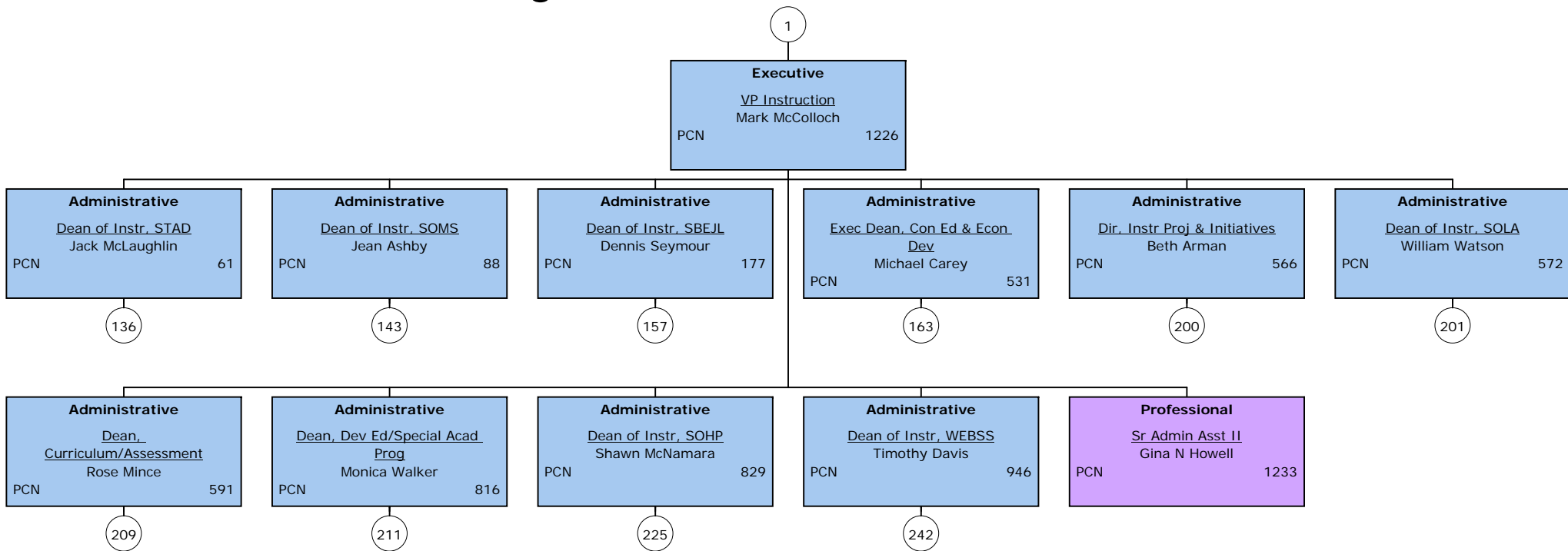

Organizational Chart FY 2017

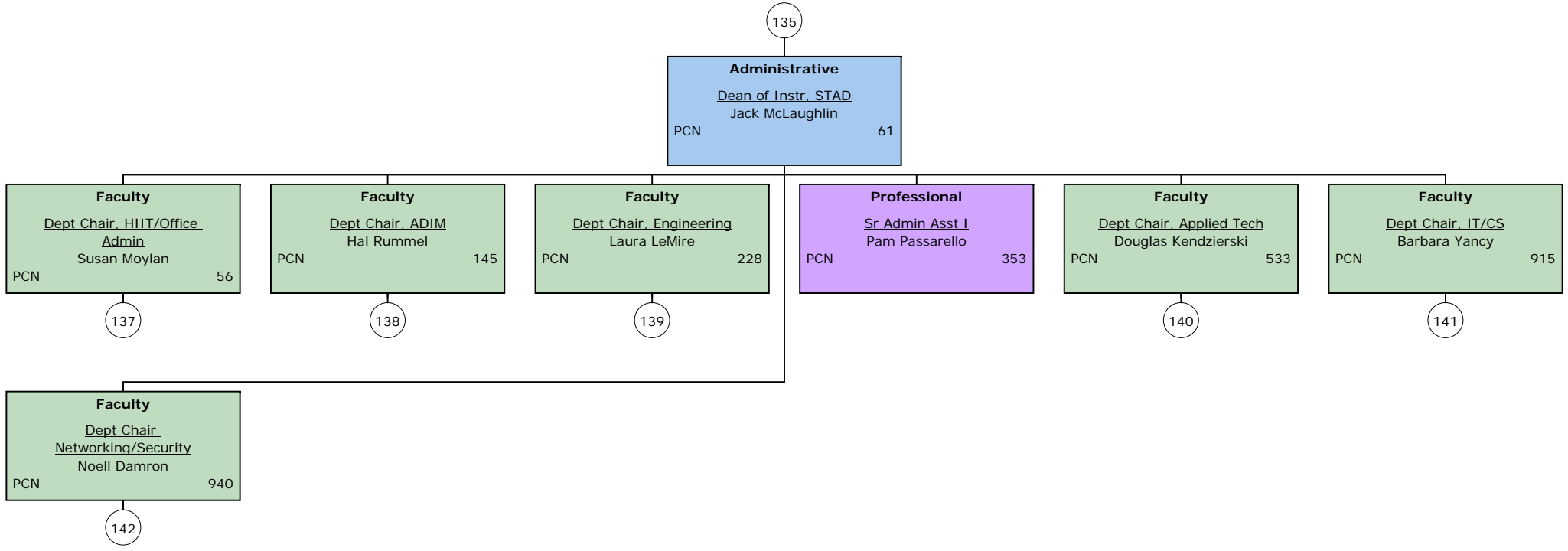

Organizational Chart FY 2017

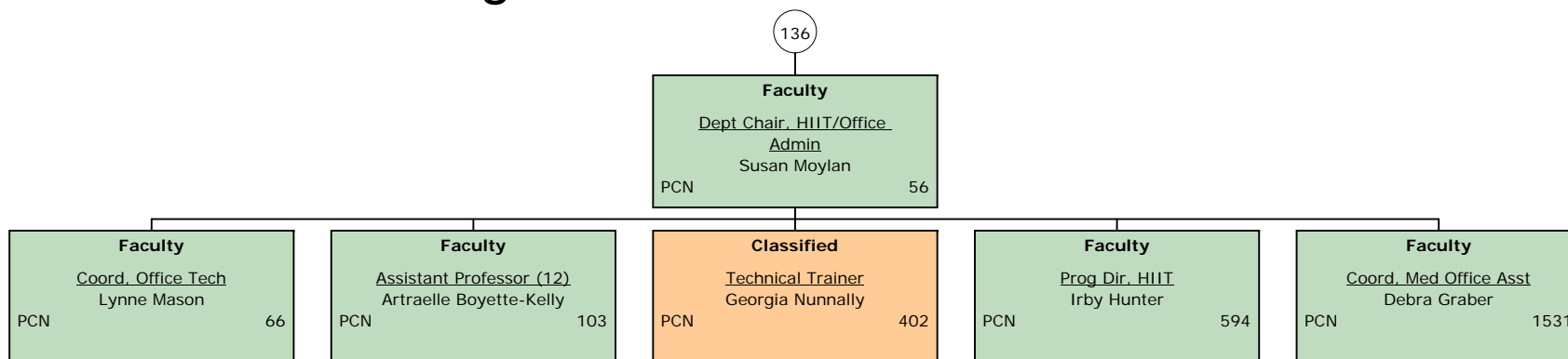

Organizational Chart FY 2017

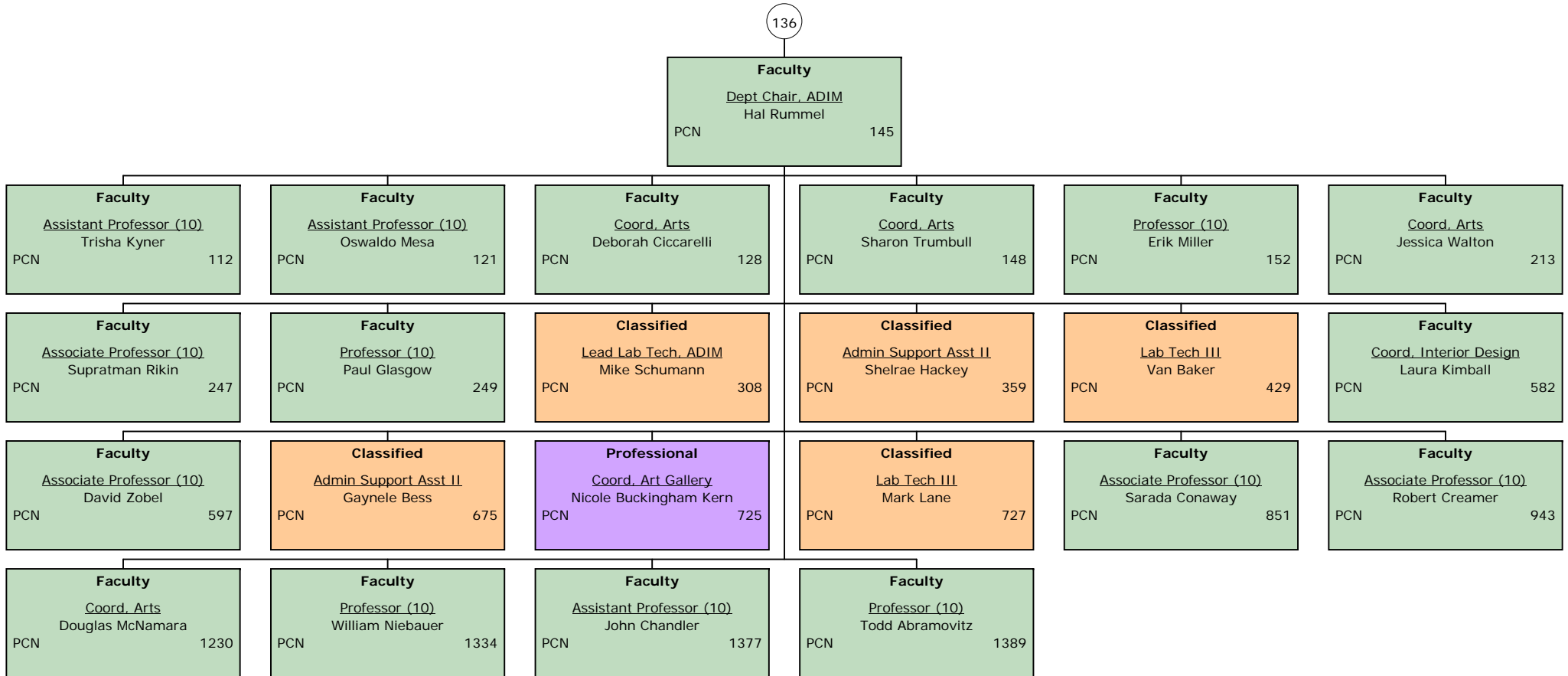

Organizational Chart FY 2017

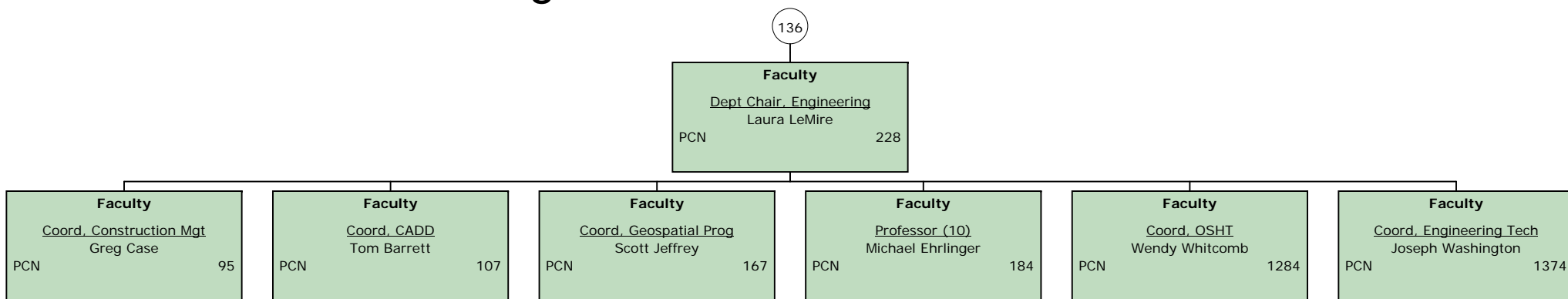

Organizational Chart FY 2017

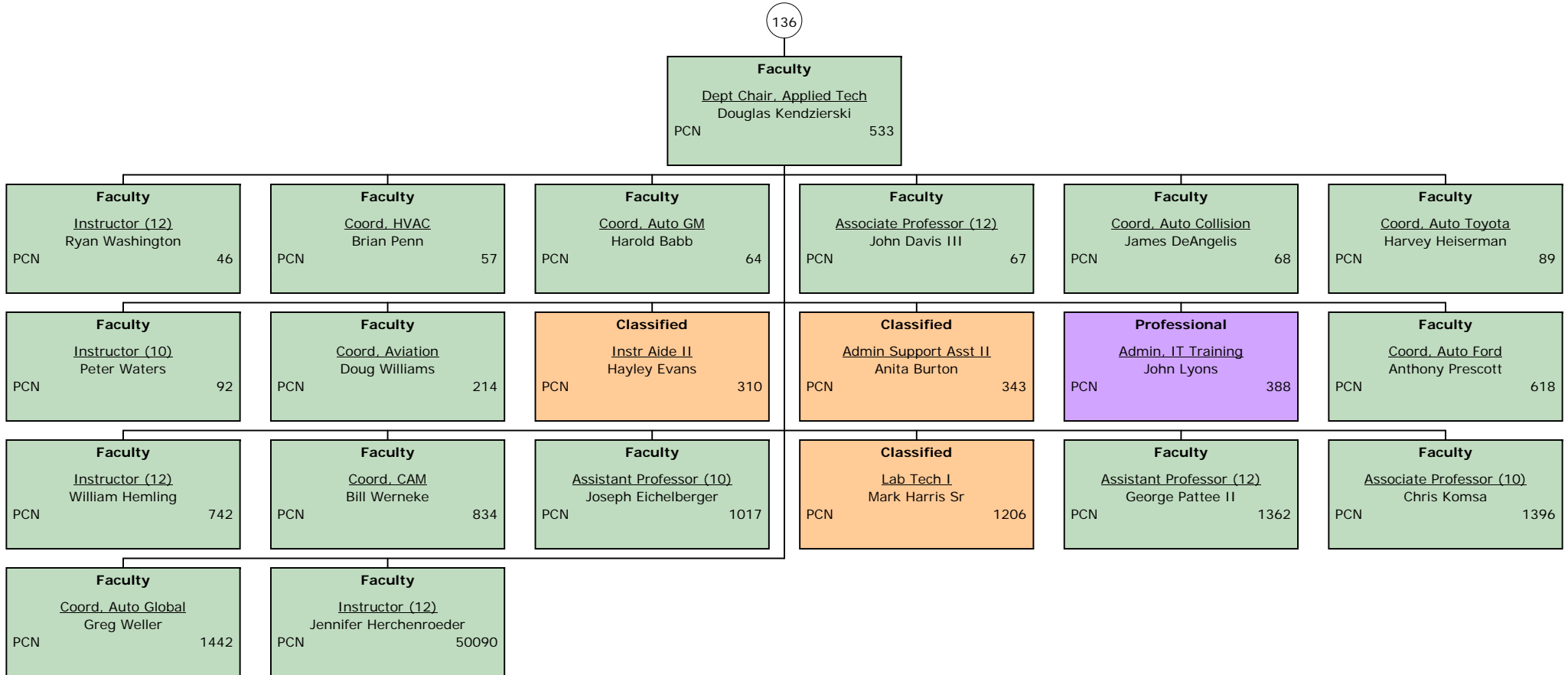

Organizational Chart FY 2017

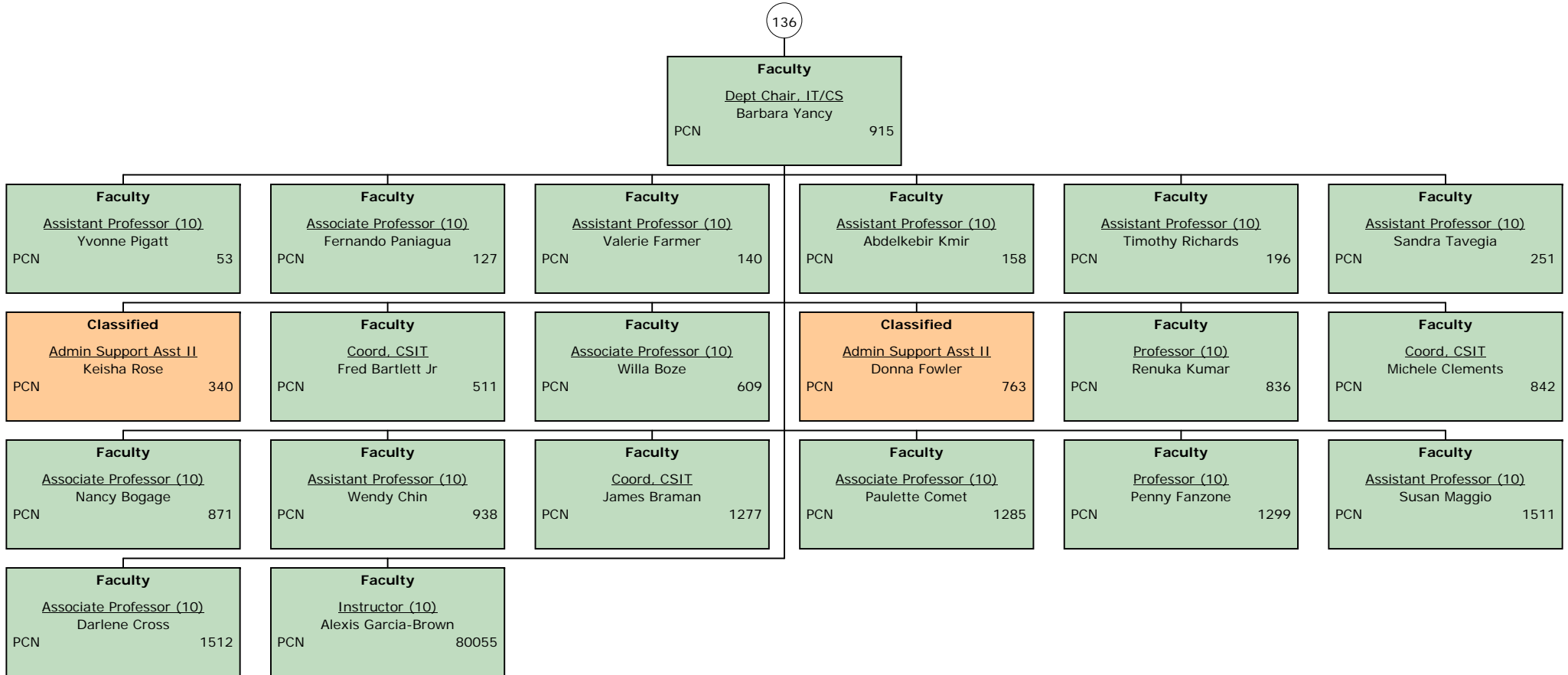

Organizational Chart FY 2017

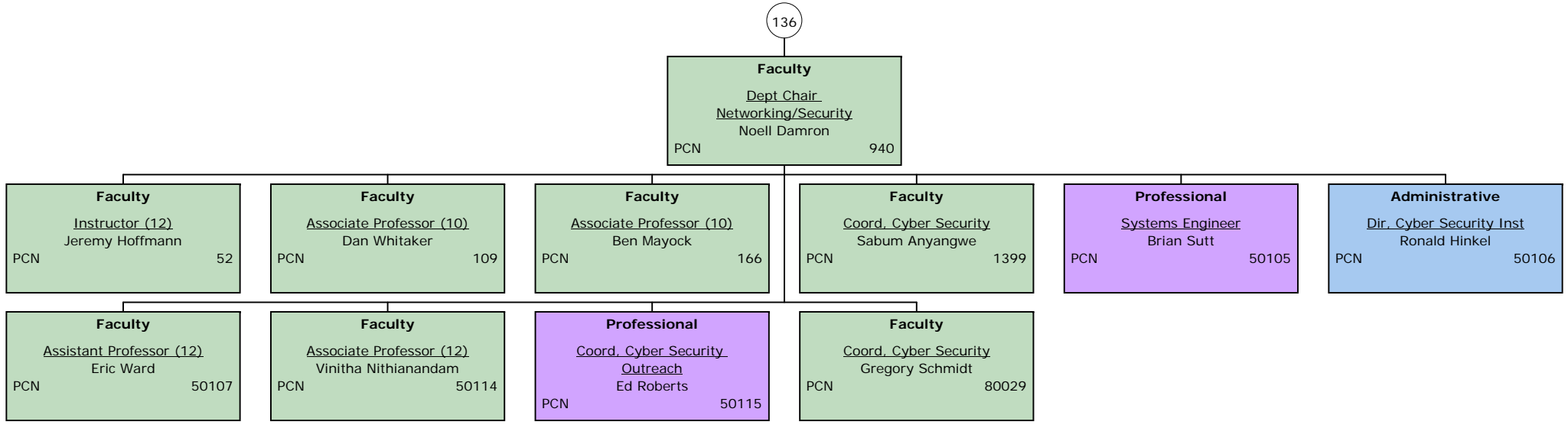

Organizational Chart FY 2017

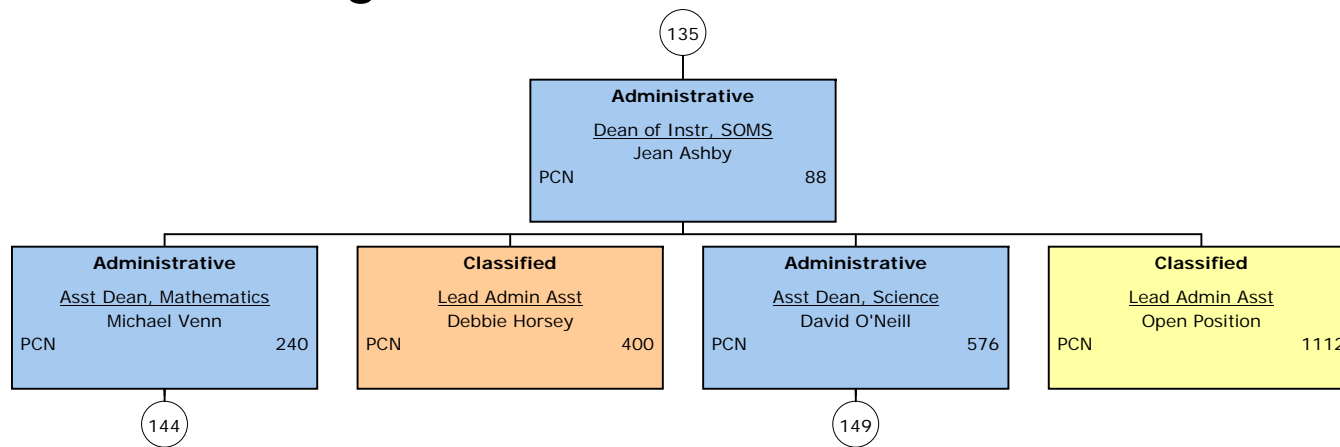

Organizational Chart FY 2017

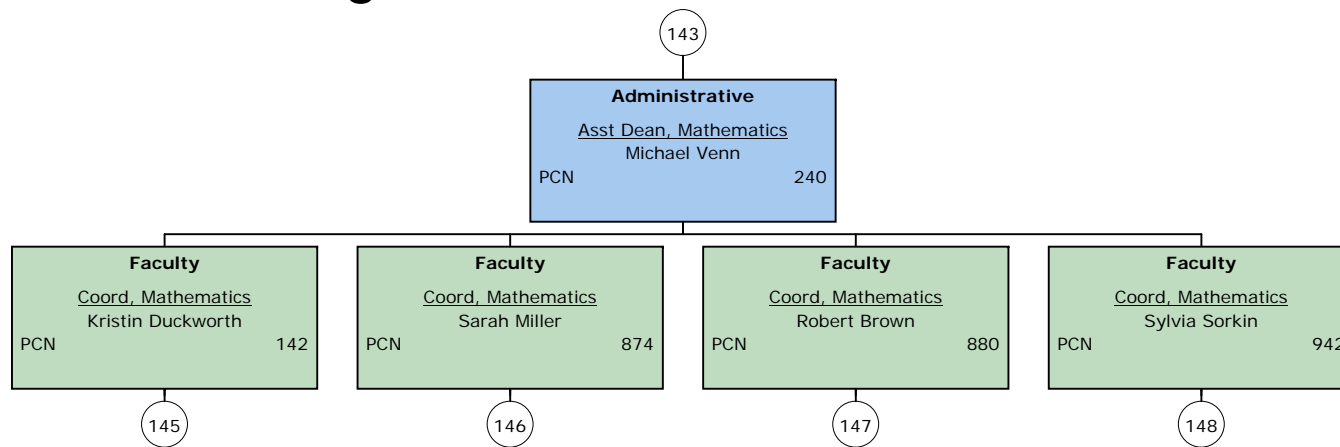

Organizational Chart FY 2017

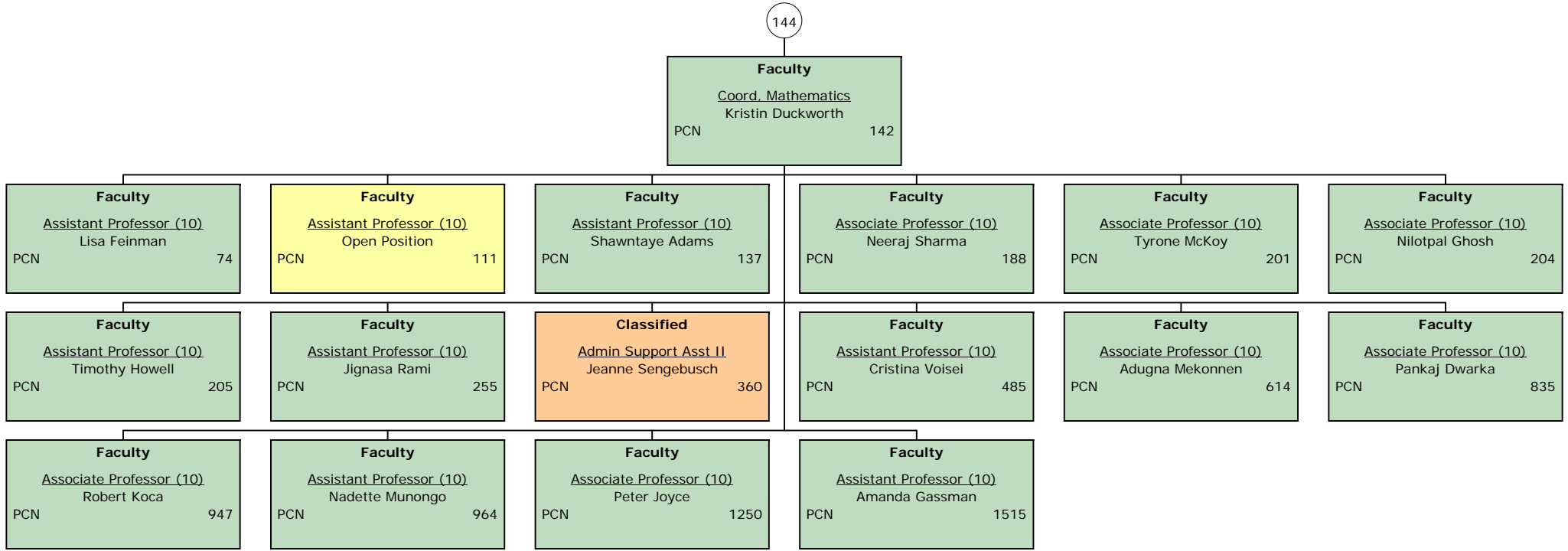

Organizational Chart FY 2017

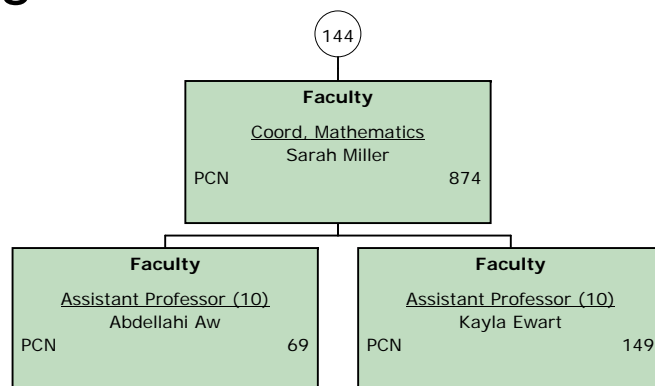

Organizational Chart FY 2017

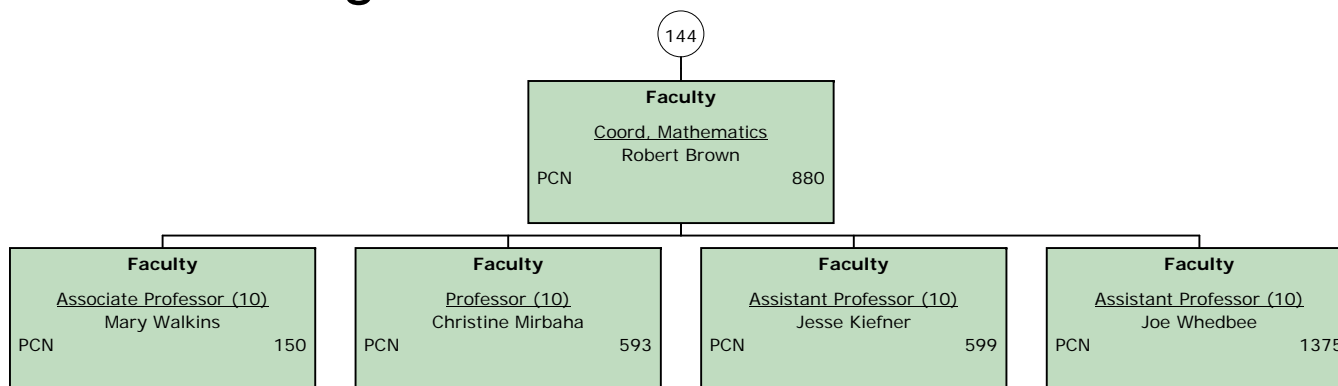

Organizational Chart FY 2017

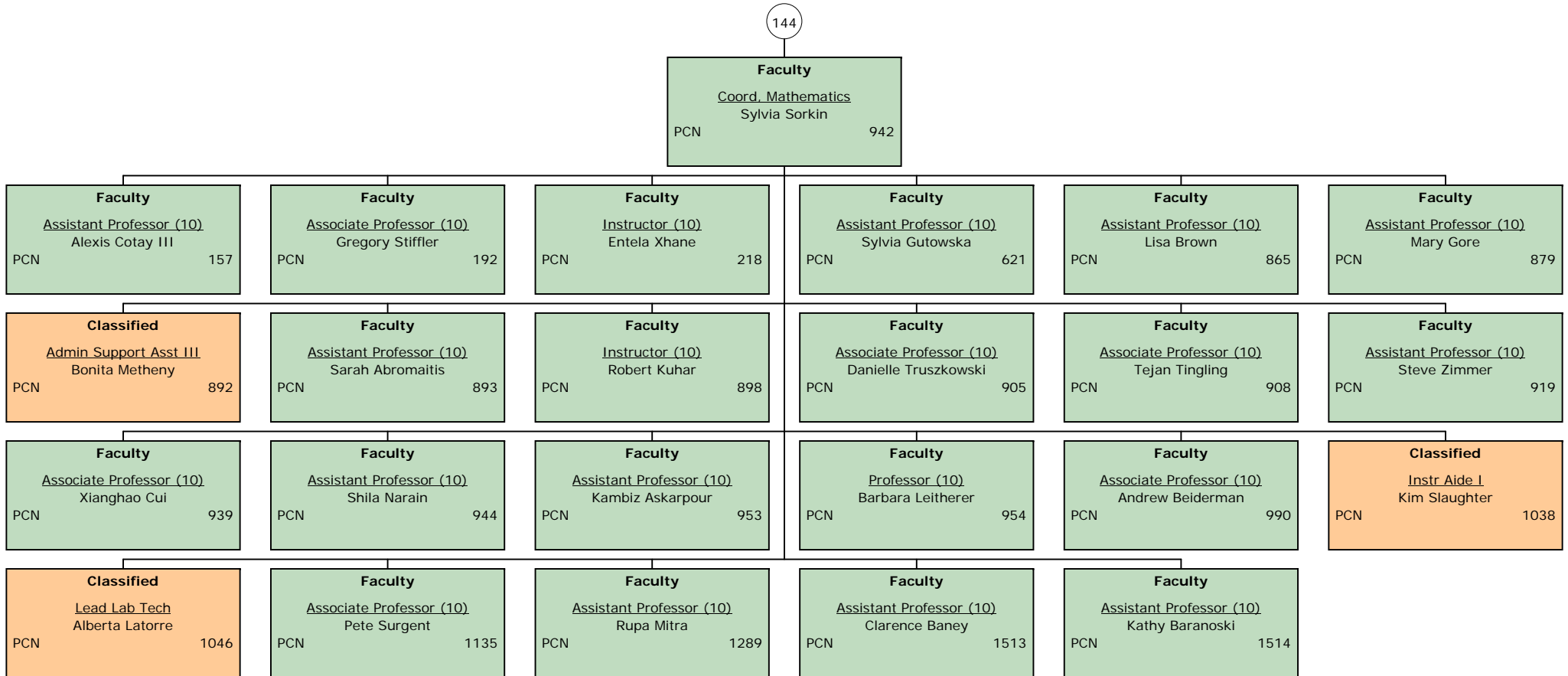

Organizational Chart FY 2017

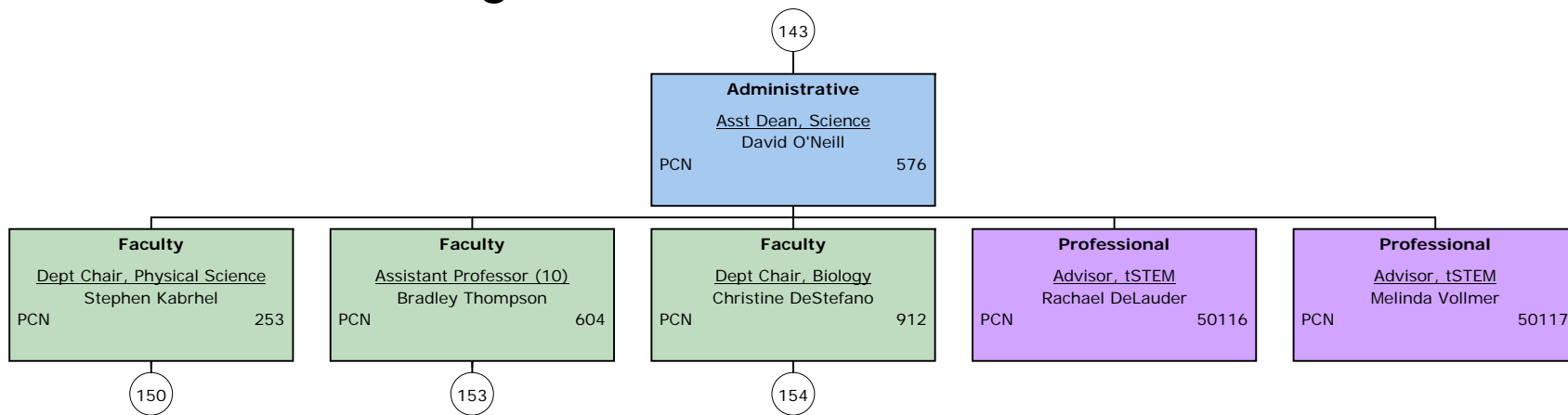

Organizational Chart FY 2017

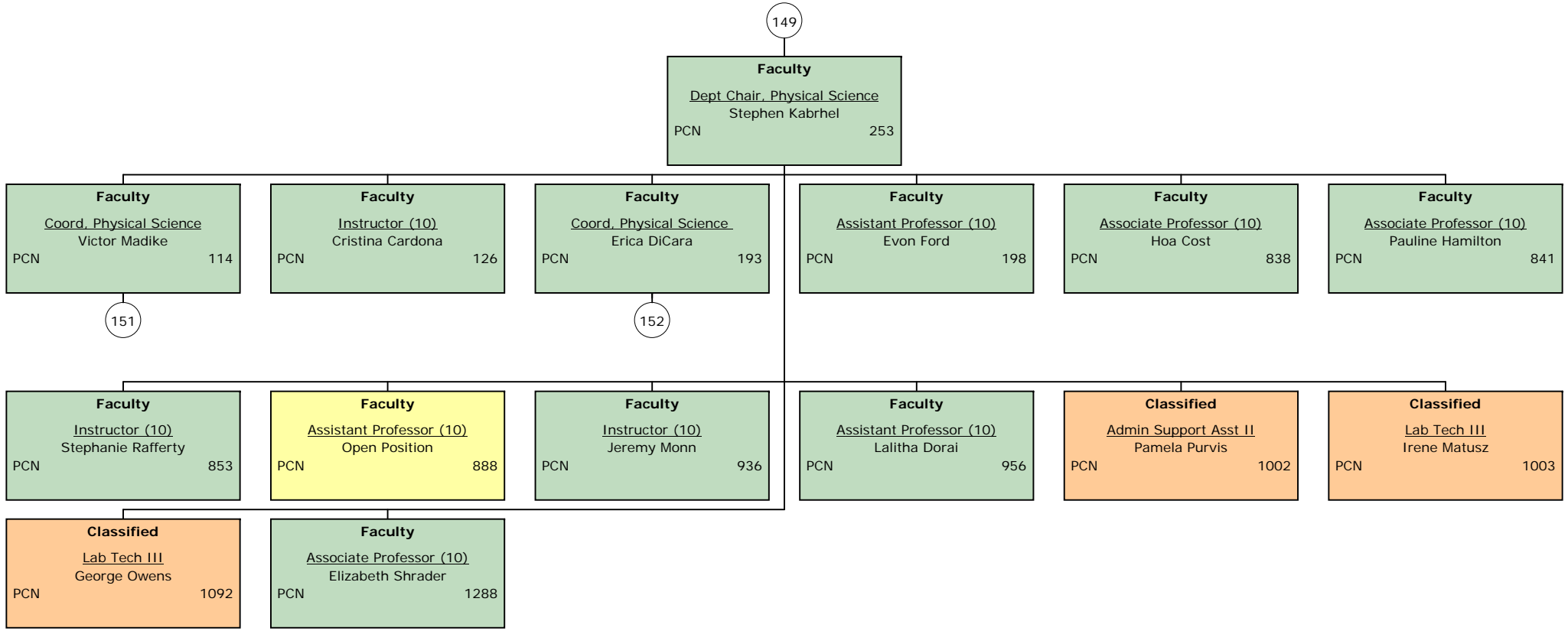

Organizational Chart FY 2017

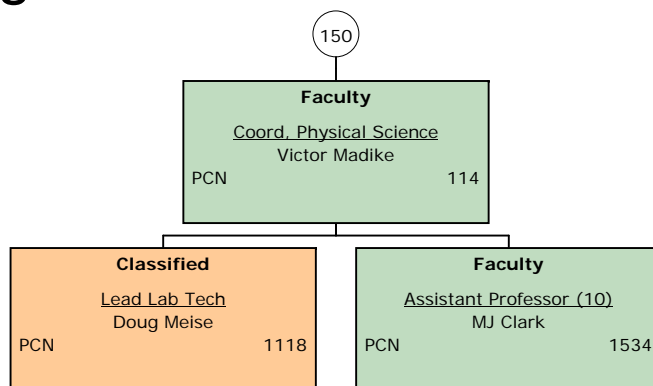

Organizational Chart FY 2017

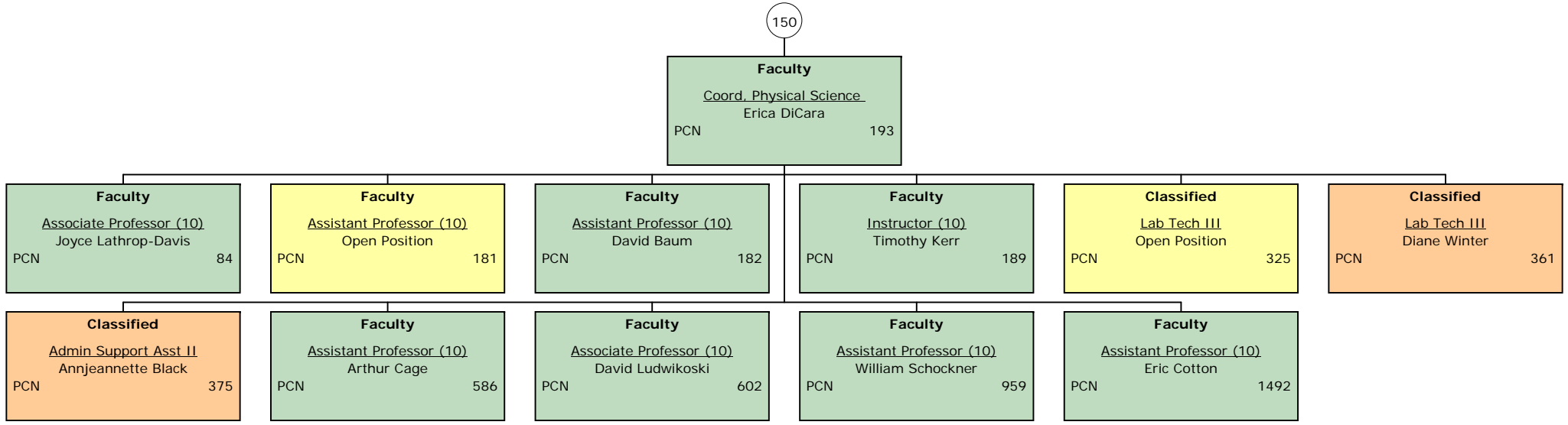

Organizational Chart FY 2017

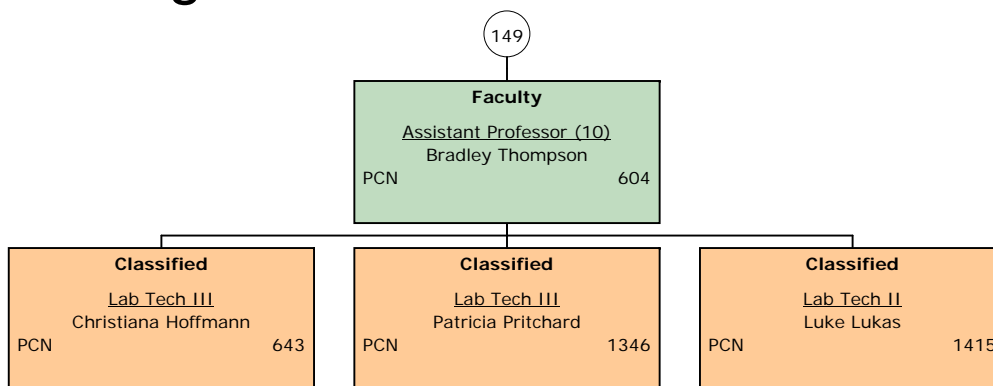

Organizational Chart FY 2017

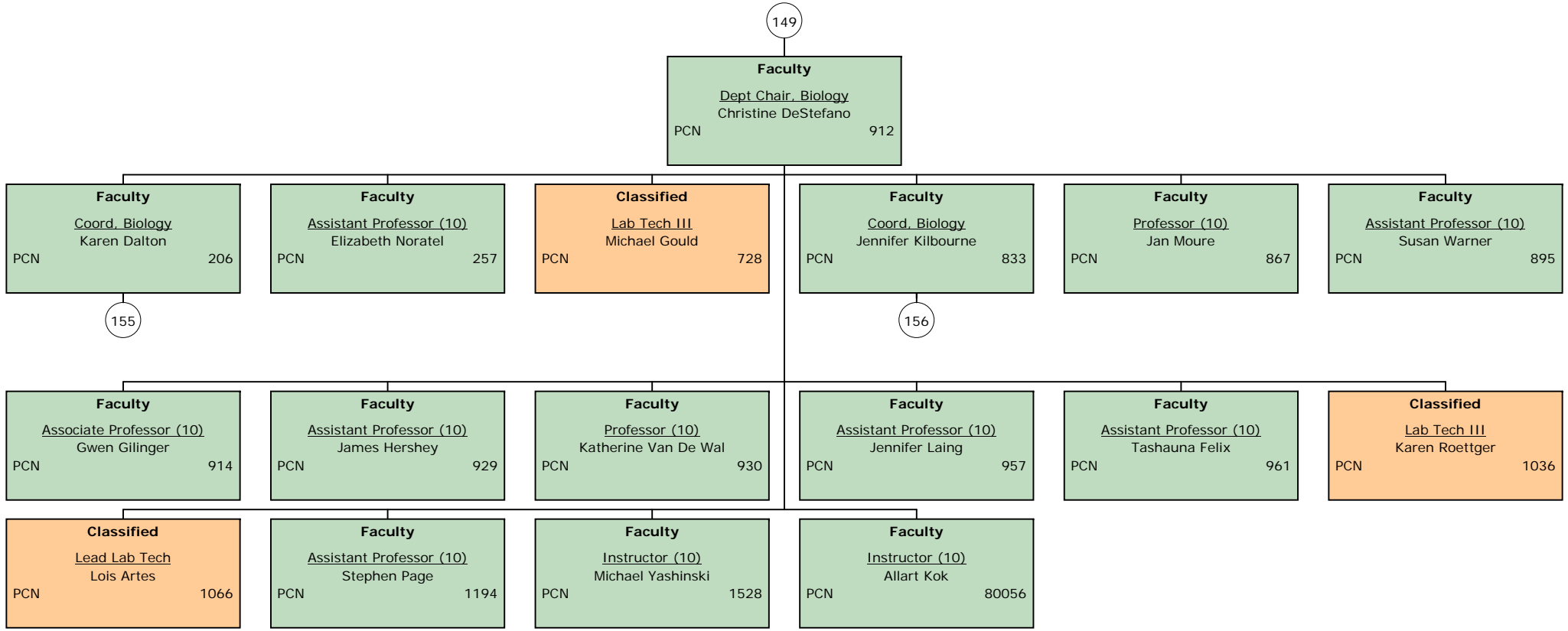

Organizational Chart FY 2017

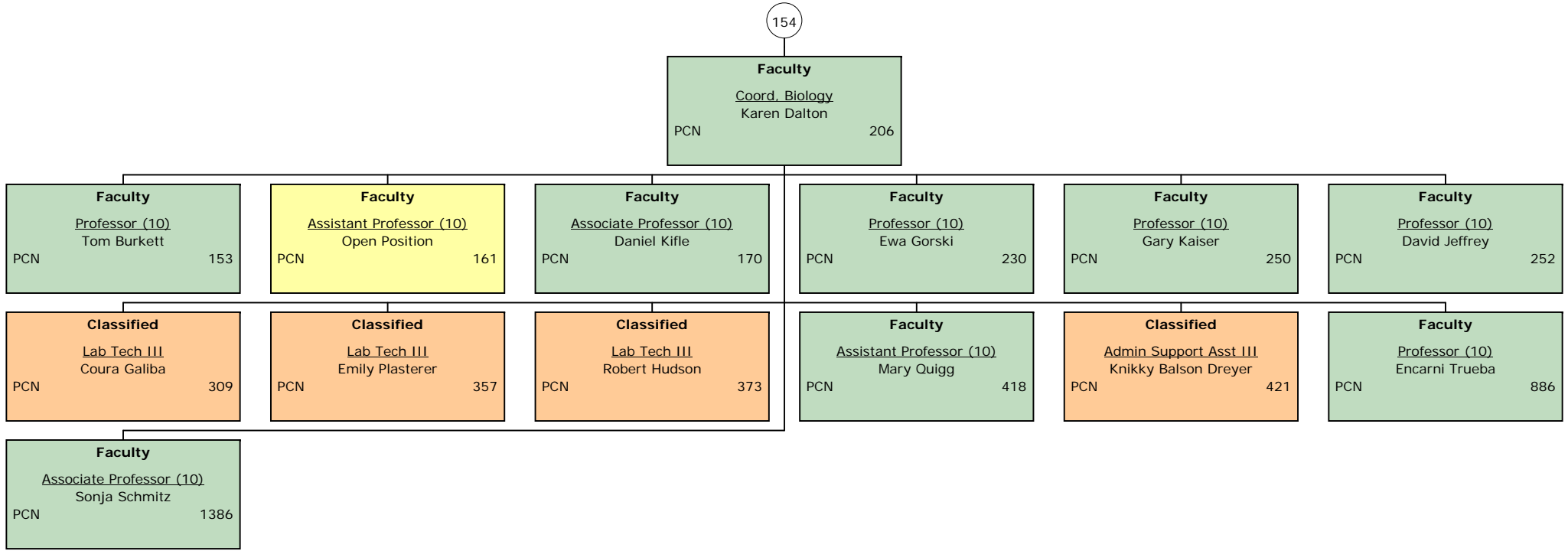

Organizational Chart FY 2017

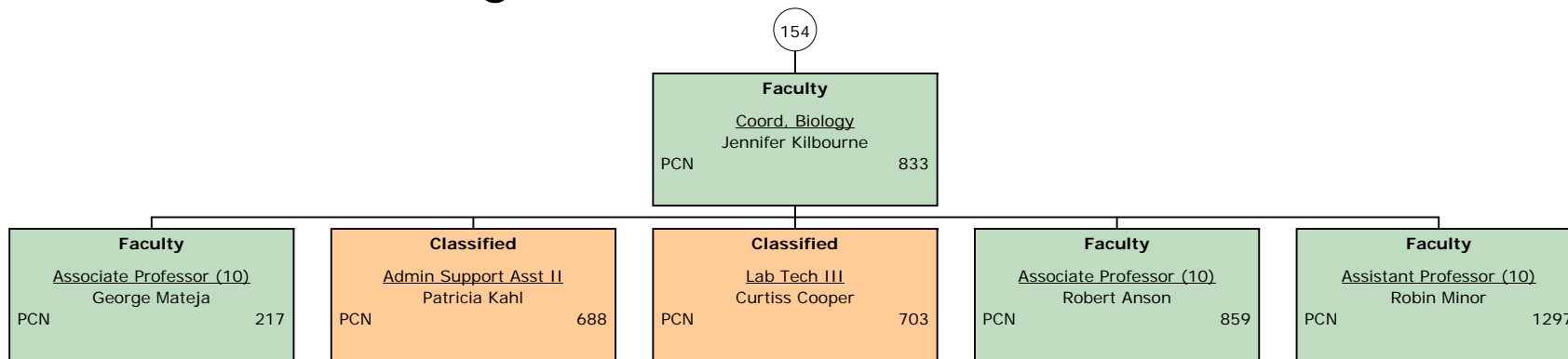

Organizational Chart FY 2017

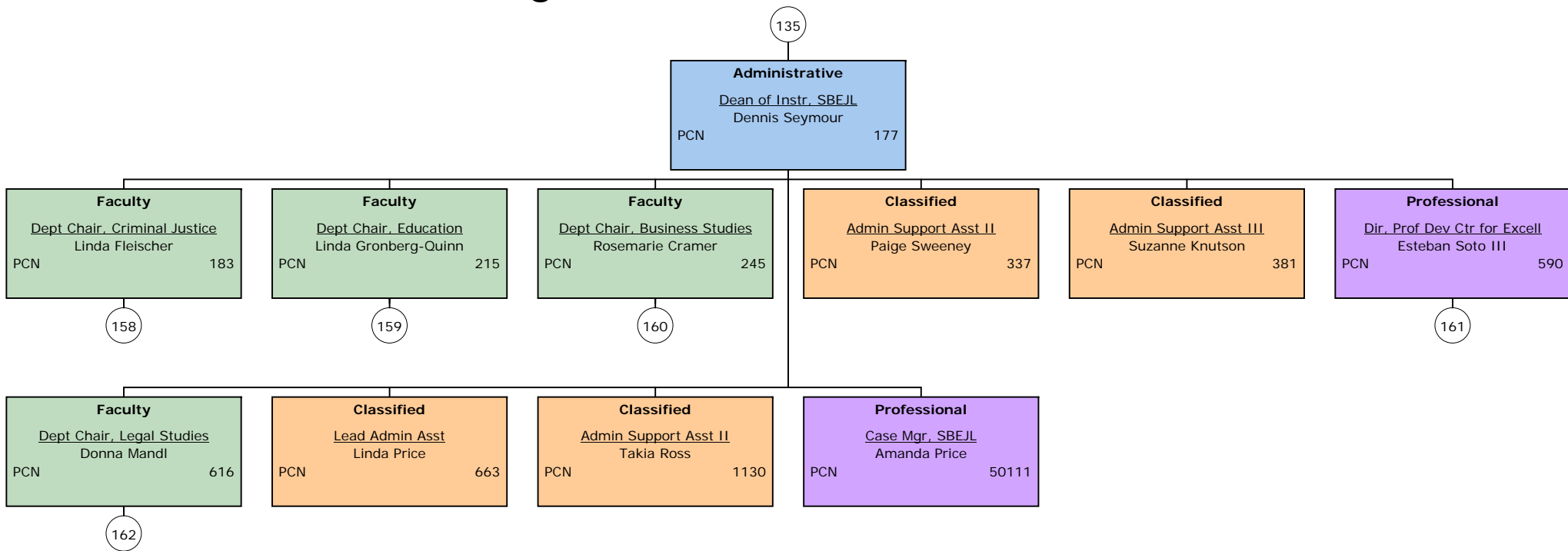

Organizational Chart FY 2017

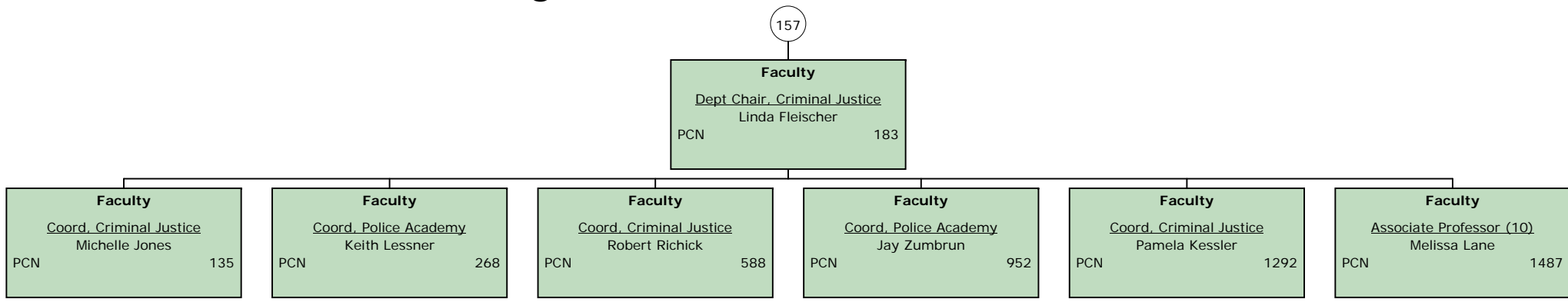

Organizational Chart FY 2017

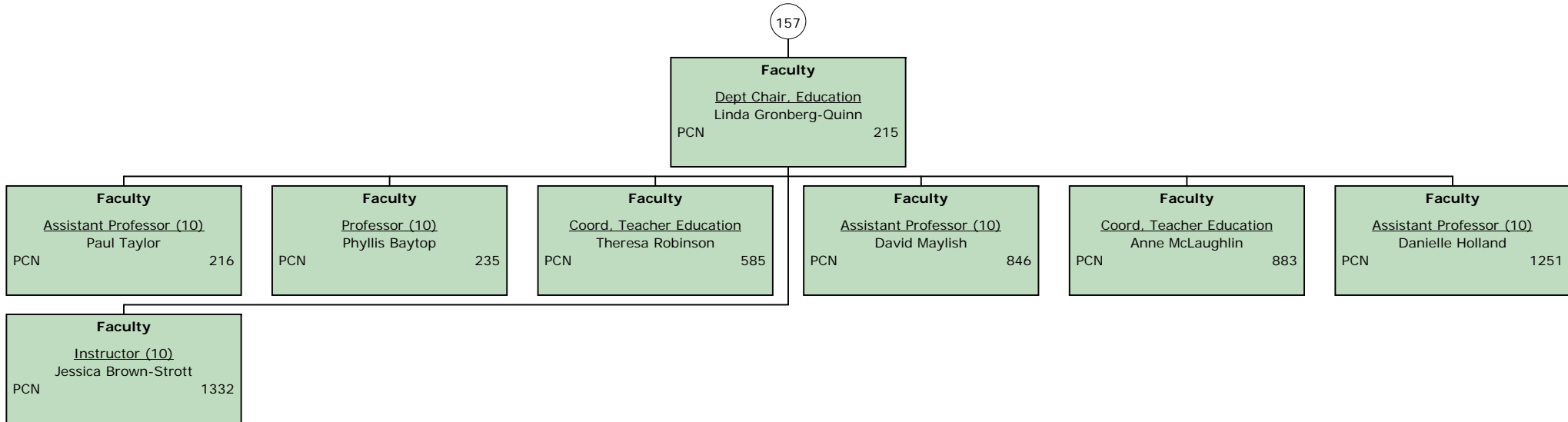

Organizational Chart FY 2017

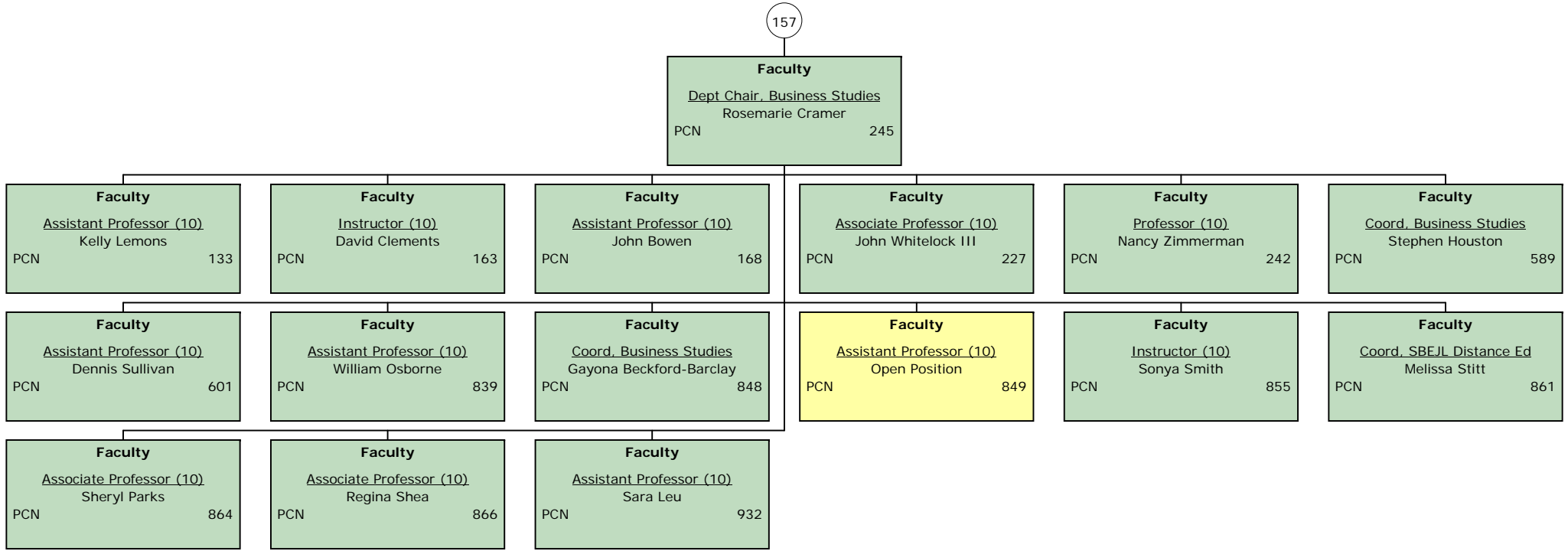

Organizational Chart FY 2017

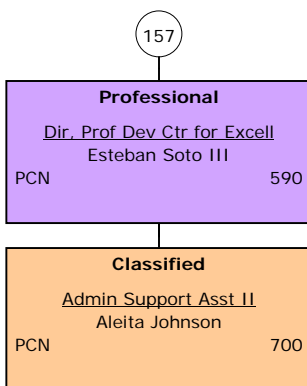

Organizational Chart FY 2017

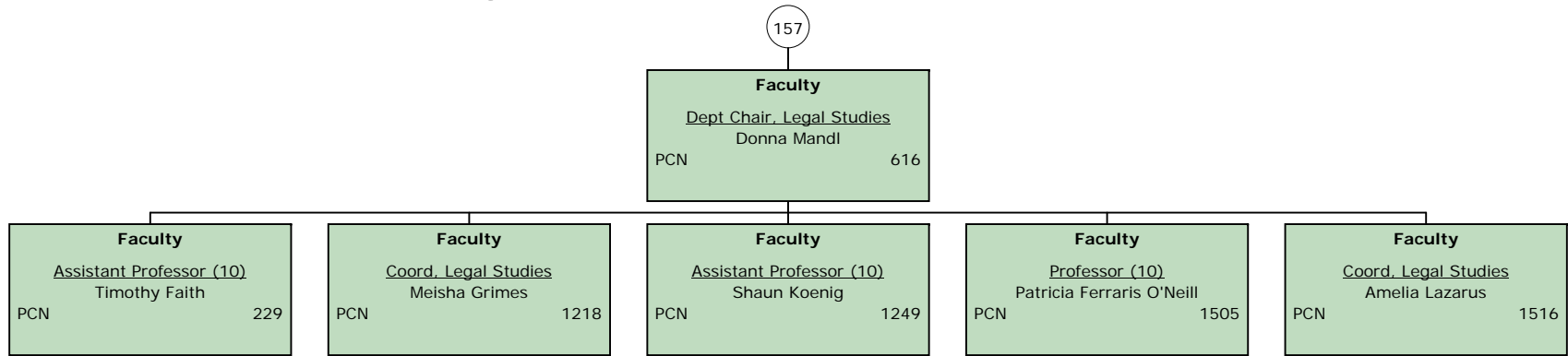

Organizational Chart FY 2017

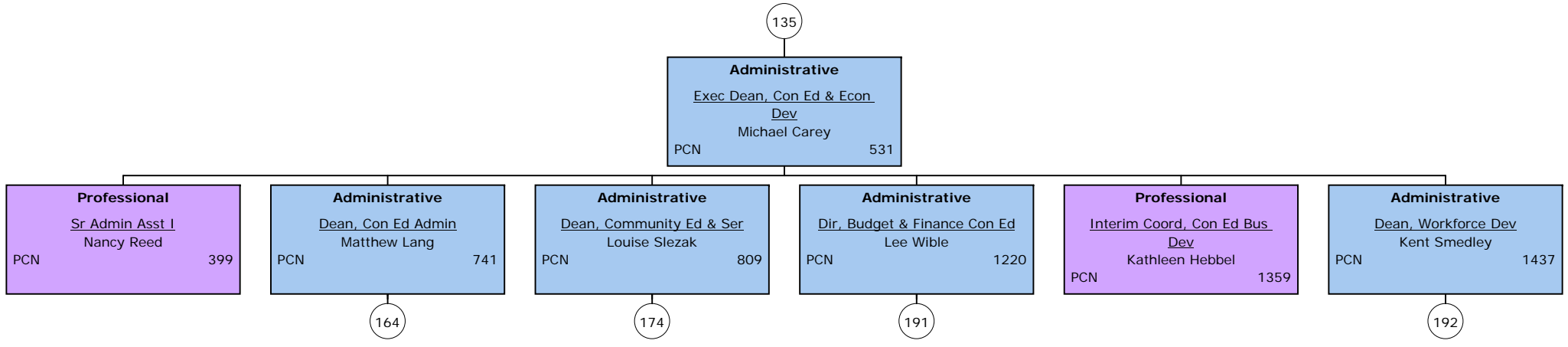

Organizational Chart FY 2017

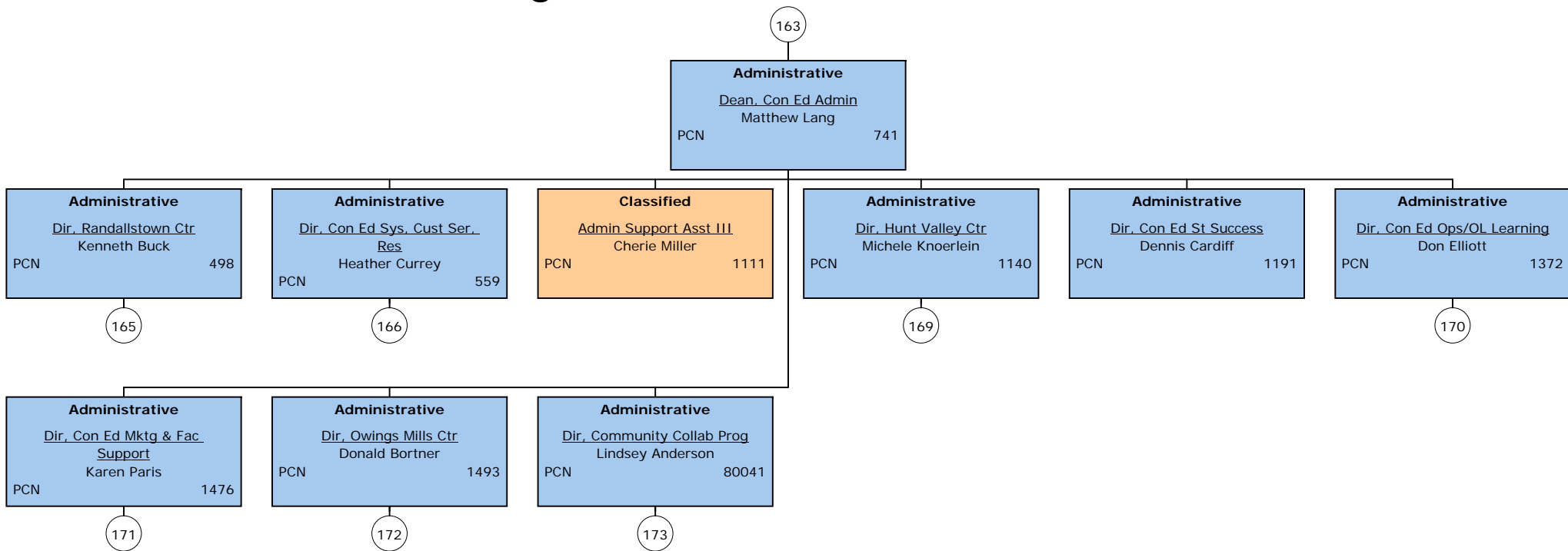

Organizational Chart FY 2017

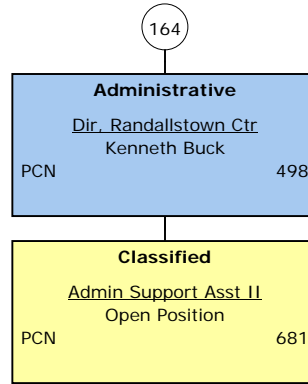

Organizational Chart FY 2017

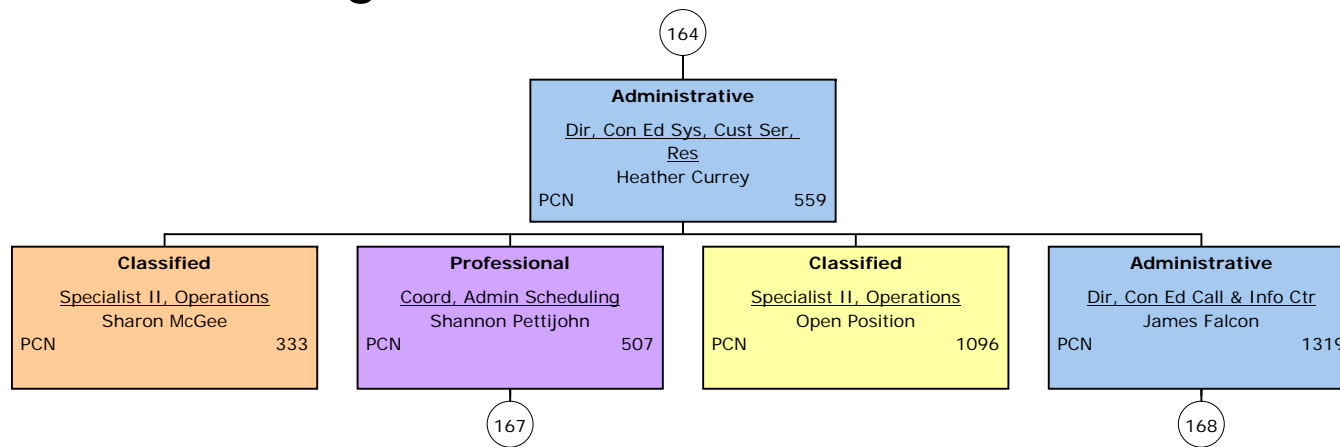

Organizational Chart FY 2017

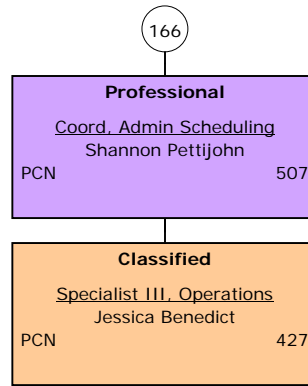

Organizational Chart FY 2017

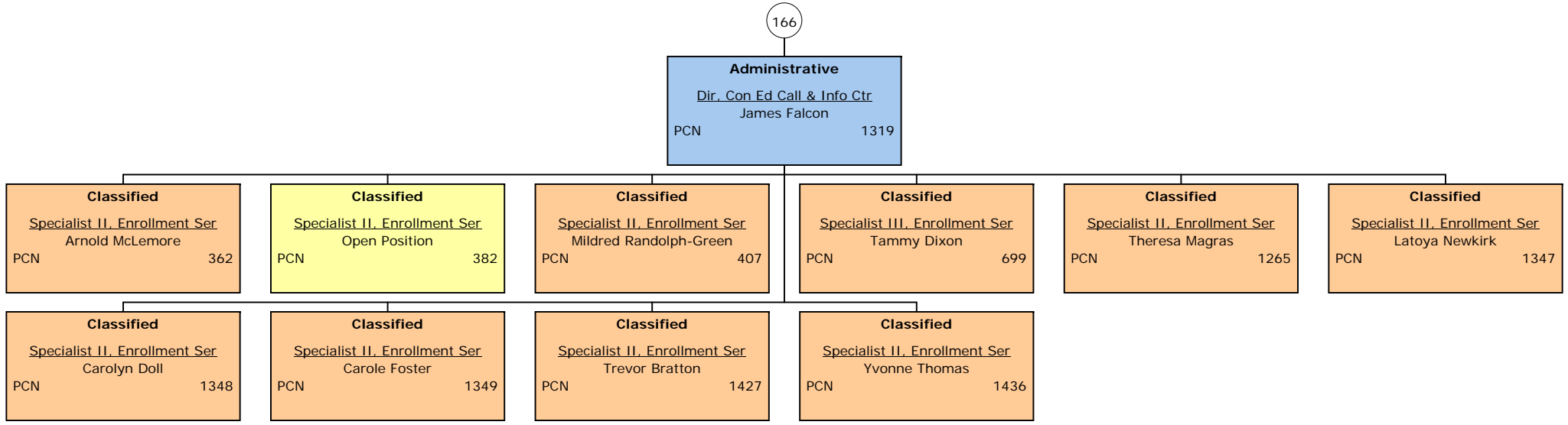

Organizational Chart FY 2017

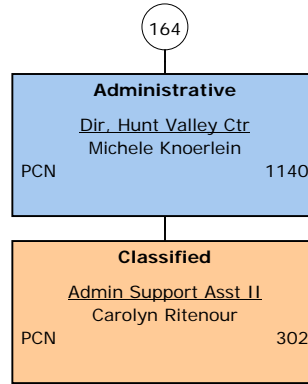

Organizational Chart FY 2017

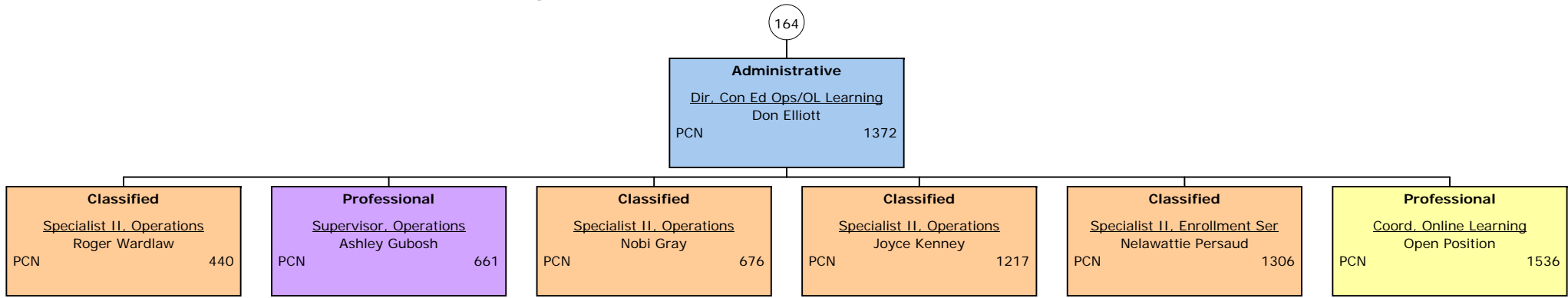

Organizational Chart FY 2017

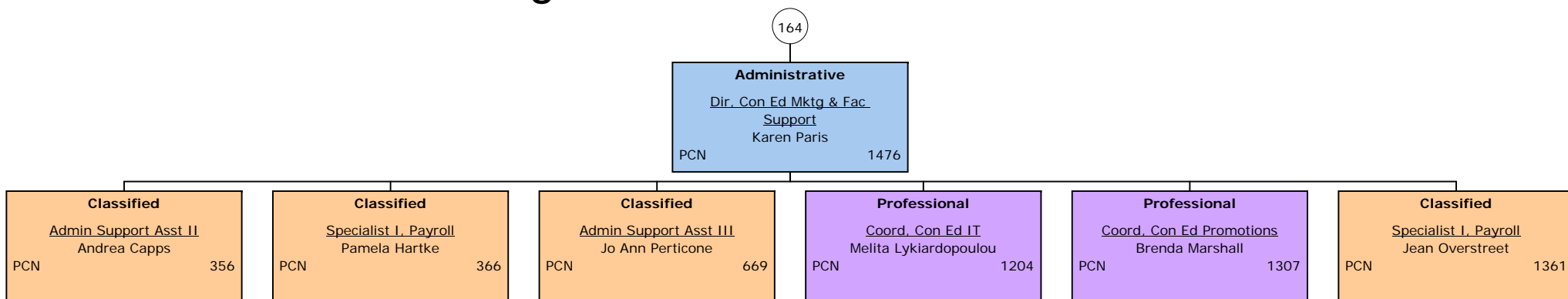

Organizational Chart FY 2017

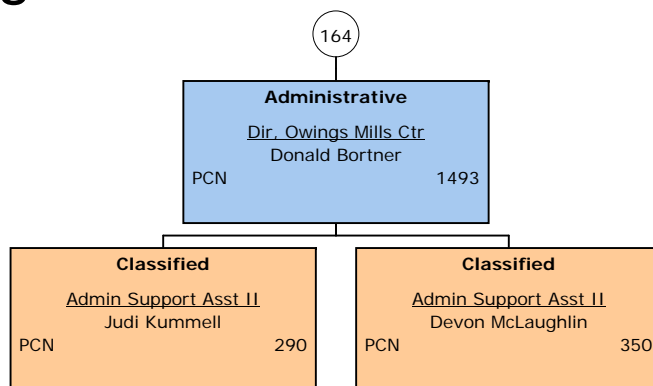

Organizational Chart FY 2017

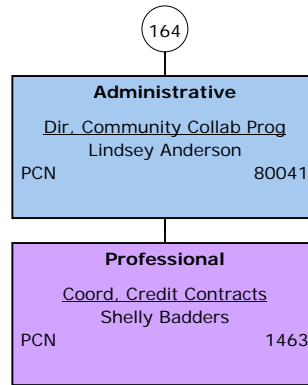

Organizational Chart FY 2017

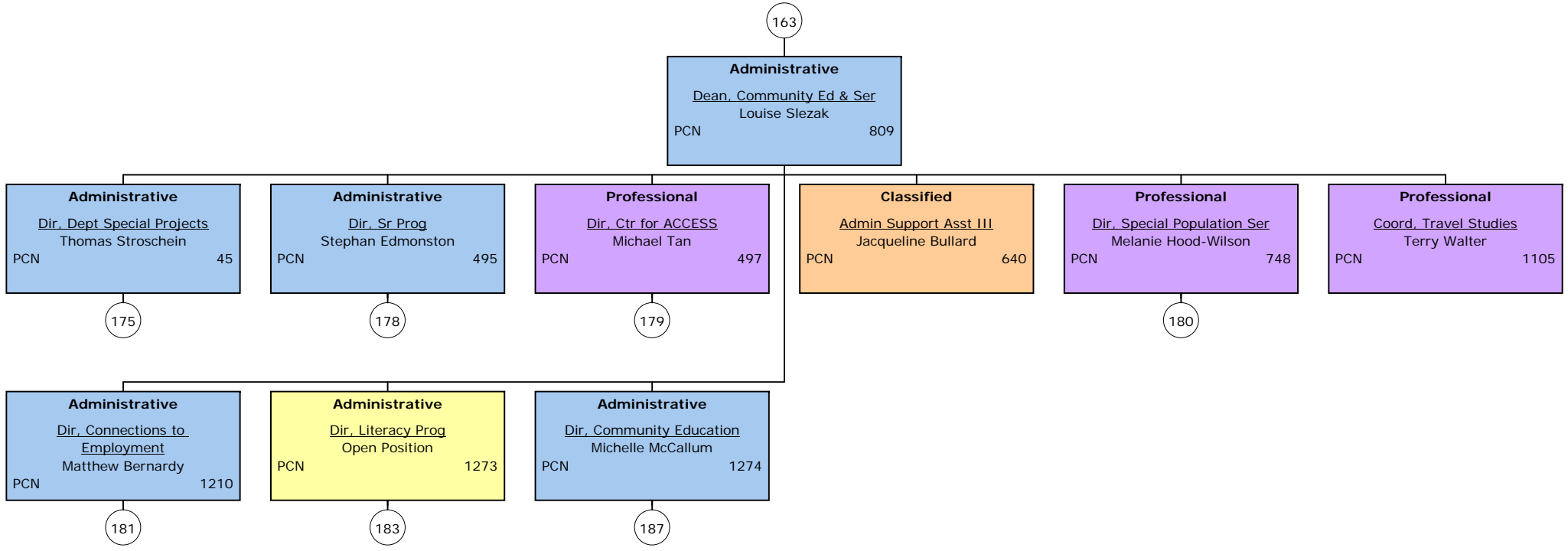

Organizational Chart FY 2017

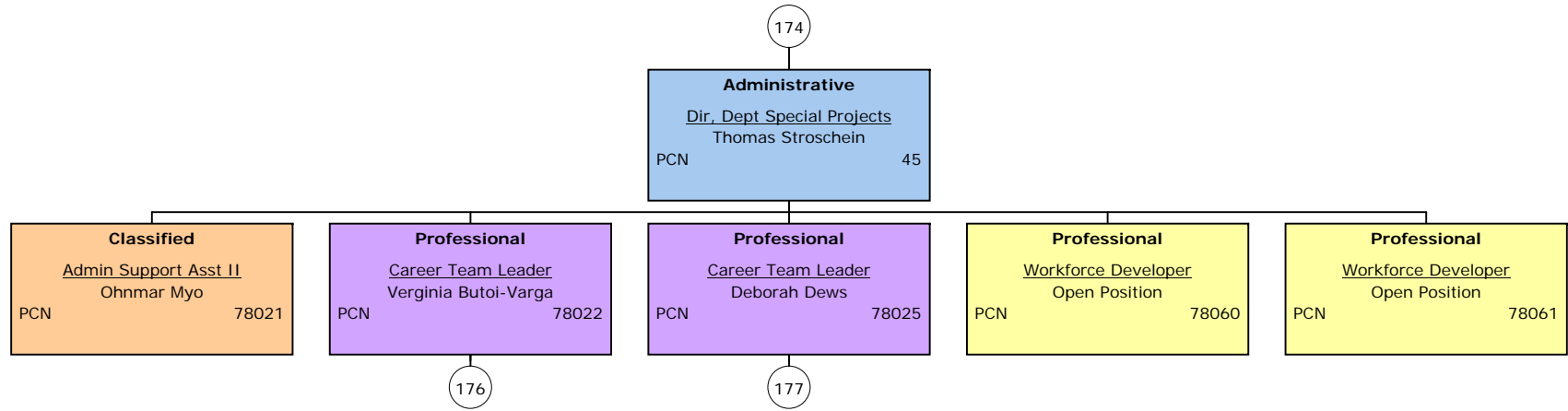

Organizational Chart FY 2017

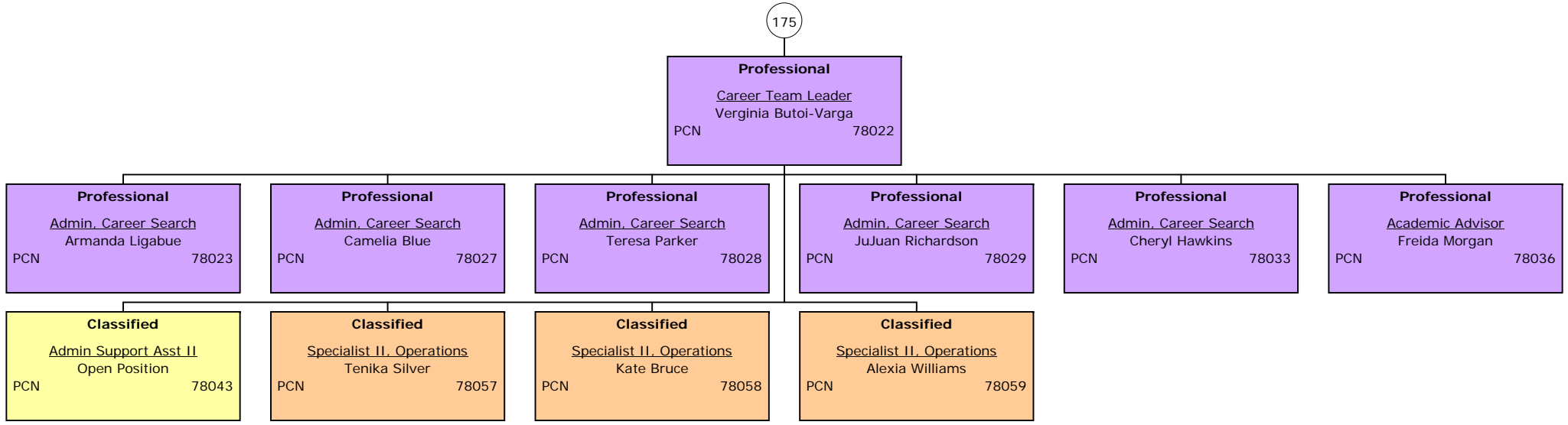

Organizational Chart FY 2017

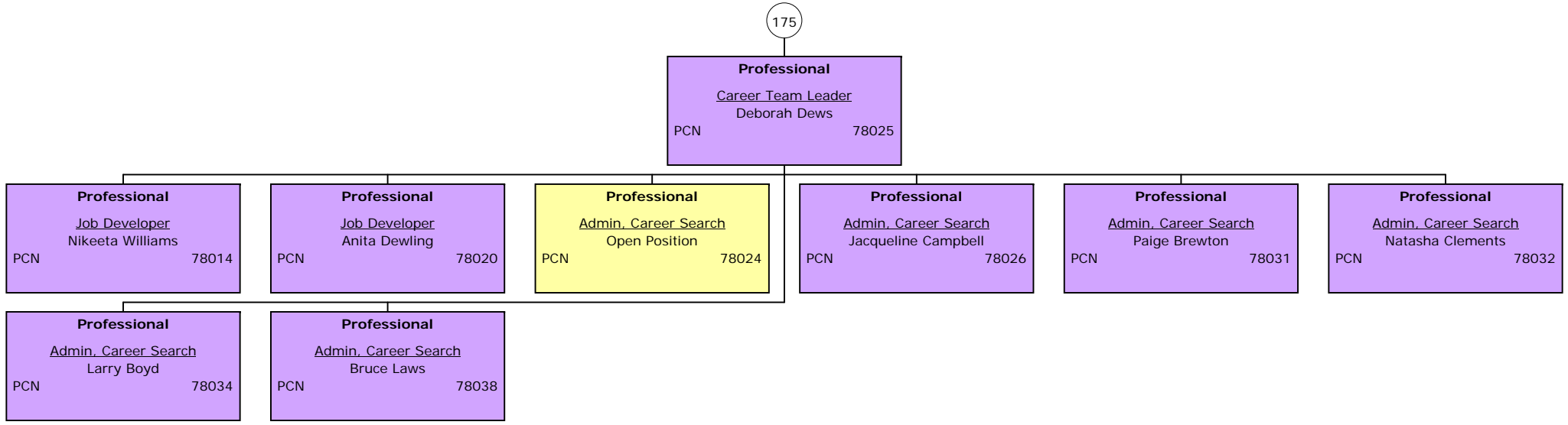

Organizational Chart FY 2017

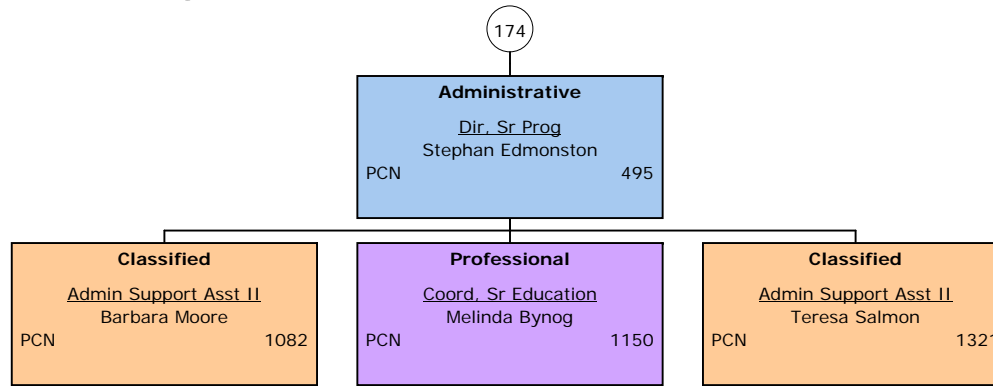

Organizational Chart FY 2017

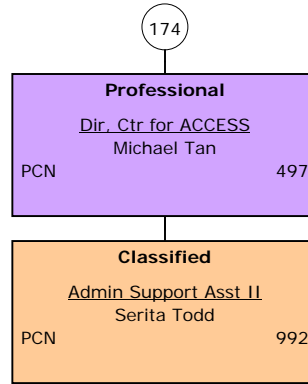

Organizational Chart FY 2017

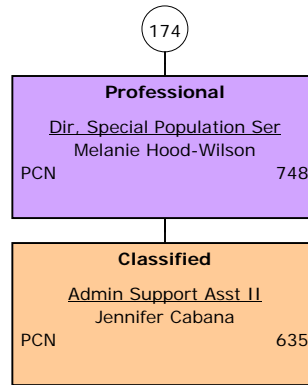

Organizational Chart FY 2017

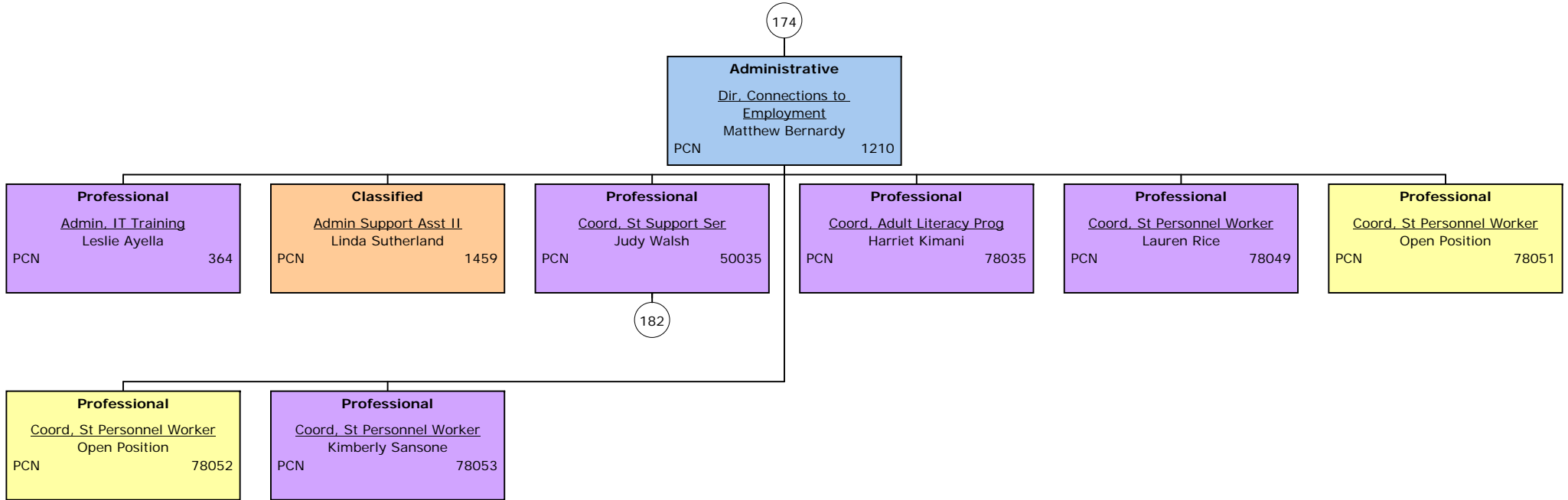

Organizational Chart FY 2017

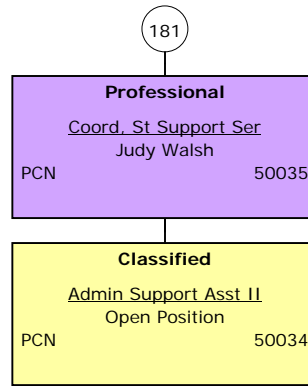

Organizational Chart FY 2017

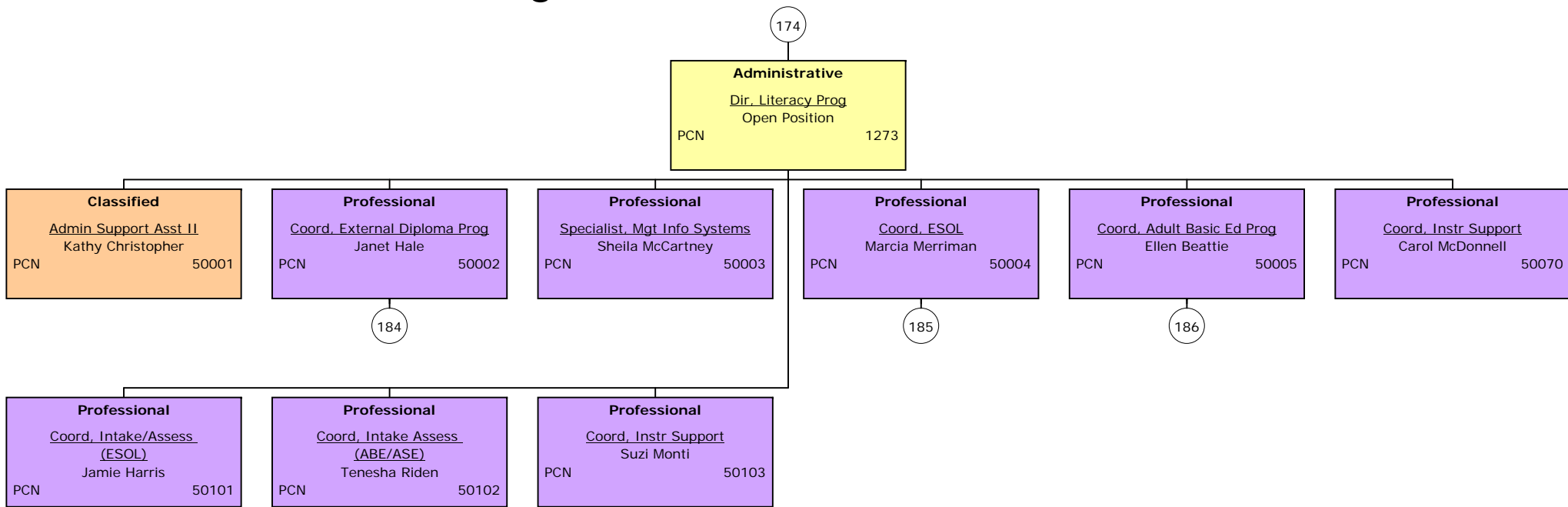

Organizational Chart FY 2017

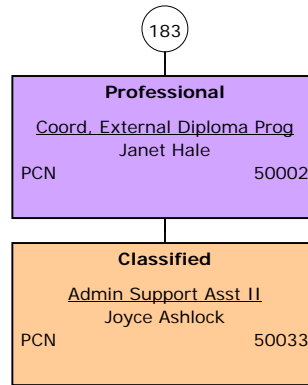

Organizational Chart FY 2017

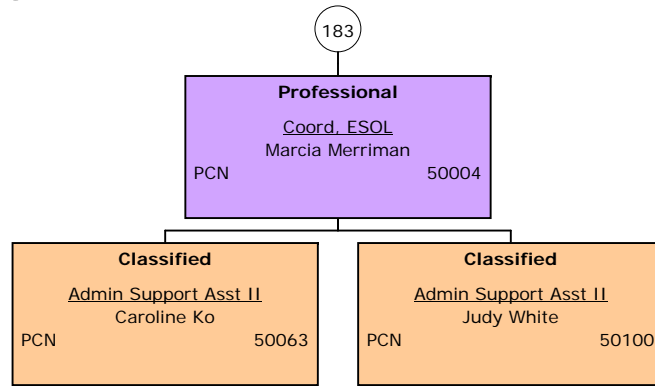

Organizational Chart FY 2017

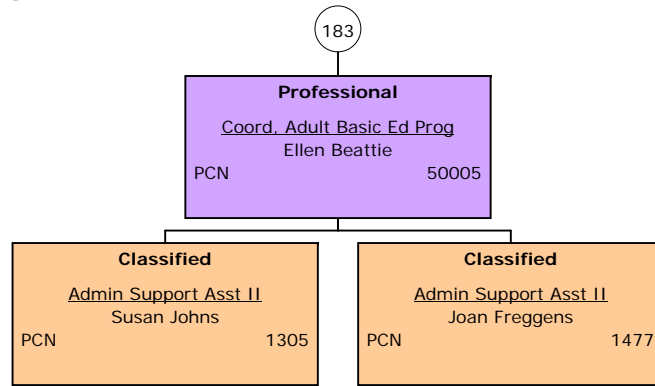

Organizational Chart FY 2017

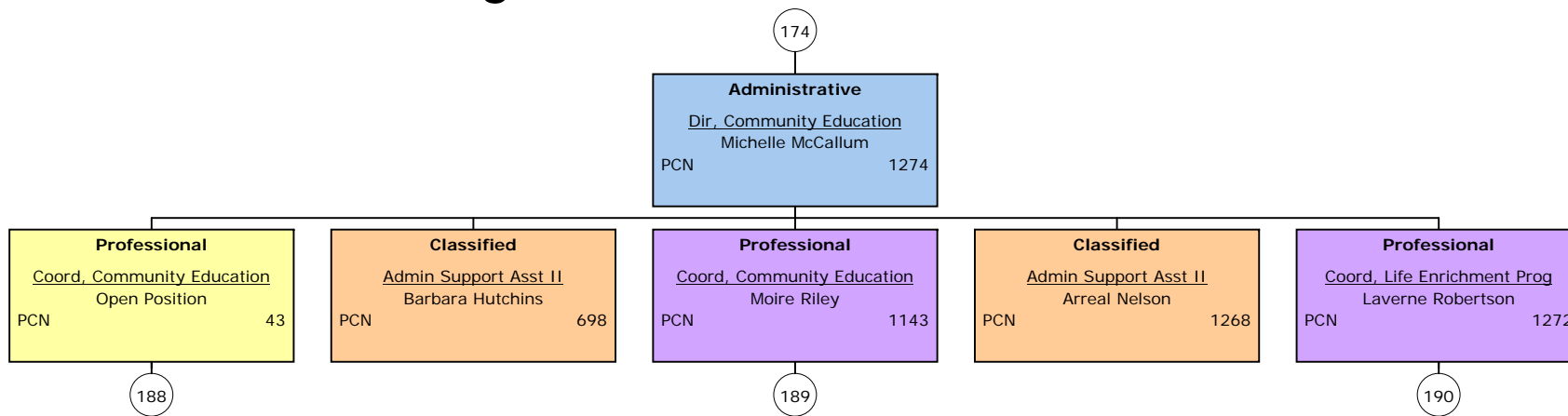

Organizational Chart FY 2017

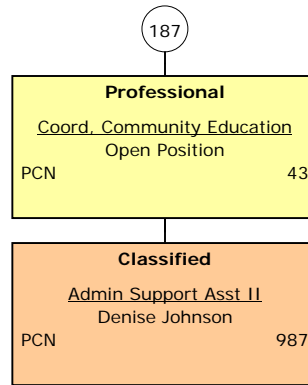

Organizational Chart FY 2017

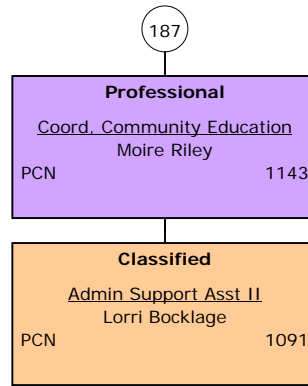

Organizational Chart FY 2017

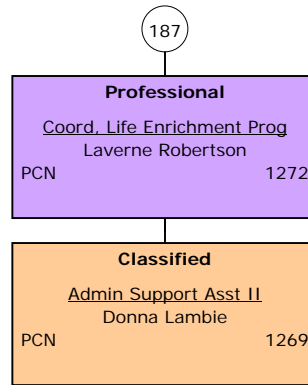

Organizational Chart FY 2017

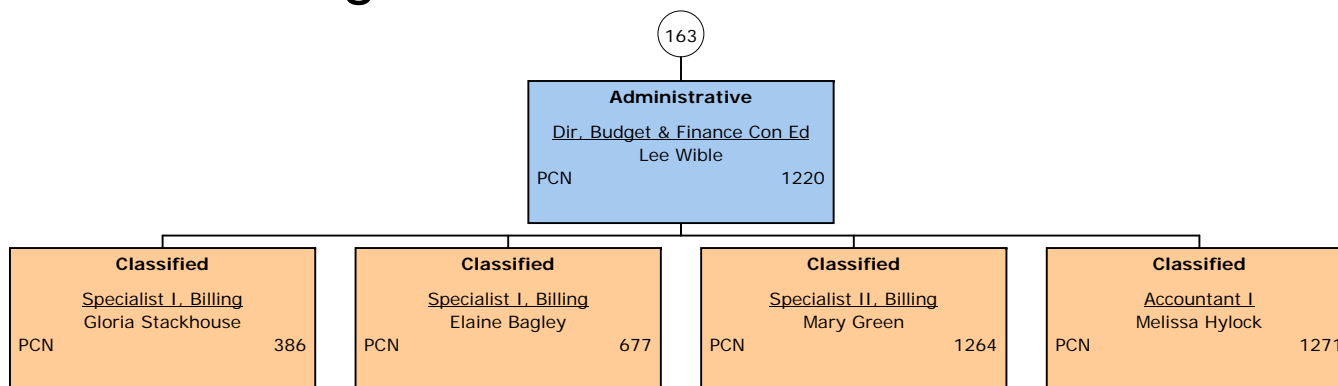

Organizational Chart FY 2017

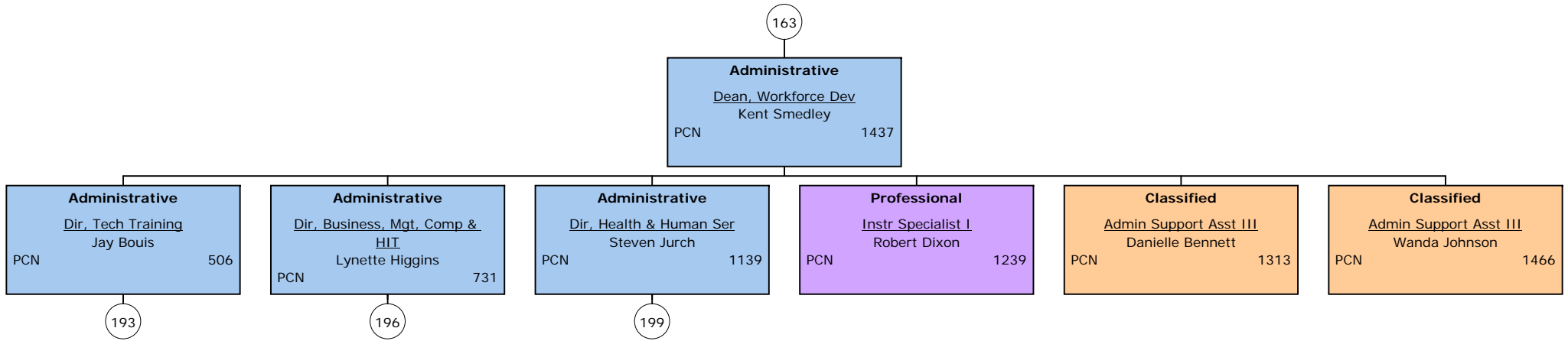

Organizational Chart FY 2017

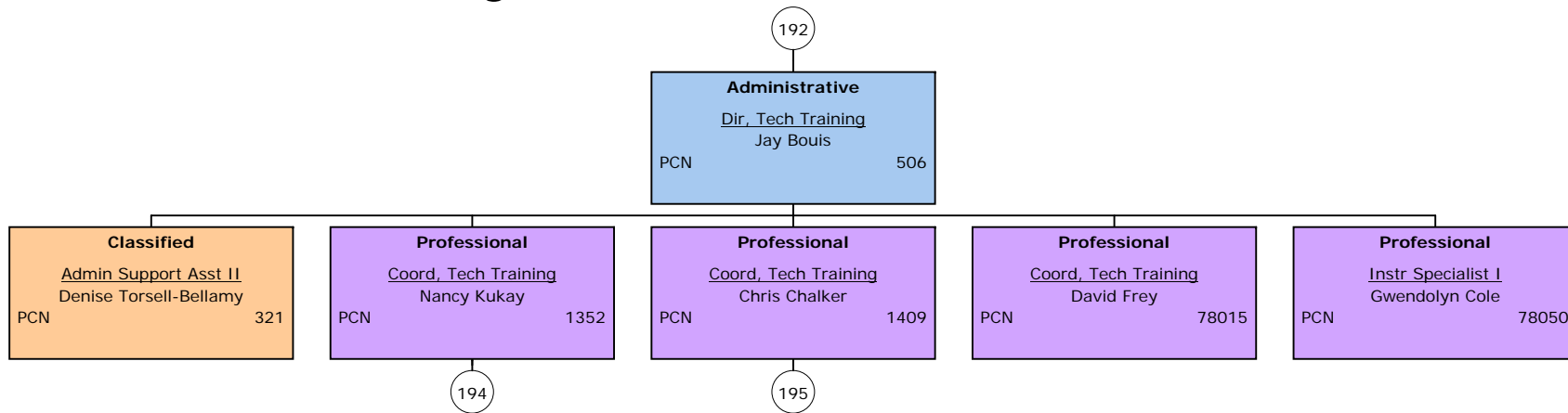

Organizational Chart FY 2017

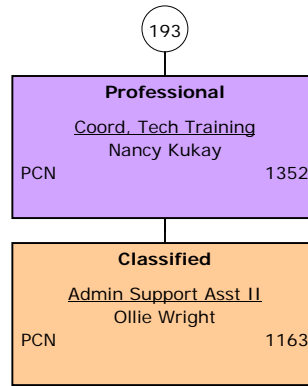

Organizational Chart FY 2017

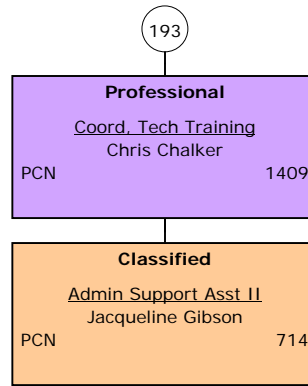

Organizational Chart FY 2017

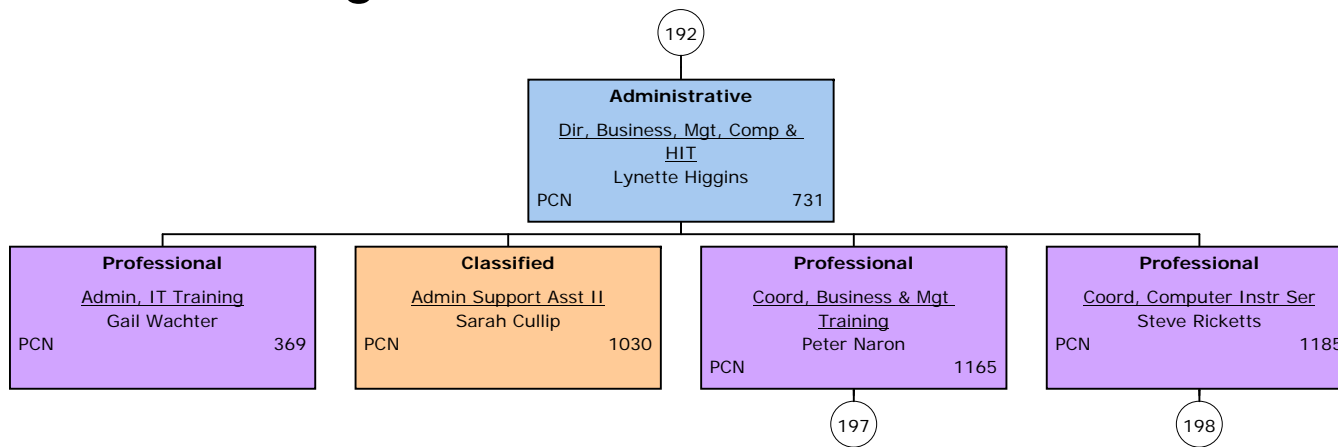

Organizational Chart FY 2017

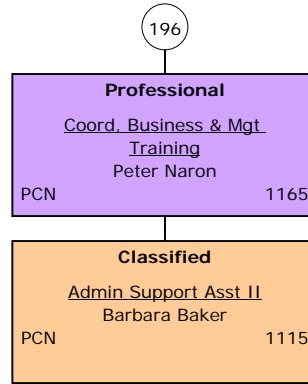

Organizational Chart FY 2017

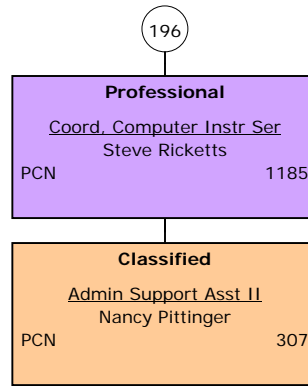

Organizational Chart FY 2017

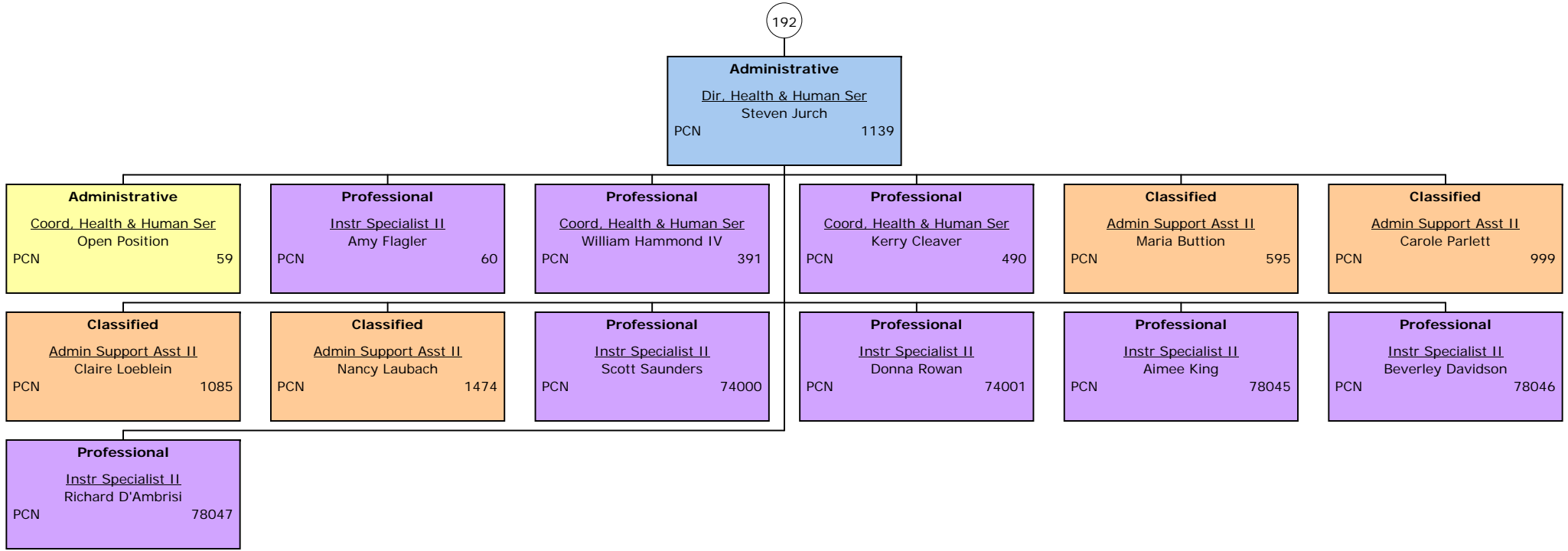

Organizational Chart FY 2017

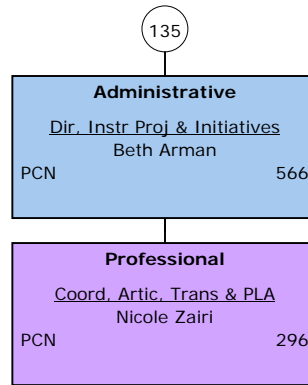

Organizational Chart FY 2017

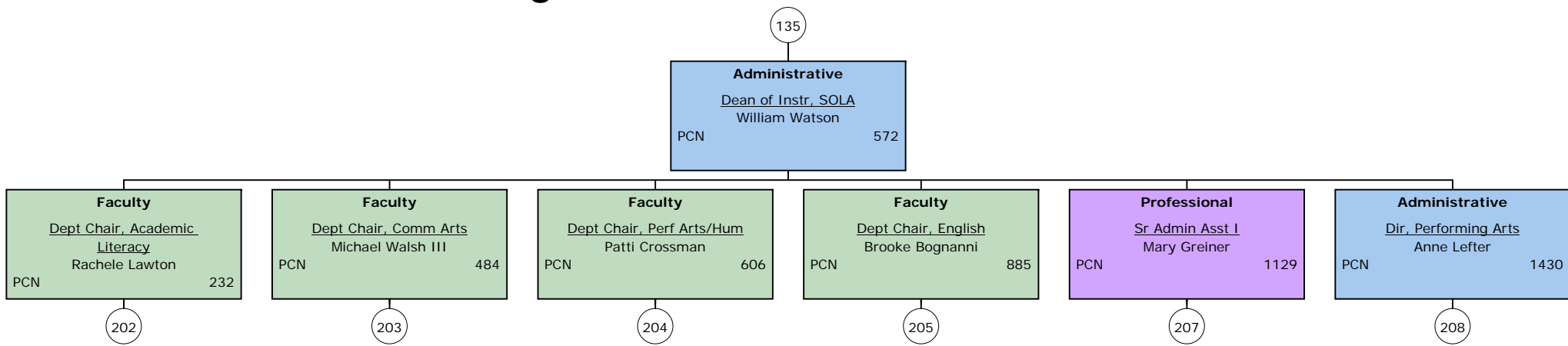

Organizational Chart FY 2017

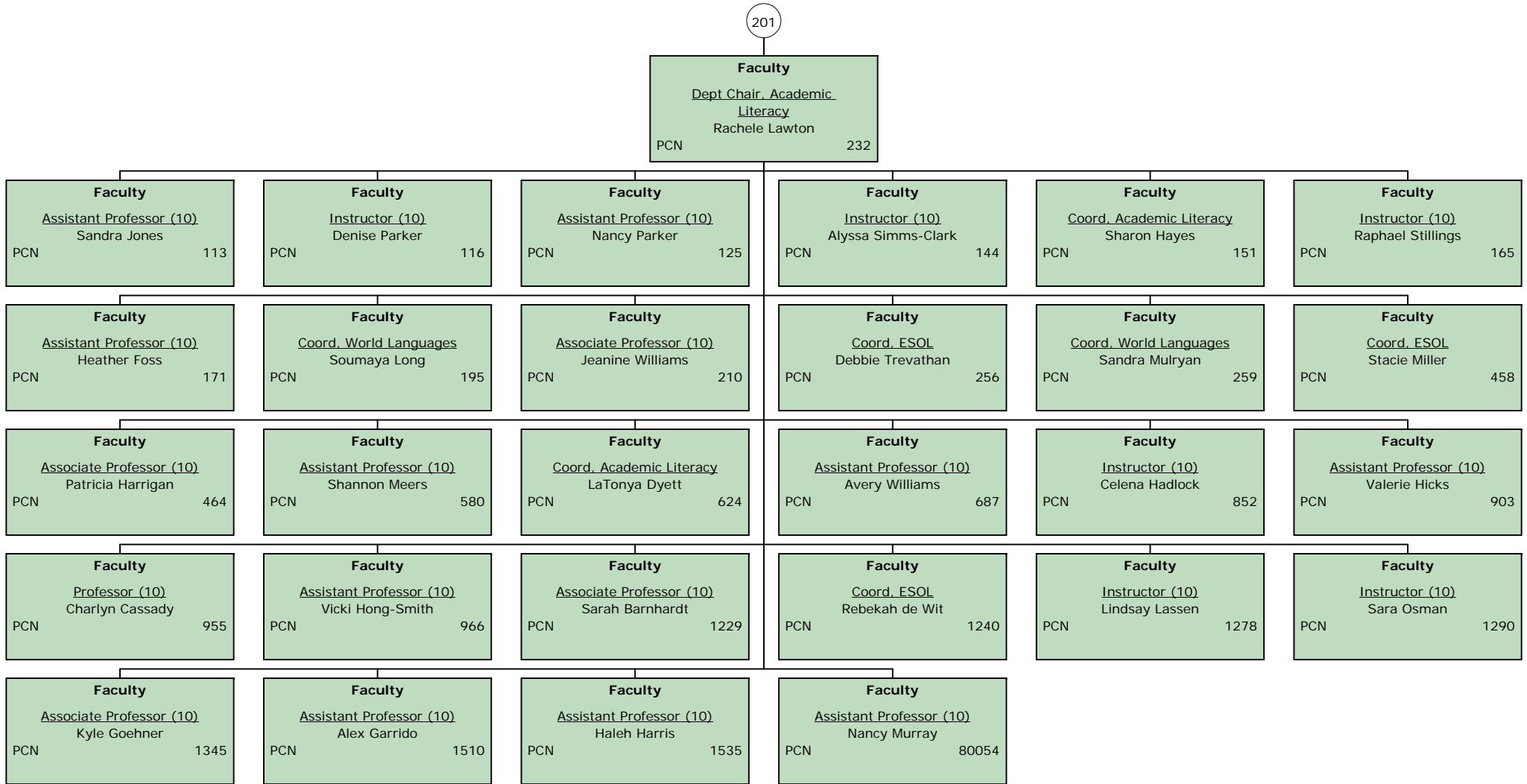

Organizational Chart FY 2017

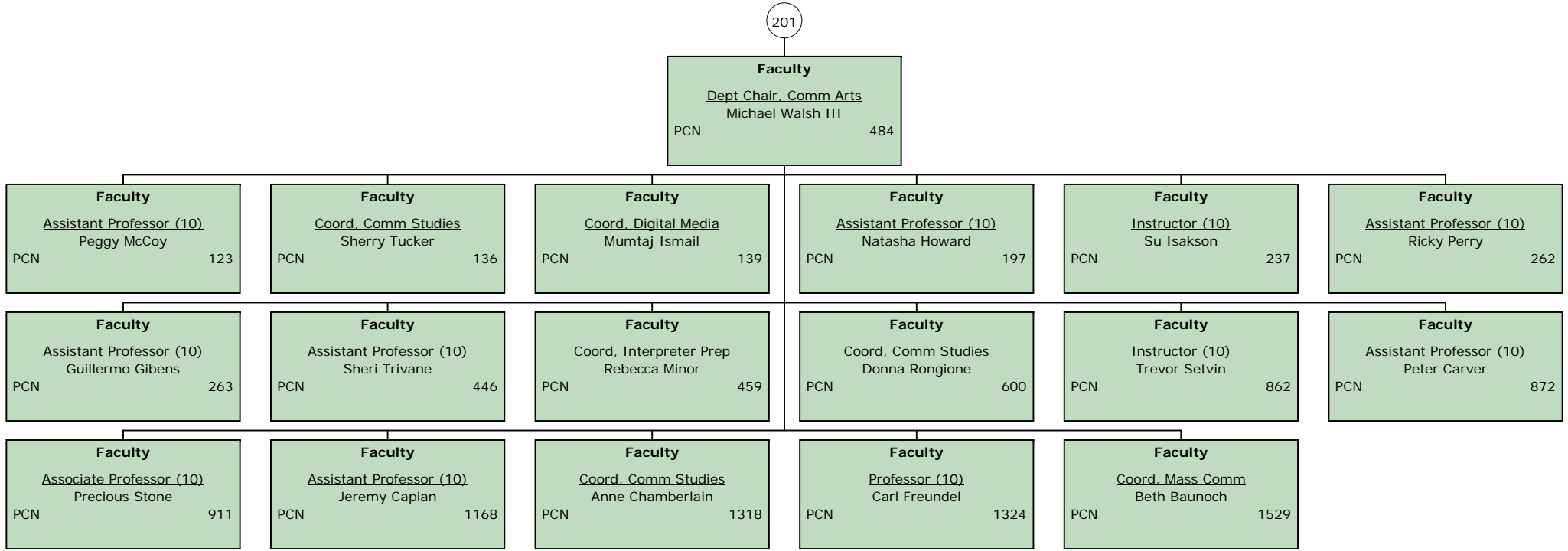

Organizational Chart FY 2017

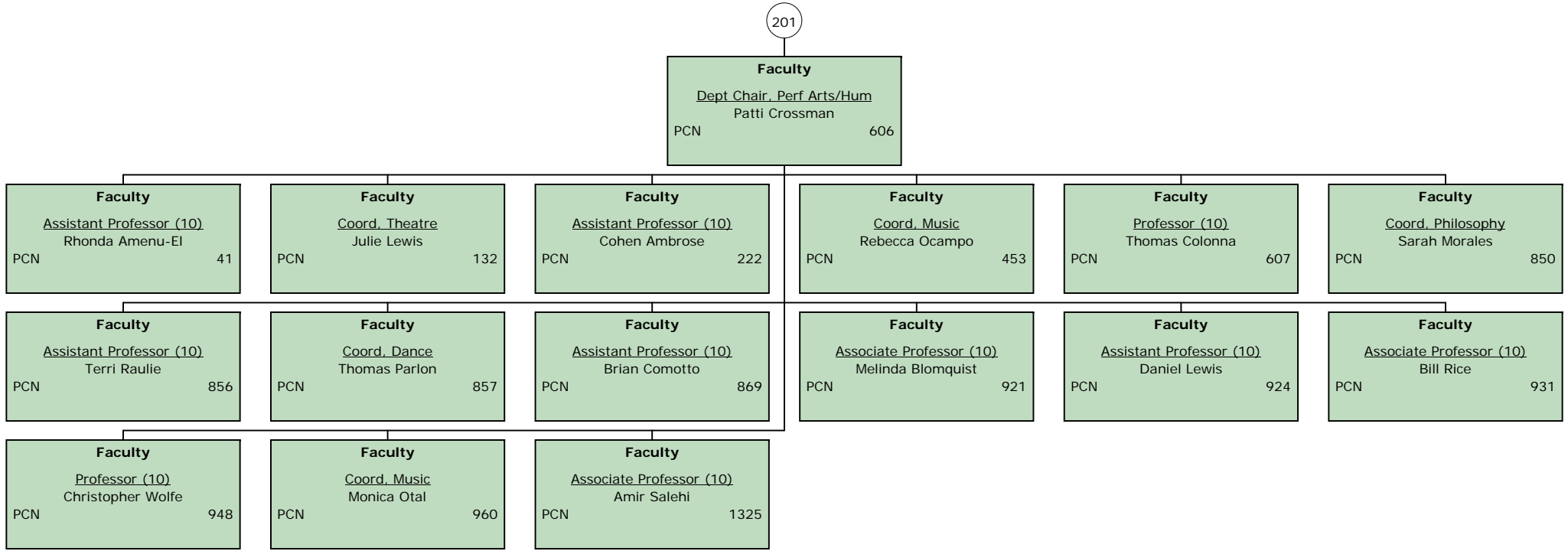

Organizational Chart FY 2017

201

Faculty
Dept Chair, English
 Brooke Bognanni
 PCN 885

Faculty <u>Assistant Professor (10)</u> John Casey PCN 124	Faculty <u>Professor (10)</u> Carol Joseph PCN 134	Faculty <u>Assistant Professor (10)</u> Melvin Berry PCN 147	Faculty <u>Associate Professor (10)</u> Andrew Rusnak Jr PCN 162	Faculty <u>Associate Professor (10)</u> Sandra Grady PCN 169	Faculty <u>Assistant Professor (10)</u> Jacqueline Scott PCN 173
--	--	--	--	--	--

Faculty <u>Instructor (10)</u> Open Position PCN 175	Faculty <u>Assistant Professor (10)</u> Amy Wilson PCN 179	Faculty <u>Assistant Professor (10)</u> Stephanie Briggs PCN 185	Faculty <u>Coord, English</u> Evan Balkan PCN 191	Faculty <u>Assistant Professor (10)</u> Barbara Crawford PCN 194	Faculty <u>Assistant Professor (10)</u> Jamey Gallagher PCN 207
--	--	--	---	--	---

Faculty <u>Instructor (10)</u> Maura Hill PCN 208	Faculty <u>Assistant Professor (10)</u> David Hewitt PCN 212	Faculty <u>Associate Professor (10)</u> Linda De La Ysla PCN 223	Faculty <u>Assistant Professor (10)</u> Jewel Jackson PCN 254	Faculty <u>Assistant Professor (10)</u> Anjilli Babbar PCN 260	Faculty <u>Assistant Professor (10)</u> Ryan Donnelly PCN 512
---	--	--	---	--	---

Faculty <u>Assistant Professor (10)</u> Natasha Cole-Leonard PCN 558	Faculty <u>Associate Professor (10)</u> Mary Jo Garcia-Brown PCN 577	Faculty <u>Associate Professor (10)</u> Jeremy Trucker PCN 578	Faculty <u>Professor (10)</u> Margy McCampbell PCN 579	Faculty <u>Assistant Professor (10)</u> Anne Roberts PCN 587	Faculty <u>Professor (10)</u> David Truscello PCN 605
--	--	--	--	--	---

Faculty <u>Assistant Professor (10)</u> Osen Bowser PCN 610	Faculty <u>Assistant Professor (10)</u> Jadi Keambiroiro PCN 774	Faculty <u>Professor (10)</u> Anna Rogers PCN 817	Faculty <u>Instructor (10)</u> Elsbeth Mantler PCN 840	Faculty <u>Assistant Professor (10)</u> Gregory Campbell PCN 843	Faculty <u>Professor (10)</u> Linda Weinhouse PCN 844
---	--	---	--	--	---

Faculty <u>Assistant Professor (10)</u> Luana Rarey PCN 845	Faculty <u>Professor (10)</u> Rae Rosenthal PCN 870	Faculty <u>Associate Professor (10)</u> Cheryl Scott PCN 877	Faculty <u>Assistant Professor (10)</u> Annmarie Chiarini PCN 878	Faculty <u>Coord, English</u> Patricia Rennie PCN 890	Faculty <u>Assistant Professor (10)</u> Gretchen Rudham PCN 894
---	---	--	---	---	---

206

Faculty <u>Associate Professor (10)</u> Fawcett Dunstan PCN 901	Faculty <u>Professor (10)</u> Kim Jensen PCN 918	Faculty <u>Associate Professor (10)</u> Robert Miller PCN 934	Faculty <u>Associate Professor (10)</u> Carr Kizzier PCN 950	Faculty <u>Assistant Professor (10)</u> Jessica Floyd PCN 1188	Faculty <u>Assistant Professor (10)</u> Rudolph Brathwaite PCN 1279
---	--	---	--	--	---

Faculty <u>Associate Professor (10)</u> Susan Gabriel PCN 1291	Faculty <u>Associate Professor (10)</u> Josette Darden-Obi PCN 1385	Faculty <u>Assistant Professor (10)</u> Megan Schutte PCN 1421	Faculty <u>Coord, English</u> Heather Harris PCN 1509
--	---	--	---

Organizational Chart FY 2017

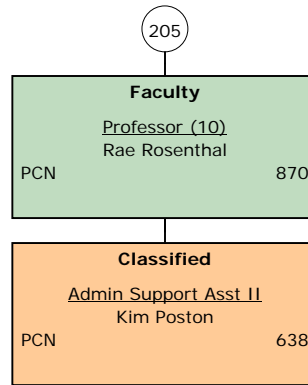

Organizational Chart FY 2017

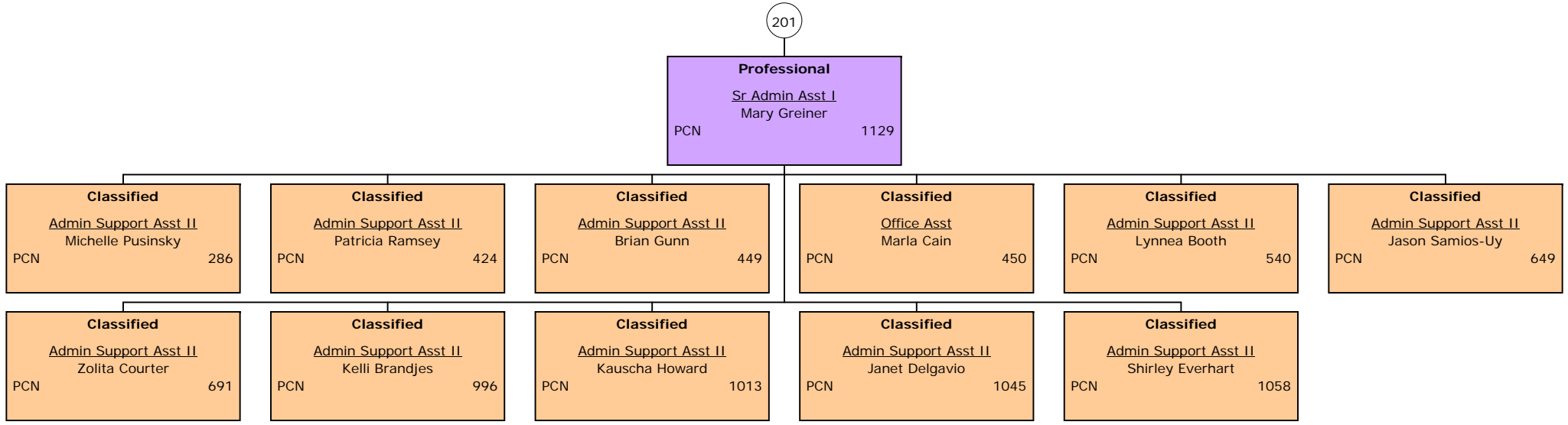

Organizational Chart FY 2017

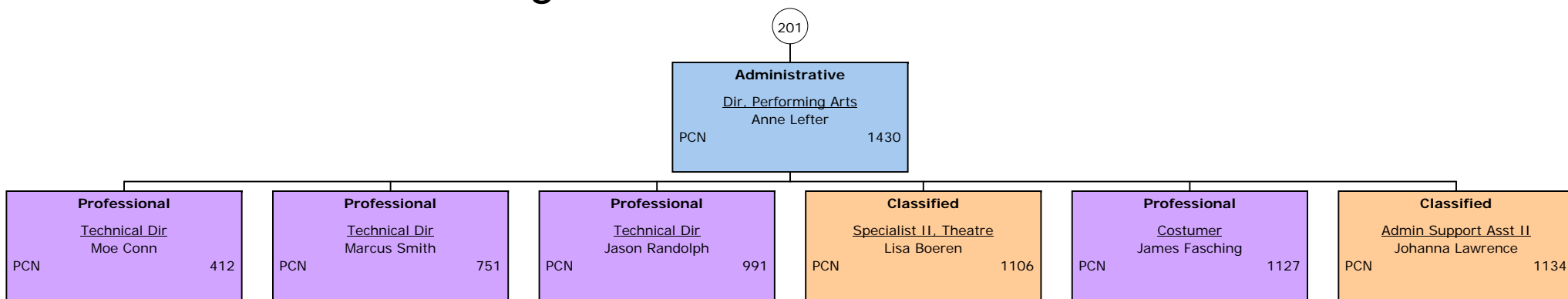

Organizational Chart FY 2017

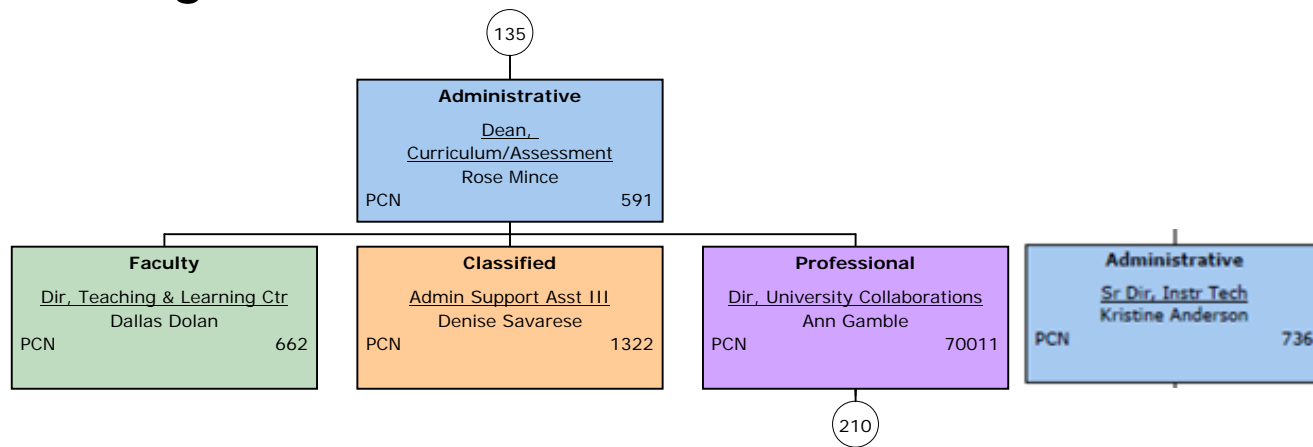

Organizational Chart FY 2017

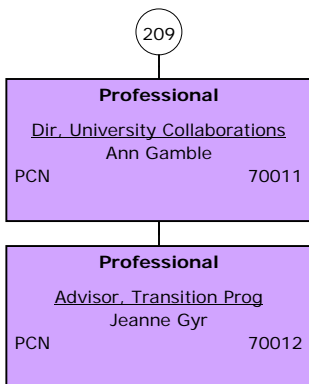

Organizational Chart FY 2017

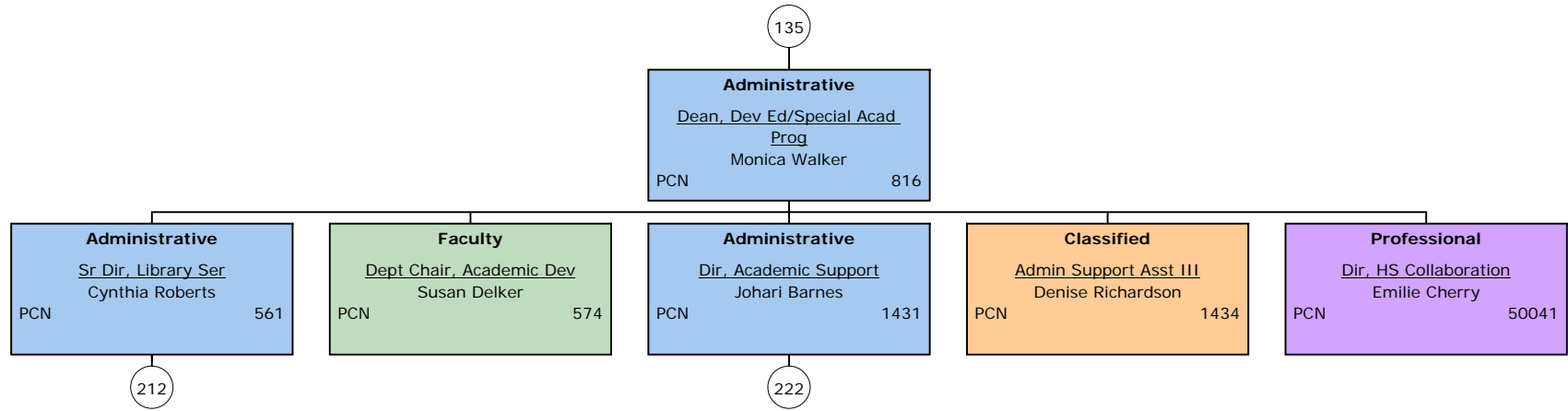

Organizational Chart FY 2017

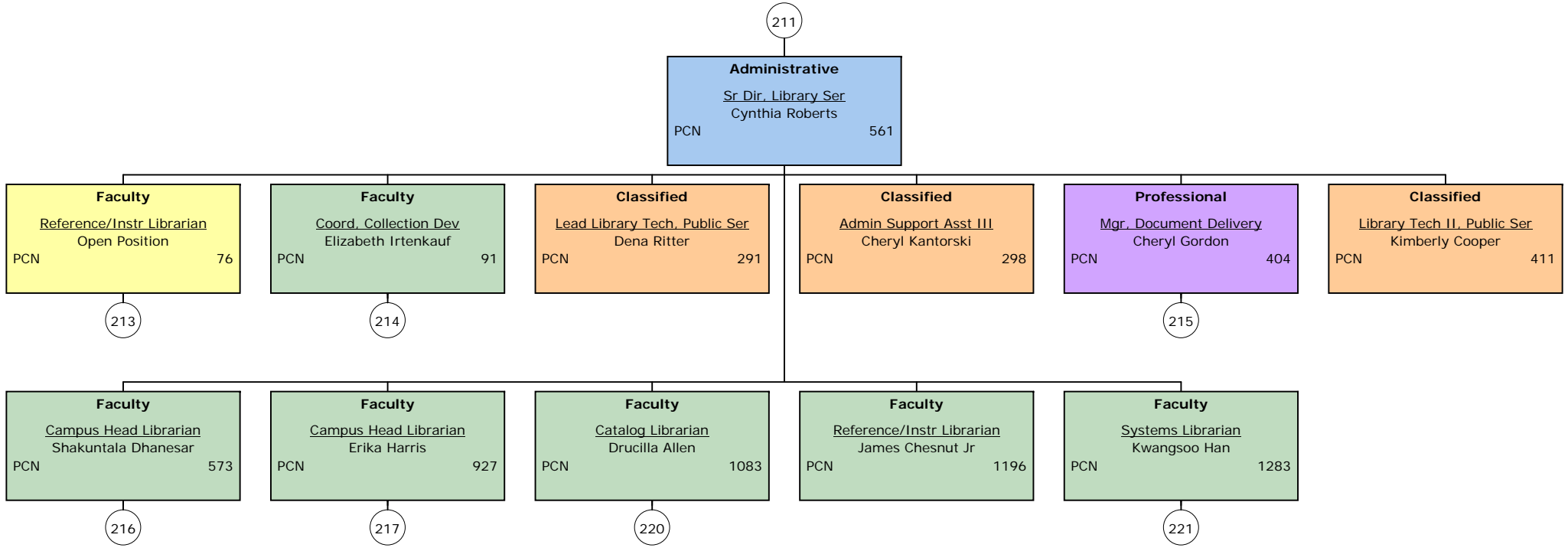

Organizational Chart FY 2017

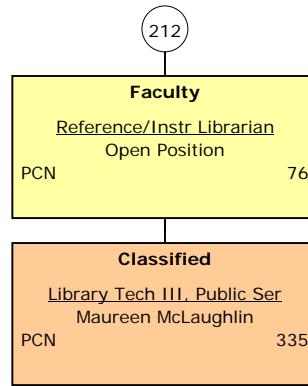

Organizational Chart FY 2017

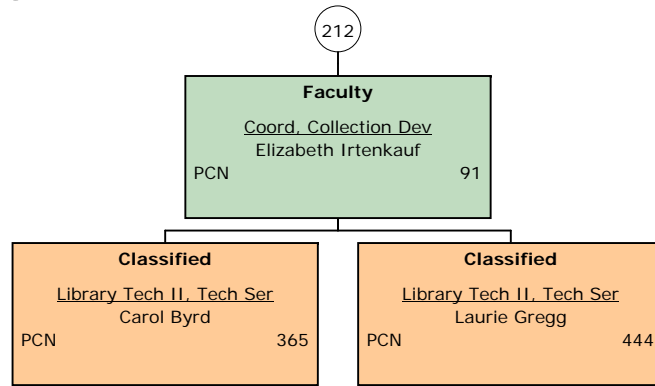

Organizational Chart FY 2017

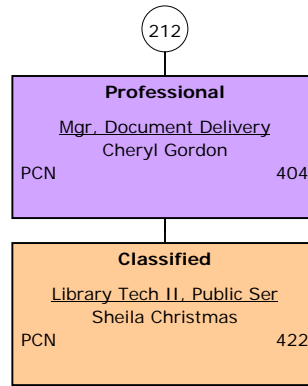

Organizational Chart FY 2017

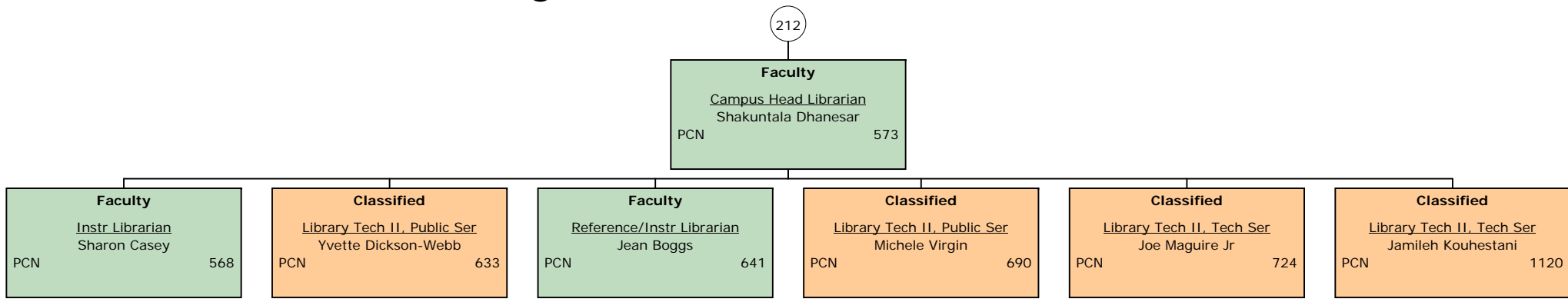

Organizational Chart FY 2017

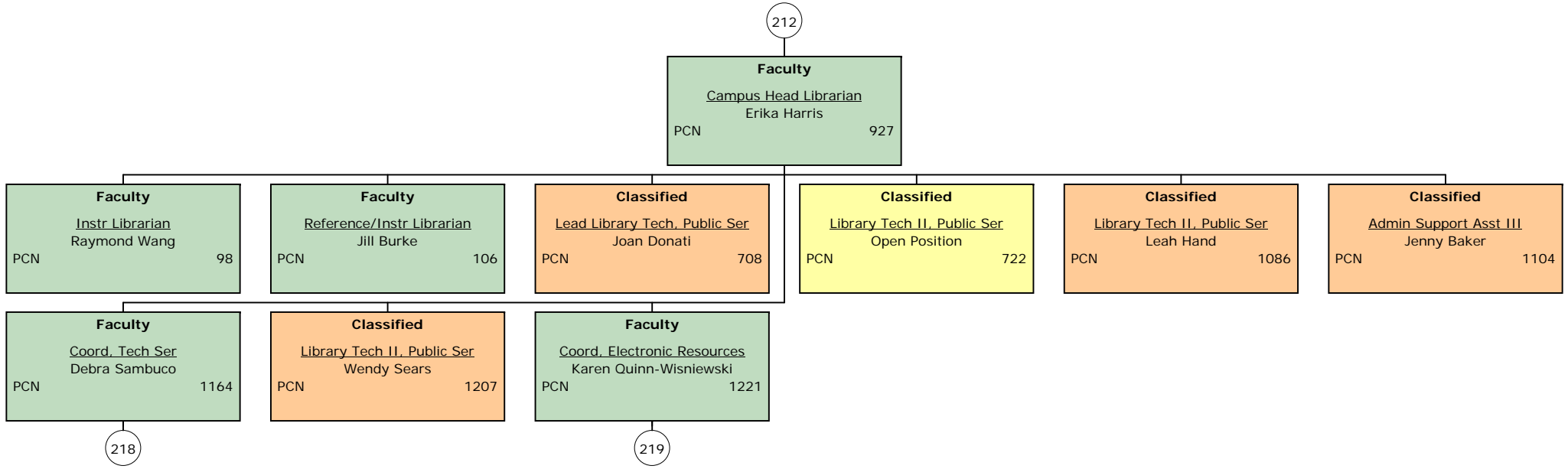

Organizational Chart FY 2017

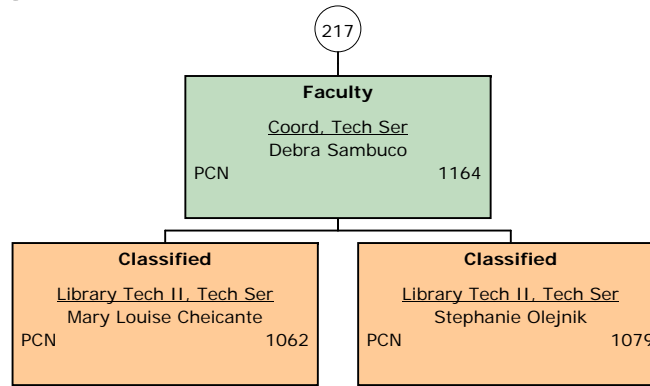

Organizational Chart FY 2017

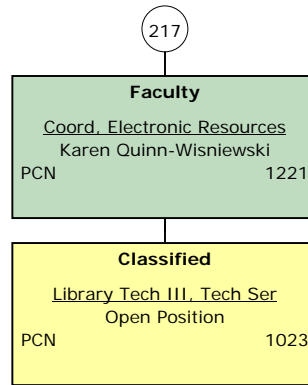

Organizational Chart FY 2017

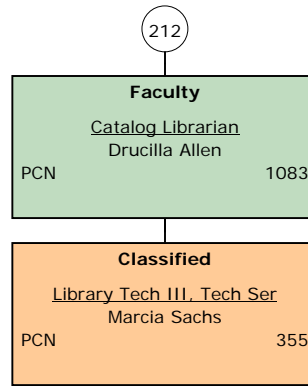

Organizational Chart FY 2017

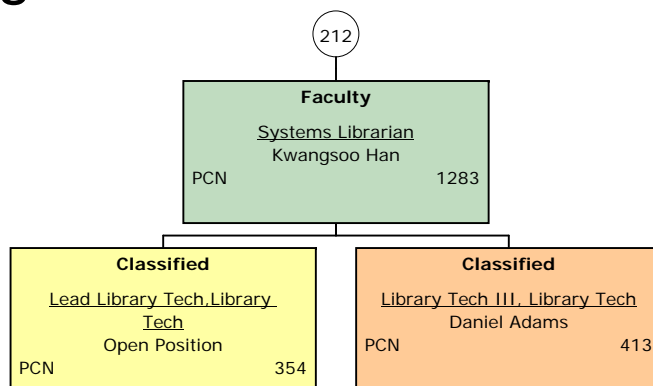

Organizational Chart FY 2017

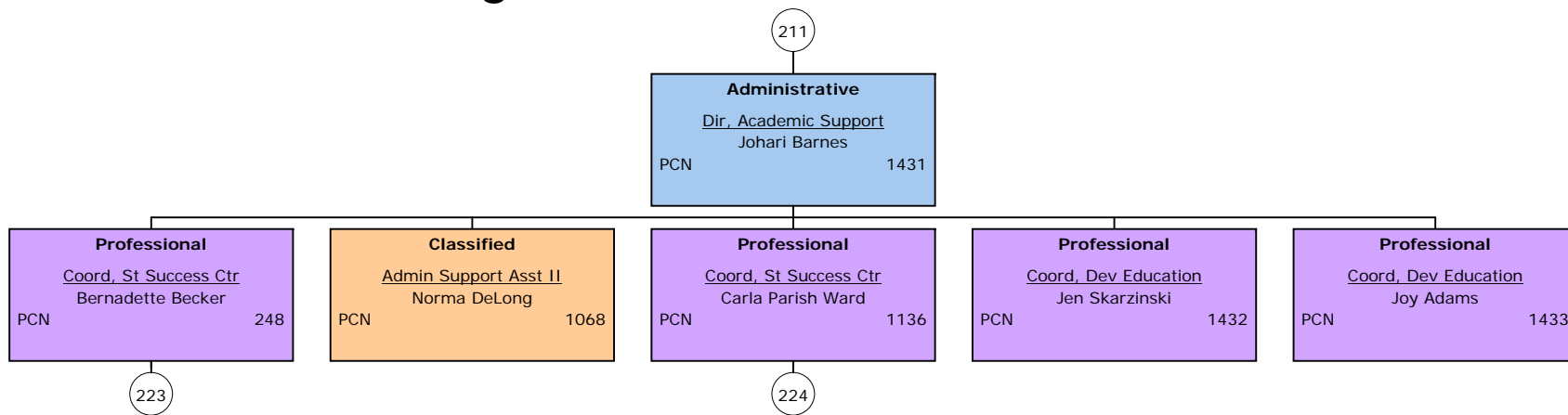

Organizational Chart FY 2017

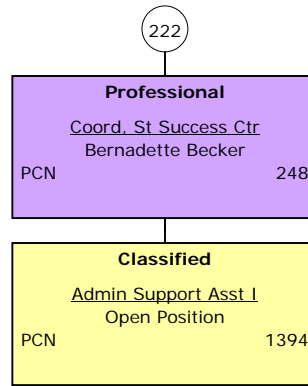

Organizational Chart FY 2017

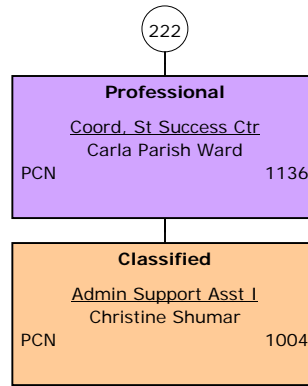

Organizational Chart FY 2017

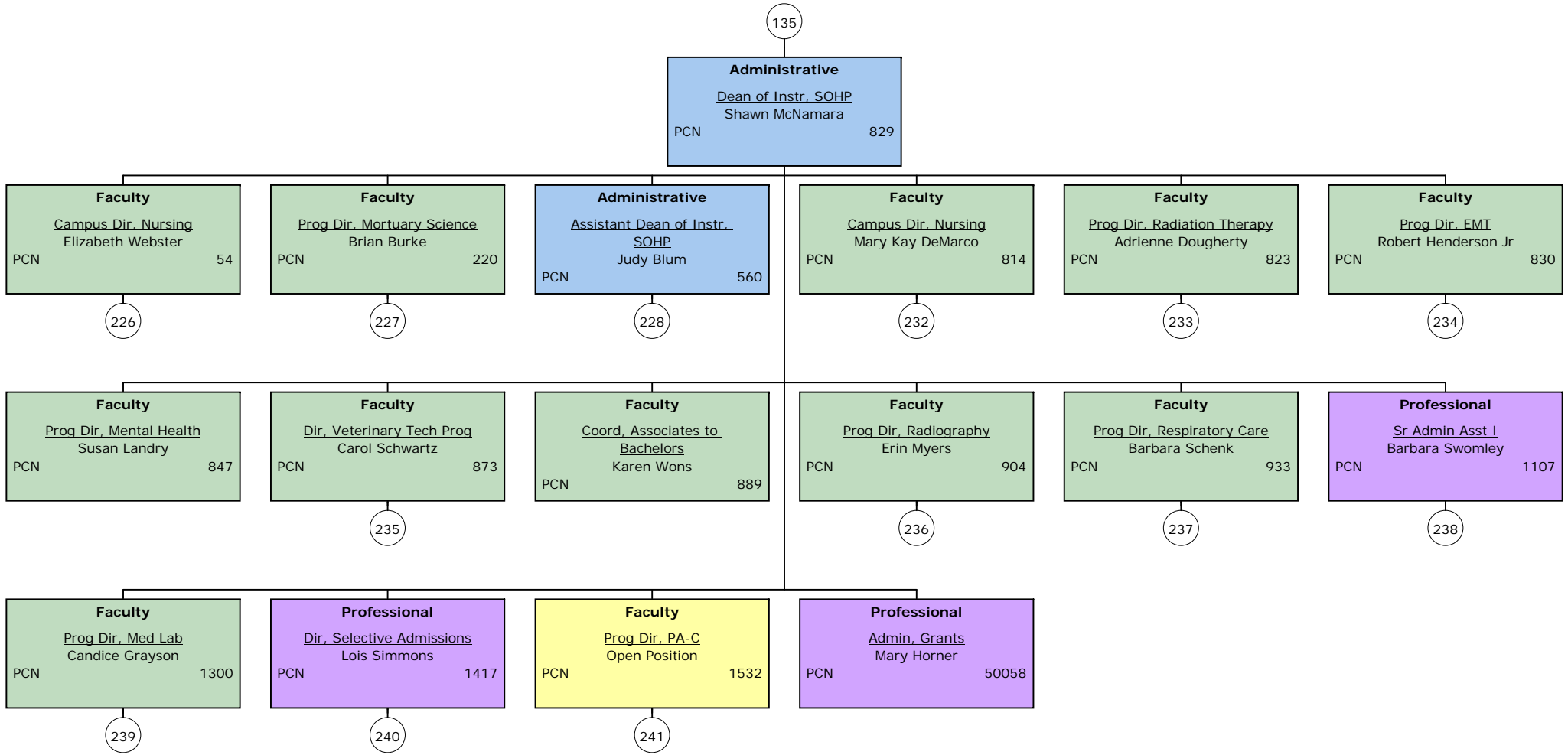

Organizational Chart FY 2017

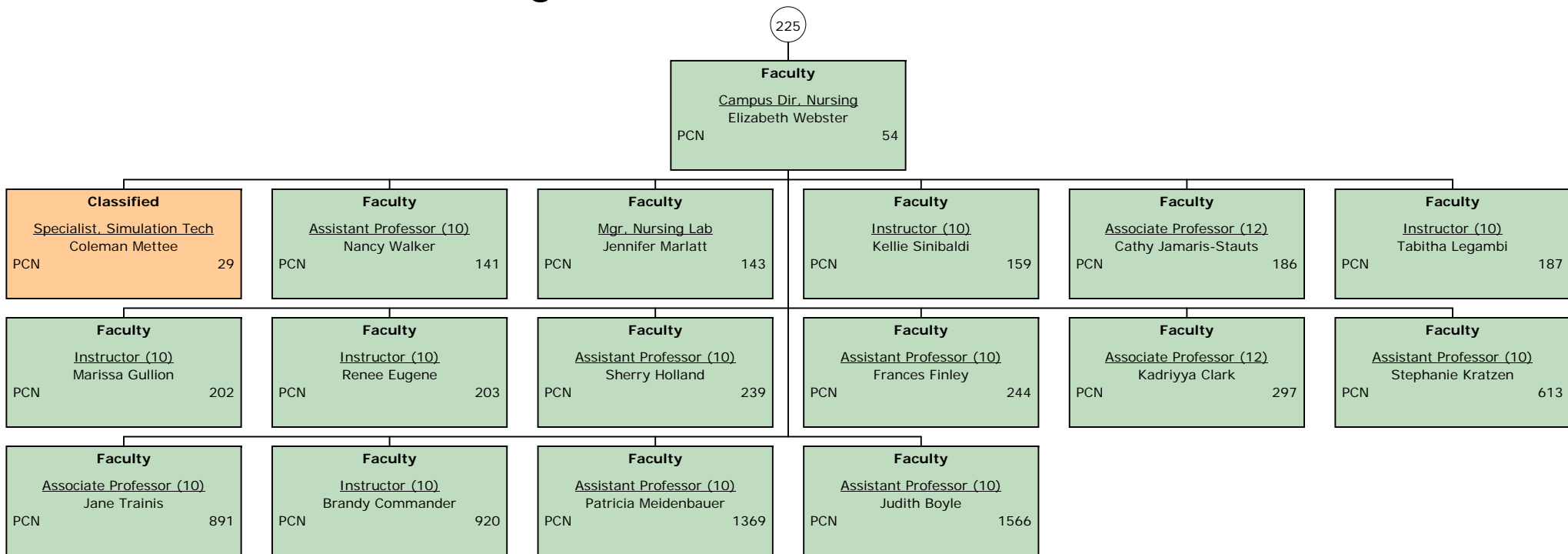

Organizational Chart FY 2017

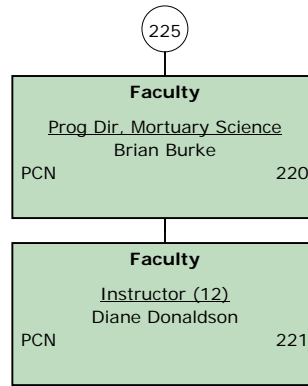

Organizational Chart FY 2017

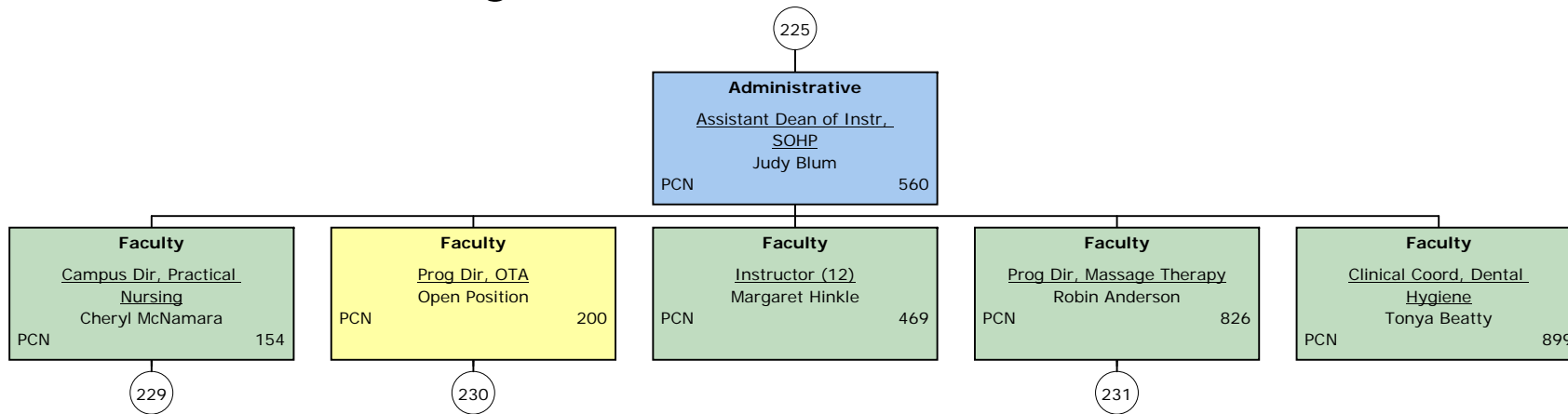

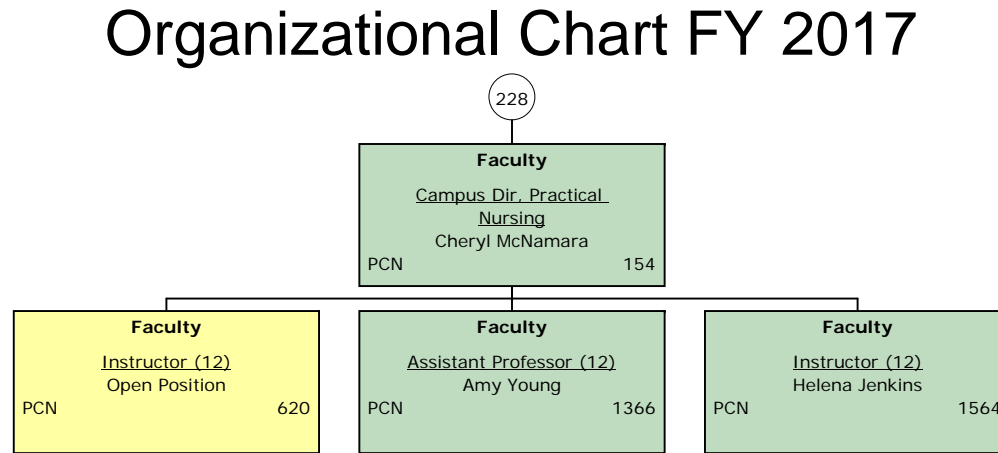

Organizational Chart FY 2017

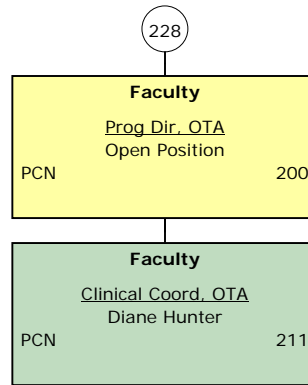

Organizational Chart FY 2017

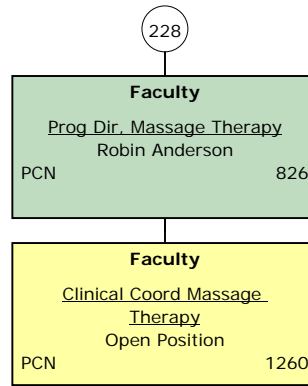

Organizational Chart FY 2017

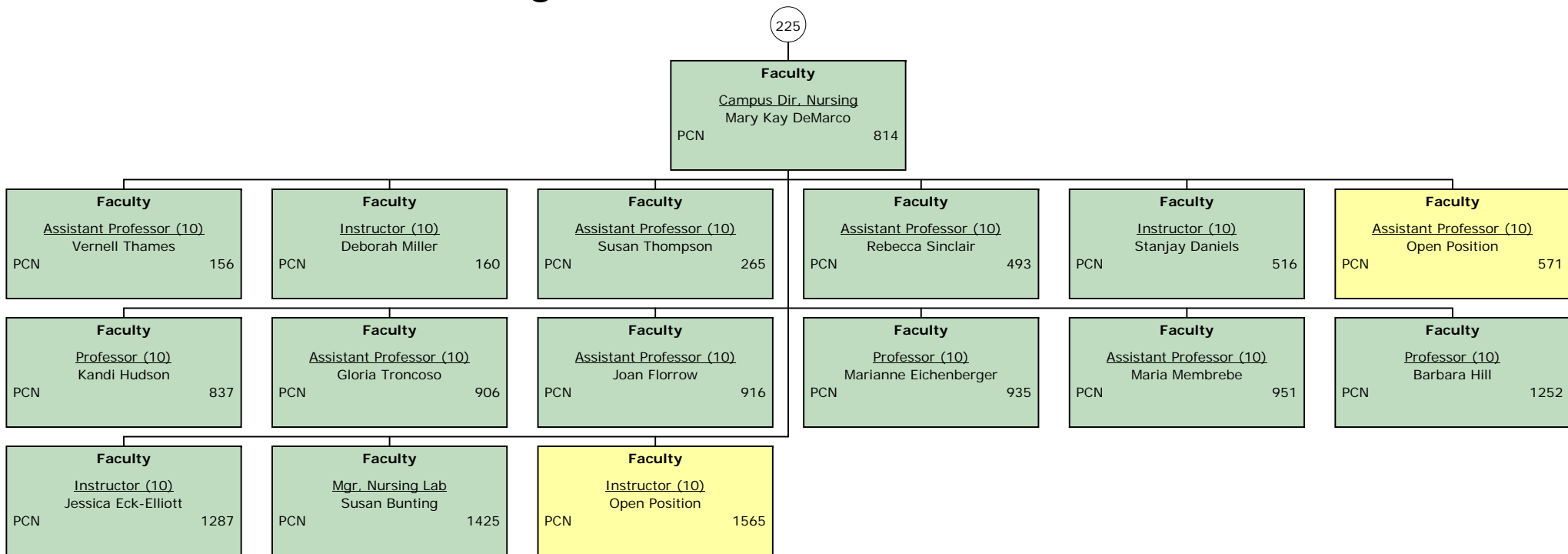

Organizational Chart FY 2017

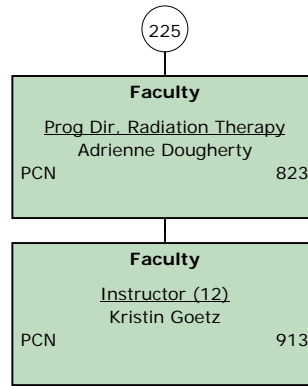

Organizational Chart FY 2017

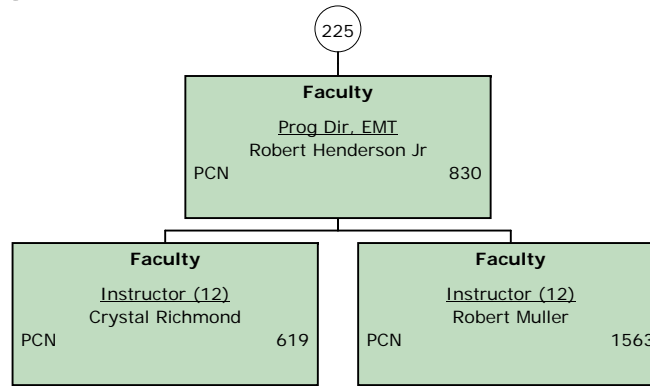

Organizational Chart FY 2017

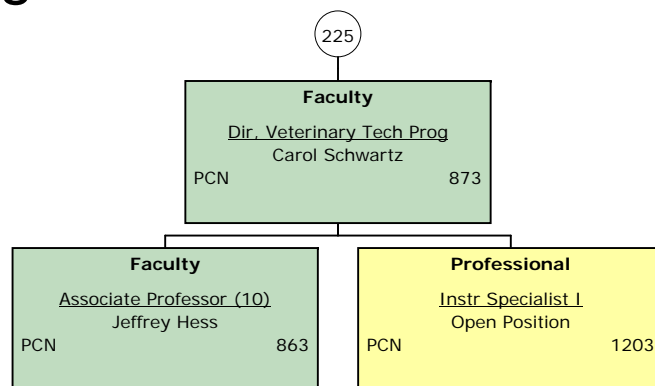

Organizational Chart FY 2017

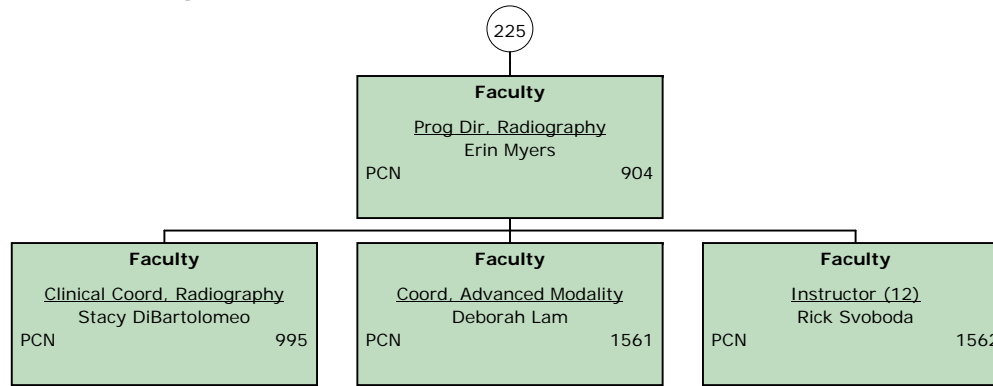

Organizational Chart FY 2017

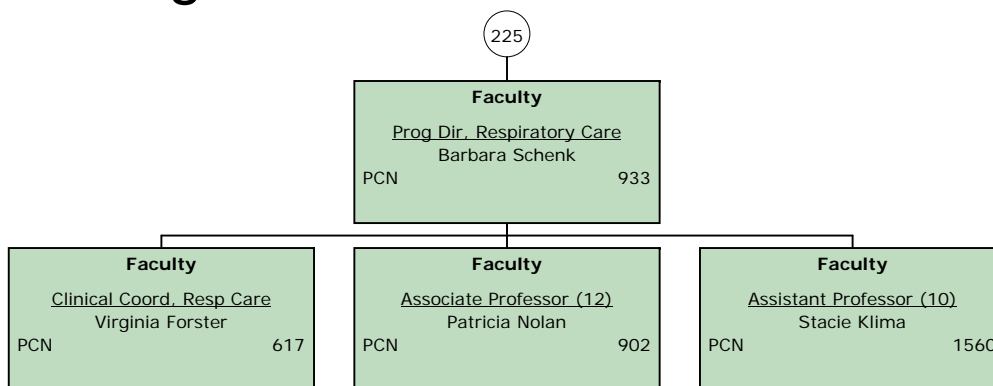

Organizational Chart FY 2017

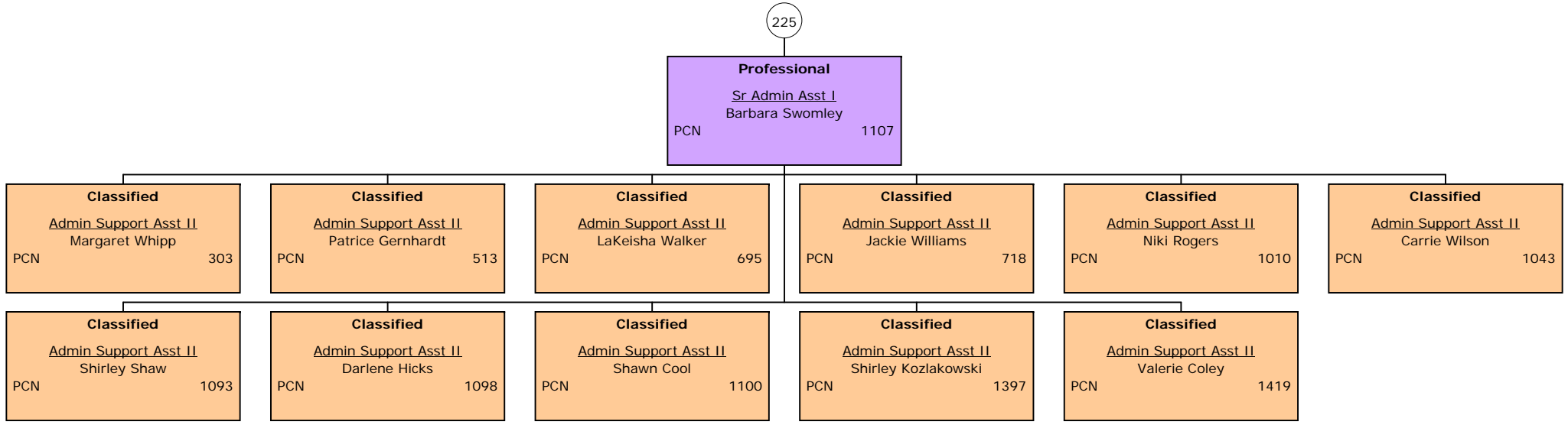

Organizational Chart FY 2017

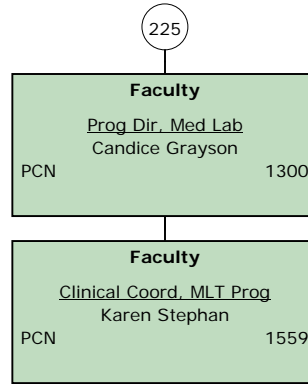

Organizational Chart FY 2017

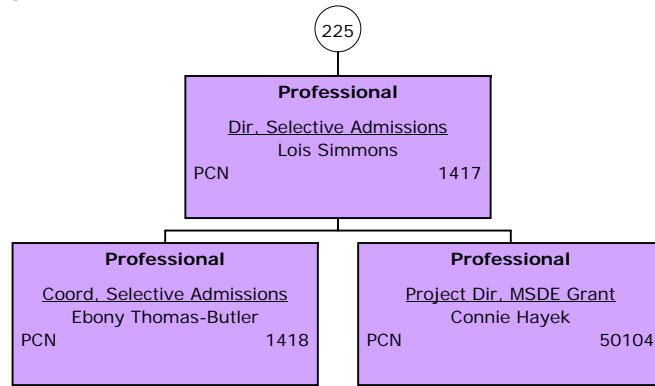

Organizational Chart FY 2017

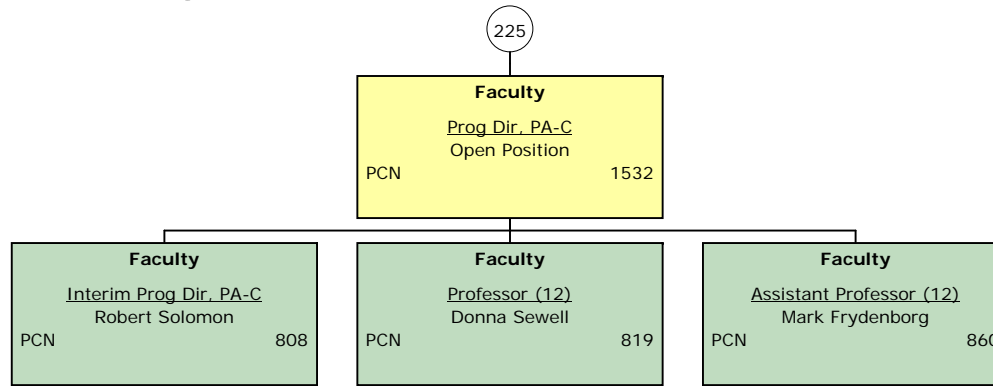

Organizational Chart FY 2017

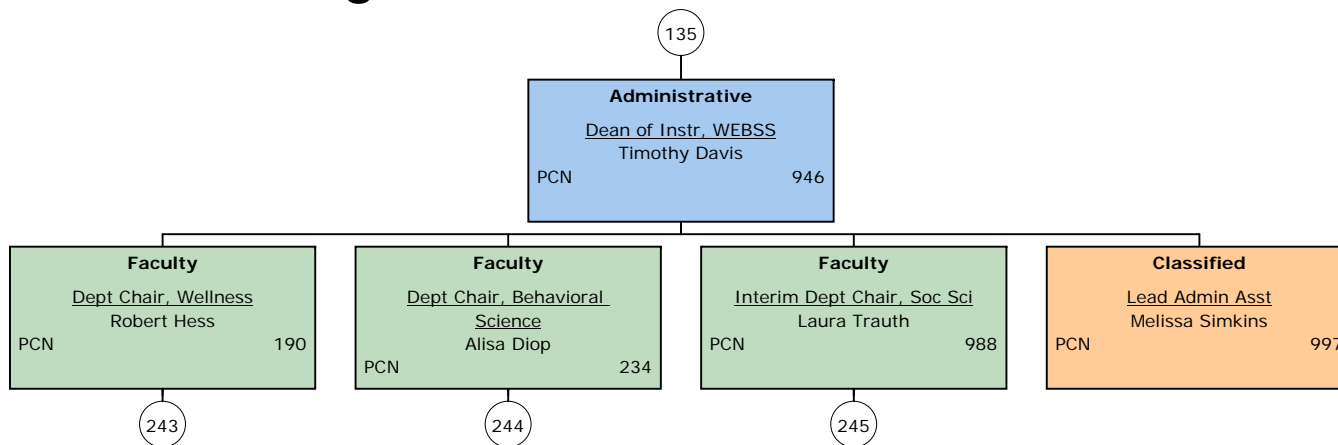

Organizational Chart FY 2017

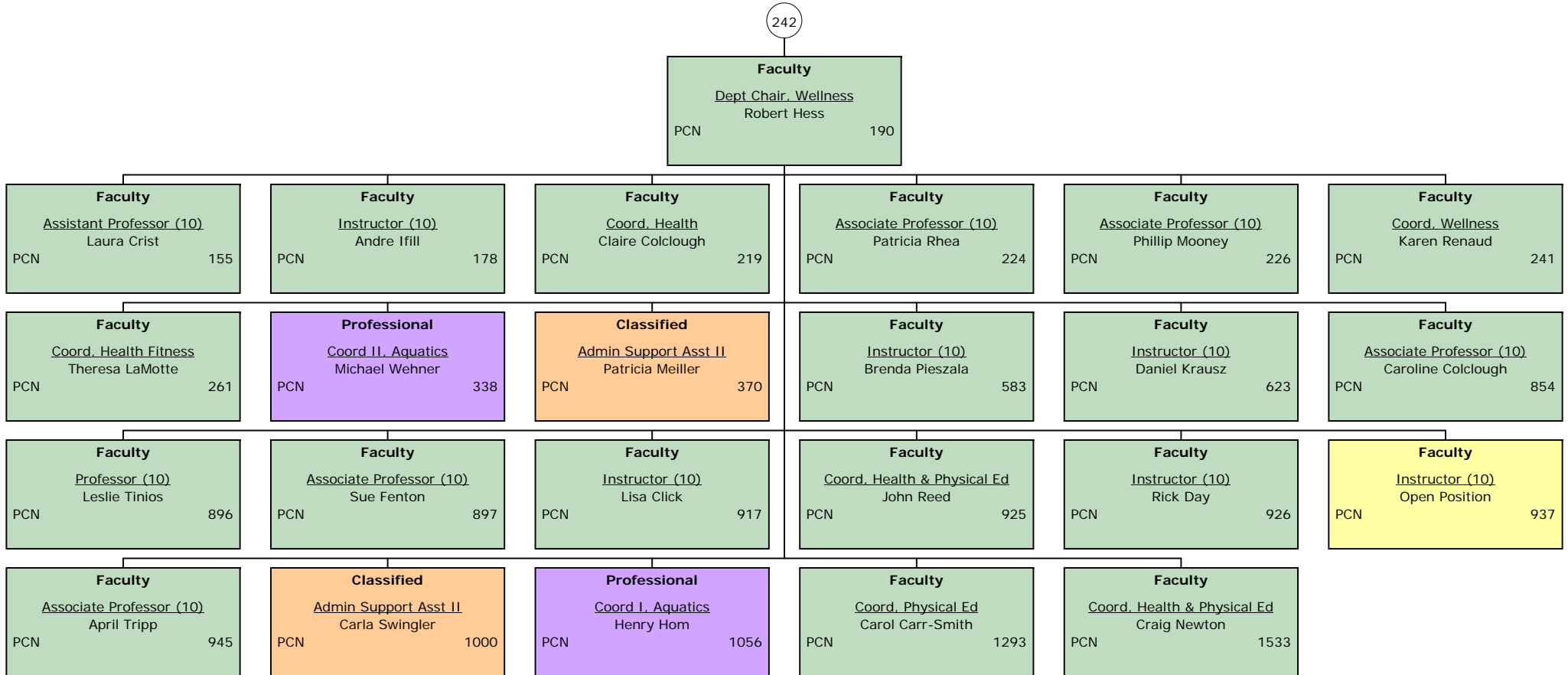

Organizational Chart FY 2017

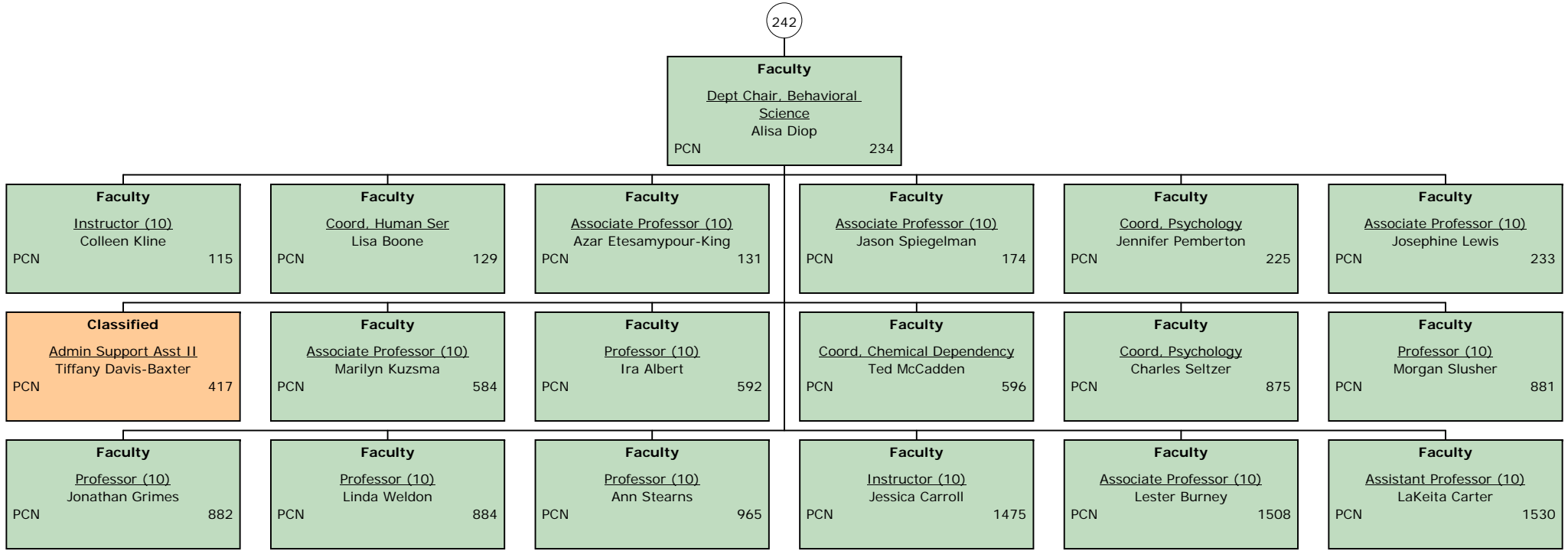

Organizational Chart FY 2017

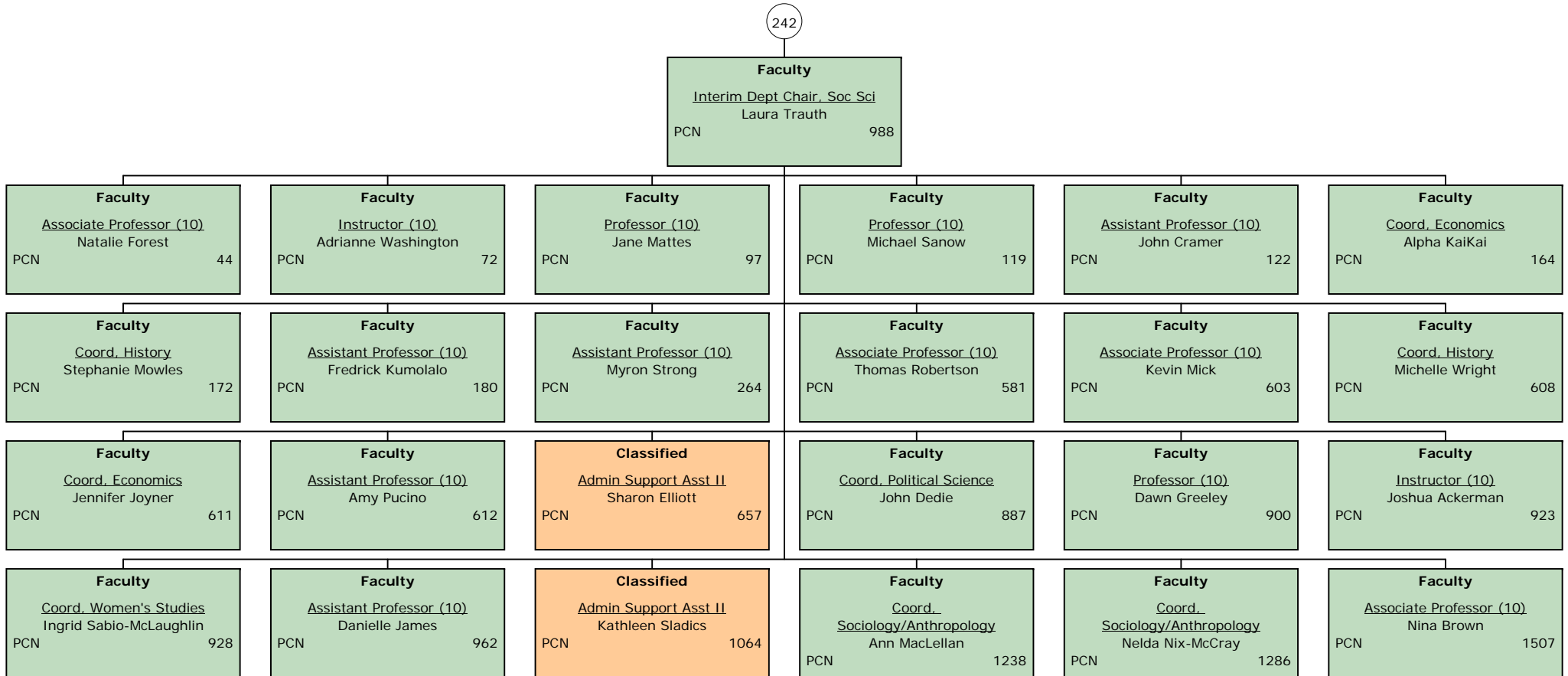

Organizational Chart FY 2017

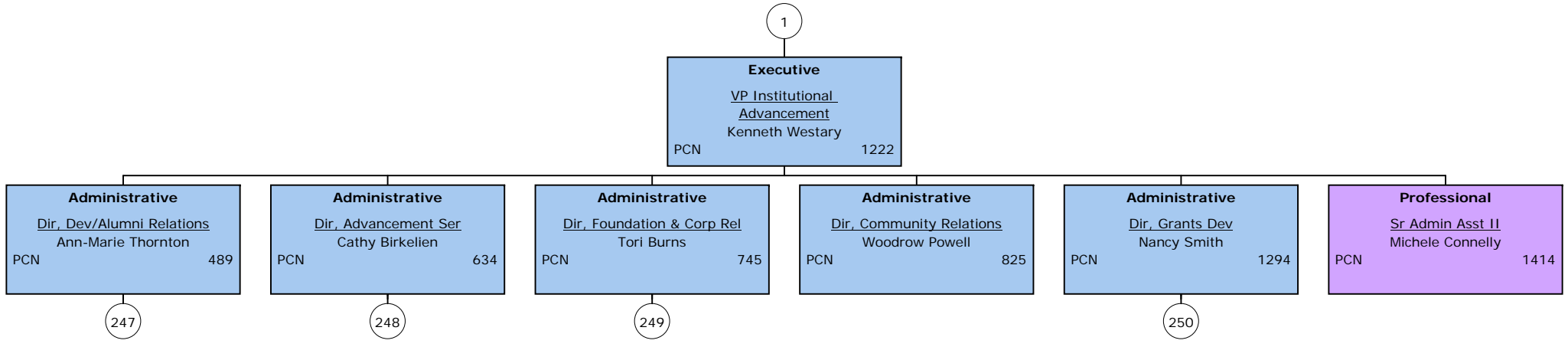

Organizational Chart FY 2017

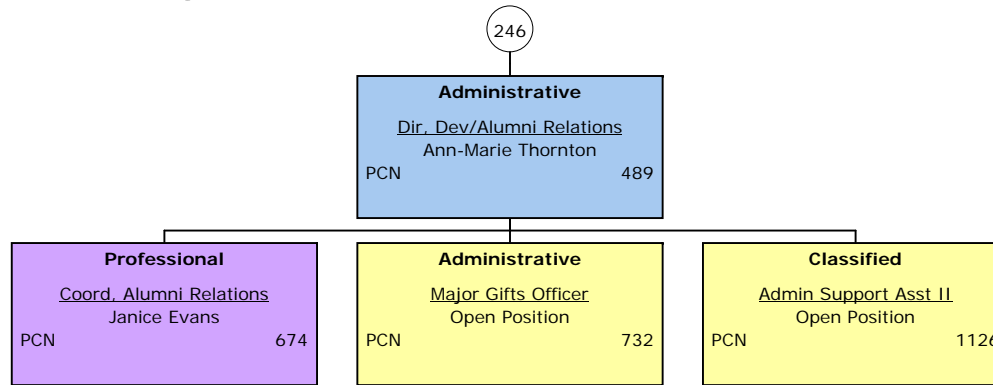

Organizational Chart FY 2017

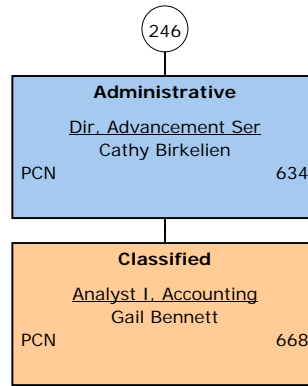

Organizational Chart FY 2017

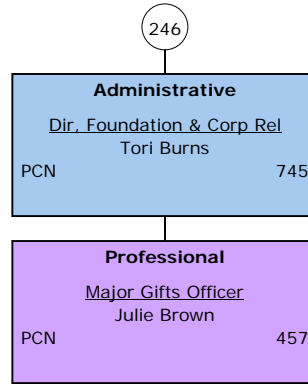

Organizational Chart FY 2017

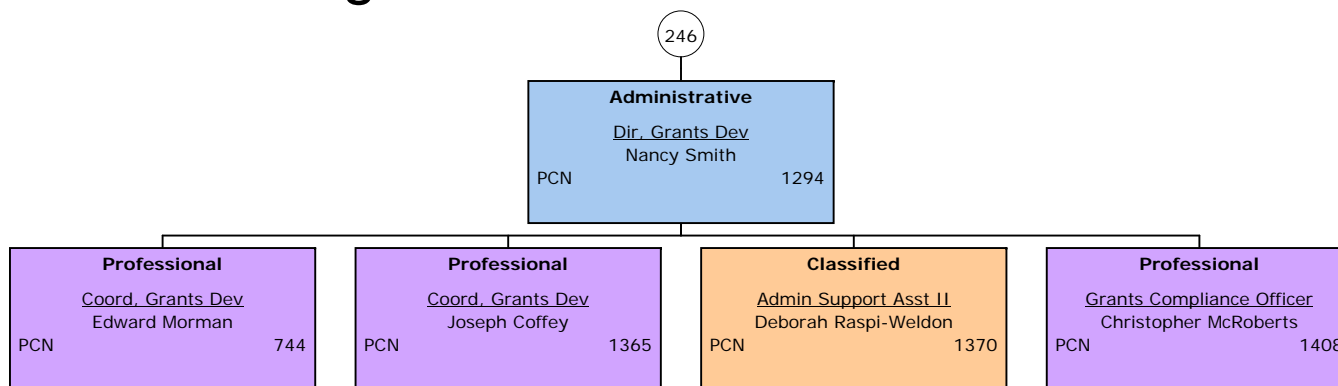

Name:	Job Title:	Box Title:	PCN	Page #
Dina Abkairova	Asst Counselor, Intl St	Professional	1201	117
Todd Abramovitz	Professor (10)	Faculty	1389	138
Sarah Abromaitis	Assistant Professor (10)	Faculty	893	148
Joshua Ackerman	Instructor (10)	Faculty	923	245
Thomas Adams	Groundskeeper	Unit One	13	54
Shawntaye Adams	Assistant Professor (10)	Faculty	137	145
Joy Adams	Coord, Dev Education	Professional	1433	222
Daniel Adams	Library Tech III, Library Tech	Classified	413	221
Adjowa Adantor	Custodian I	Unit One	1412	68
Charese Adesalu	Interim Dir, Accounting	Professional	704	28
Oroboghene Adia	Web Developer	Professional	1378	94
Toni Aho	Asst Dir, Leadership/Civic Eng	Professional	1084	81
Jessica Aladetohun	Tech, Enrollment Ser	Classified	1087	129
Valerie Albaugh	Specialist II, Bookstore	Classified	1472	24
Ira Albert	Professor (10)	Faculty	592	244
Muhammad Alharmosh	Certified PSO	Classified	1519	43
Drucilla Allen	Catalog Librarian	Faculty	1083	220
William Allewalt	Supervisor, Athletic Facilities	Classified	425	76
Anthony Alleyne	Admin, St Conduct	Professional	75	80
Troy Alliman	Custodian I	Unit One	1053	73
Sharnita Alston	Certified PSO	Classified	1545	43
Stephaughn Alston	Custodian I	Unit One	803	68
Jaime Alvarez	Campus Dir	Administrative	822	39
Cohen Ambrose	Assistant Professor (10)	Faculty	222	204
Rhonda Amenu-El	Assistant Professor (10)	Faculty	41	204
Ronald Amesbury	Specialist, Instr Support	Classified	287	19
Areathia Amos	Custodian I	Unit One	39	69
Barry Amos	Asst Dir, Financial Aid	Administrative	738	125
Evelyn Amtmann	General Ser Tech II	Unit One	785	52
Rachel Anderson	Admin Support Asst II	Classified	1080	120
Kristine Anderson	Sr Dir, Instr Tech	Administrative	736	15
Lindsey Anderson	Dir, Community Collab Prog	Administrative	80041	173
Robin Anderson	Prog Dir, Massage Therapy	Faculty	826	231
Darlene Anderson	Admin, Eval&Reverse Trans Ser	Administrative	86	128
Robert Anson	Associate Professor (10)	Faculty	859	156
Jenna Antos	Specialist, Fiscal Support	Classified	314	90

Organizational Chart FY 2017

Date: 10/25/2016

Name:	Job Title:	Box Title:	PCN	Page #
Sabum Anyangwe	Coord, Cyber Security	Faculty	1399	142
Richard Argue	Bldg & Maint Tech I	Unit One	24	58
Beth Arman	Dir, Instr Proj & Initiatives	Administrative	566	200
Sandy Armstrong	Accountant II	Classified	394	28
Kathryn Arnold	Specialist II, Scheduling	Classified	419	127
Iris Arroyo	Specialist III, Enrollment Ser	Classified	694	132
Lois Artes	Lead Lab Tech	Classified	1066	154
Jean Ashby	Dean of Instr, SOMS	Administrative	88	143
James Ashley	Utility Engineer I	Unit One	771	62
Joyce Ashlock	Admin Support Asst II	Classified	50033	184
Kambiz Askarpour	Assistant Professor (10)	Faculty	953	148
Teresa Audia	Admin Support Asst II	Classified	1506	45
Abdellahi Aw	Assistant Professor (10)	Faculty	69	146
Leslie Ayella	Admin, IT Training	Professional	364	181
Bunmi Babarinde Hall	Admin, Digital & Emerging Tech	Professional	1205	16
Harold Babb	Coord, Auto GM	Faculty	64	140
Anjili Babbar	Assistant Professor (10)	Faculty	260	205
Shelly Badders	Coord, Credit Contracts	Professional	1463	173
Tim Bageant	Utility Engineer I	Unit One	1214	58
Elaine Bagley	Specialist I, Billing	Classified	677	191
Arthur Bailey	Supervisor, Grounds	Classified	550	51
Nicole Baird	Dean, St Dev	Administrative	747	96
Monta Baird	Specialist II, Financial Aid	Classified	993	126
Brooke Baker	Specialist I, Enrollment Ser	Classified	1033	134
Jenny Baker	Admin Support Asst III	Classified	1104	217
Barbara Baker	Admin Support Asst II	Classified	1115	197
Wendy Baker	Admin, PR Benefits & Taxes	Professional	285	33
Debra Baker	Asst Registrar	Administrative	324	129
Van Baker	Lab Tech III	Classified	429	138
Evan Balkan	Coord, English	Faculty	191	205
Knicky Balson Dreyer	Admin Support Asst III	Classified	421	155
Clarence Baney	Assistant Professor (10)	Faculty	1513	148
Linda Bange	Academic Advisor	Professional	466	111
Kathy Baranoski	Assistant Professor (10)	Faculty	1514	148
Johari Barnes	Dir, Academic Support	Administrative	1431	222
Richard Barnett	Specialist II, Bookstore	Classified	1081	25

Organizational Chart FY 2017

Date: 10/25/2016

Name:	Job Title:	Box Title:	PCN	Page #
Sarah Barnhardt	Associate Professor (10)	Faculty	1229	202
Tom Barrett	Coord, CADD	Faculty	107	139
Caroline-Anne Barringer	Dir, Children's Learning Ctr	Professional	532	83
Heidi Barth	Analyst, Research & Planning	Professional	761	48
Fred Bartlett Jr	Coord, CSIT	Faculty	511	141
Kyeshea Bashir	Admin, Training	Professional	1440	46
Mary Battaglia	Specialist II, Payroll	Classified	1009	33
Tami Batton	Specialist II, Bookstore	Classified	1132	25
David Baum	Assistant Professor (10)	Faculty	182	152
Beth Baunoch	Coord, Mass Comm	Faculty	1529	203
Matthew Baxley	Groundskeeper	Unit One	783	51
Phyllis Baytop	Professor (10)	Faculty	235	159
Mary Beach	Lead Admin Asst	Classified	717	96
Mike Bean	Sr Network Engineer	Professional	764	14
Ellen Beattie	Coord, Adult Basic Ed Prog	Professional	50005	186
Tonya Beatty	Clinical Coord, Dental Hygiene	Faculty	899	228
Kristen Beck	Dir, St Finance	Administrative	1156	35
Bernadette Becker	Coord, St Success Ctr	Professional	248	223
Gayona Beckford-Barclay	Coord, Business Studies	Faculty	848	160
Denine Beckmann	Specialist II, Payroll	Classified	729	33
Samuel Beeghley	Capital Project Mgr	Professional	1444	65
Andrew Beiderman	Associate Professor (10)	Faculty	990	148
John Belbeck Jr	Utility Engineer I	Unit One	14	58
Jaime Bell	Asst Dir, St Ser	Administrative	1422	111
Diane Benedetta	Specialist II, Bookstore Accts	Classified	1072	25
Jessica Benedict	Specialist III, Operations	Classified	427	167
Danielle Bennett	Admin Support Asst III	Classified	1313	192
Gail Bennett	Analyst I, Accounting	Classified	668	248
Andie Benton	Specialist II, Scheduling	Classified	328	127
Matthew Bernardy	Dir, Connections to Employment	Administrative	1210	181
Melvin Berry	Assistant Professor (10)	Faculty	147	205
Gaynele Bess	Admin Support Asst II	Classified	675	138
Inicia Best	Asst Dir, Payroll	Professional	710	33
Sharon Bethea	Custodian I	Unit One	788	73
Cathy Birkelien	Dir, Advancement Ser	Administrative	634	248
Chris Bishop	Utility Engineer I	Unit One	1281	58

Name:	Job Title:	Box Title:	PCN	Page #
Bonnie Black	Academic Advisor	Professional	1152	110
Annjeannette Black	Admin Support Asst II	Classified	375	152
Maxim Blackford	Veh Equipment Mech I	Unit One	270	64
Kim Bleakley	Designer, Publications	Classified	327	92
Melinda Blomquist	Associate Professor (10)	Faculty	921	204
Camelia Blue	Admin, Career Search	Professional	78027	176
Judy Blum	Assistant Dean of Instr, SOHP	Administrative	560	228
Lorri Bocklage	Admin Support Asst II	Classified	1091	189
Lisa Boeren	Specialist II, Theatre	Classified	1106	208
Nancy Bogage	Associate Professor (10)	Faculty	871	141
Jean Boggs	Reference/Instr Librarian	Faculty	641	216
Brooke Bognanni	Dept Chair, English	Faculty	885	205
Kim Bolling	Programmer/Analyst	Professional	1178	13
Theresa Bonvegna	Academic Advisor	Professional	1571	109
Lisa Boone	Coord, Human Ser	Faculty	129	244
Terri Booth	Admin Support Asst II	Classified	313	76
Lynnea Booth	Admin Support Asst II	Classified	540	207
Donald Bortner	Dir, Owings Mills Ctr	Administrative	1493	172
Jay Bouis	Dir, Tech Training	Administrative	506	193
John Bowen	Assistant Professor (10)	Faculty	168	160
Michael Bowman	Certified PSO	Classified	1071	43
Osen Bowser	Assistant Professor (10)	Faculty	610	205
Sharon Boyd	Custodian I	Unit One	1406	69
Larry Boyd	Admin, Career Search	Professional	78034	177
Artraelle Boyette-Kelly	Assistant Professor (12)	Faculty	103	137
Judith Boyle	Assistant Professor (10)	Faculty	1566	226
Willa Boze	Associate Professor (10)	Faculty	609	141
James Braman	Coord, CSIT	Faculty	1277	141
Sheila Brandenburg	Sr Admin Asst II	Professional	431	1
Kelli Brandjes	Admin Support Asst II	Classified	996	207
Rudolph Brathwaite	Assistant Professor (10)	Faculty	1279	205
Trevor Bratton	Specialist II, Enrollment Ser	Classified	1427	168
Paige Brewton	Admin, Career Search	Professional	78031	177
Stephanie Briggs	Assistant Professor (10)	Faculty	185	205
Nathan Brigham	Multimedia Designer	Professional	468	90
Iris Bronson-Sorrell	Custodian I	Unit One	787	73

Organizational Chart FY 2017

Date: 10/25/2016

Name:	Job Title:	Box Title:	PCN	Page #
Maria Brooks	Custodian I	Unit One	801	73
Linda Brothers	Career Counselor	Professional	1174	102
Charles Brown	Analyst I, Help Desk	Classified	1042	10
Alison Brown	Dir, Benefits	Administrative	1254	47
Dorothy Brown	Specialist II, St Accts	Classified	1261	38
Jim Brown	Analyst I, Help Desk	Classified	1329	10
Nina Brown	Associate Professor (10)	Faculty	1507	245
John Brown	Custodian I	Unit One	18	69
Chanda Brown	Admin, Financial Aid	Professional	348	123
Julie Brown	Major Gifts Officer	Professional	457	249
Lisa Brown	Assistant Professor (10)	Faculty	865	148
Robert Brown	Coord, Mathematics	Faculty	880	147
Jessica Brown-Strott	Instructor (10)	Faculty	1332	159
Kate Bruce	Specialist II, Operations	Classified	78058	176
Michael Buchwald	Interim Supervisor, Bldg Ser	Unit One	769	70
Kenneth Buck	Dir, Randallstown Ctr	Administrative	498	165
Nicole Buckingham Kern	Coord, Art Gallery	Professional	725	138
Lorrie Budd	Asst Dir, St Life	Professional	1465	81
Warren Bullard	Analyst III, Help Desk	Classified	439	10
Jacqueline Bullard	Admin Support Asst III	Classified	640	174
Peter Bullock	Analyst II, Help Desk	Classified	1235	8
Timothy Bumar	Admin, LMS	Professional	646	16
Yvette Bunn Jones	Dir, Emp Rel, Training & OD	Administrative	1225	46
Susan Bunting	Mgr, Nursing Lab	Faculty	1425	232
Jill Burke	Reference/Instr Librarian	Faculty	106	217
Brian Burke	Prog Dir, Mortuary Science	Faculty	220	227
Tom Burkett	Professor (10)	Faculty	153	155
Clarence Burney	Specialist I, Enrollment Ser	Classified	1124	130
Lester Burney	Associate Professor (10)	Faculty	1508	244
Tori Burns	Dir, Foundation & Corp Rel	Administrative	745	249
Timothy Burton	Interim Exec Dir, Fac Mgt	Professional	1489	49
Anita Burton	Admin Support Asst II	Classified	343	140
Patricia Butcher	Custodian I	Unit One	7	68
Wayne Butler	Certified PSO	Classified	274	41
Verginia Butoi-Varga	Career Team Leader	Professional	78022	176
Maria Buttion	Admin Support Asst II	Classified	595	199

Organizational Chart FY 2017

Date: 10/25/2016

Name:	Job Title:	Box Title:	PCN	Page #
Melinda Bynog	Coord, Sr Education	Professional	1150	178
Carol Byrd	Library Tech II, Tech Ser	Classified	365	214
Jennifer Cabana	Admin Support Asst II	Classified	635	180
Merri Cage	Dir, Children's Learning Ctr	Professional	1162	87
Arthur Cage	Assistant Professor (10)	Faculty	586	152
Marla Cain	Office Asst	Classified	450	207
Myron Campbell	Analyst II, Help Desk	Classified	1047	10
Jacqueline Campbell	Admin, Career Search	Professional	78026	177
Gregory Campbell	Assistant Professor (10)	Faculty	843	205
Jeremy Caplan	Assistant Professor (10)	Faculty	1168	203
Andrea Capps	Admin Support Asst II	Classified	356	171
Dennis Cardiff	Dir, Con Ed St Success	Administrative	1191	164
Cristina Cardona	Instructor (10)	Faculty	126	150
Michael Carey	Exec Dean, Con Ed & Econ Dev	Administrative	531	163
Brenda Caroline	Specialist II, Enrollment Ser	Classified	299	130
Kristin Carpenter	Certified PSO	Classified	972	43
Theresa Carr	Interim Dean, St Ser, Enr Mgt	Administrative	1166	113
Jessica Carroll	Instructor (10)	Faculty	1475	244
Justin Carroll	Certified PSO	Classified	1518	41
Carol Carr-Smith	Coord, Physical Ed	Faculty	1293	243
LaKeita Carter	Assistant Professor (10)	Faculty	1530	244
Priscella Carter-Thomas	Benefits Asst	Classified	435	44
Peter Carver	Assistant Professor (10)	Faculty	872	203
Greg Case	Coord, Construction Mgt	Faculty	95	139
John Casey	Assistant Professor (10)	Faculty	124	205
Sharon Casey	Instr Librarian	Faculty	568	216
Charlyn Cassady	Professor (10)	Faculty	955	202
Chris Chalker	Coord, Tech Training	Professional	1409	195
Anne Chamberlain	Coord, Comm Studies	Faculty	1318	203
Louise Chan	Sr Academic Advisor	Professional	62	109
John Chandler	Assistant Professor (10)	Faculty	1377	138
Jennifer Chase	Sr Academic Advisor	Professional	99	109
Calvin Chase	Specialist, Accts Payable	Classified	994	29
Mary Louise Cheicante	Library Tech II, Tech Ser	Classified	1062	218
Emilie Cherry	Dir, HS Collaboration	Professional	50041	211
James Chesnut Jr	Reference/Instr Librarian	Faculty	1196	212

Name:	Job Title:	Box Title:	PCN	Page #
Annmarie Chiarini	Assistant Professor (10)	Faculty	878	205
Wendy Chin	Assistant Professor (10)	Faculty	938	141
Sheila Christmas	Library Tech II, Public Ser	Classified	422	215
Kathy Christopher	Admin Support Asst II	Classified	50001	183
Deborah Ciccarelli	Coord, Arts	Faculty	128	138
Pat Cihlar	Admin Support Asst II	Classified	713	114
Bernice Clark	Admin Support Asst III	Classified	1001	127
MJ Clark	Assistant Professor (10)	Faculty	1534	151
Kadriyya Clark	Associate Professor (12)	Faculty	297	226
Kerry Cleaver	Coord, Health & Human Ser	Professional	490	199
David Clements	Instructor (10)	Faculty	163	160
Natasha Clements	Admin, Career Search	Professional	78032	177
Michele Clements	Coord, CSIT	Faculty	842	141
Thomas Clemons	Certified Sergeant	Classified	527	41
Lisa Click	Instructor (10)	Faculty	917	243
Virginio Clinedinst	Groundskeeper	Unit One	553	64
Charlton Coates	Custodian I	Unit One	80051	69
Joseph Coffey	Coord, Grants Dev	Professional	1365	250
Claire Colclough	Coord, Health	Faculty	219	243
Caroline Colclough	Associate Professor (10)	Faculty	854	243
Gwendolyn Cole	Instr Specialist I	Professional	78050	193
Natasha Cole-Leonard	Assistant Professor (10)	Faculty	558	205
Stacey Coles	Specialist II, Call Ctr	Classified	437	114
Valerie Coley	Admin Support Asst II	Classified	1419	238
John Colmes Jr	Mgr, Building Ser	Professional	20	67
Thomas Colonna	Professor (10)	Faculty	607	204
Paulette Comet	Associate Professor (10)	Faculty	1285	141
Brandy Commander	Instructor (10)	Faculty	920	226
Brian Comotto	Assistant Professor (10)	Faculty	869	204
Eugene Conaway	Custodian I	Unit One	1405	68
Sarada Conaway	Associate Professor (10)	Faculty	851	138
Moe Conn	Technical Dir	Professional	412	208
Michele Connelly	Sr Admin Asst II	Professional	1414	246
Michael Connelly	Certified Corporal	Classified	979	43
Shawn Cool	Admin Support Asst II	Classified	1100	238
Florence Cooney	Counselor, Disability Support	Faculty	266	112

Name:	Job Title:	Box Title:	PCN	Page #
Charlene Cooper	Dir, Enrollment Ser	Administrative	1544	131
Kimberly Cooper	Library Tech II, Public Ser	Classified	411	212
Barb Cooper	Specialist, Purchasing	Classified	658	31
Curtiss Cooper	Lab Tech III	Classified	703	156
Nickie Copinger	Analyst II, Purchasing	Classified	720	31
Hoa Cost	Associate Professor (10)	Faculty	838	150
Alexis Cotay III	Assistant Professor (10)	Faculty	157	148
Eric Cotton	Assistant Professor (10)	Faculty	1492	152
Zolita Courter	Admin Support Asst II	Classified	691	207
Christopher Covington	Certified PSO	Classified	273	41
Jessica Craddock	Specialist I, Enrollment Ser	Classified	1426	132
Cheri Craft	Dir, Budget	Administrative	811	34
John Cramer	Assistant Professor (10)	Faculty	122	245
Rosemarie Cramer	Dept Chair, Business Studies	Faculty	245	160
Barbara Crawford	Assistant Professor (10)	Faculty	194	205
Robert Creamer	Associate Professor (10)	Faculty	943	138
Matthew Crisp	Specialist III, Enrollment Ser	Classified	1416	132
Laura Crist	Assistant Professor (10)	Faculty	155	243
Keith Crook	General Ser Tech I	Unit One	35	55
Trina Crook	Dir, Capital Finance	Administrative	737	26
Shawn Crosby	Instr Designer	Professional	351	18
Darlene Cross	Associate Professor (10)	Faculty	1512	141
Patti Crossman	Dept Chair, Perf Arts/Hum	Faculty	606	204
Xianghao Cui	Associate Professor (10)	Faculty	939	148
Sarah Cullip	Admin Support Asst II	Classified	1030	196
Heather Currey	Dir, Con Ed Sys, Cust Ser, Res	Administrative	559	166
Jacqueline Cymek	Specialist III, Financial Aid	Classified	1443	126
Jennifer Dagostin	Asst Dir, Admissions	Administrative	1295	120
Karen Dalton	Coord, Biology	Faculty	206	155
Richard D'Ambrisi	Instr Specialist II	Professional	78047	199
Noell Damron	Dept Chair Networking/Security	Faculty	940	142
Stanjay Daniels	Instructor (10)	Faculty	516	232
Diane Darchicourt	Specialist III, Enrollment Ser	Classified	1219	129
Josette Darden-Obi	Associate Professor (10)	Faculty	1385	205
Trish Darr	Interim Dir, Testing Ctrs	Professional	1051	105
Beverley Davidson	Instr Specialist II	Professional	78046	199

Name:	Job Title:	Box Title:	PCN	Page #
John Davis III	Associate Professor (12)	Faculty	67	140
Hope Davis	Dir, Media Relations	Administrative	1266	95
Steven Davis	Groundskeeper	Unit One	1435	51
Ryan Davis	Certified PSO	Classified	765	43
Timothy Davis	Dean of Instr, WEBSS	Administrative	946	242
Tiffany Davis-Baxter	Admin Support Asst II	Classified	417	244
Roderick Day	Certified PSO	Classified	1517	41
Rick Day	Instructor (10)	Faculty	926	243
Linda De La Ysla	Associate Professor (10)	Faculty	223	205
Rebekah de Wit	Coord, ESOL	Faculty	1240	202
James DeAngelis	Coord, Auto Collision	Faculty	68	140
John Dedie	Coord, Political Science	Faculty	887	245
Gwyn Degner	Sr Academic Advisor	Professional	1540	110
Robert Del Prete Jr.	Custodian I	Unit One	536	70
Bill Delauder	Asst Dir, Facility Operations	Administrative	482	50
Rachael DeLauder	Advisor, tSTEM	Professional	50116	149
Janet Delgavio	Admin Support Asst II	Classified	1045	207
Susan Delker	Dept Chair, Academic Dev	Faculty	574	211
Norma DeLong	Admin Support Asst II	Classified	1068	222
Mary DeLuca	Sr Dir, College Comm	Administrative	739	89
Mary Kay DeMarco	Campus Dir, Nursing	Faculty	814	232
Christine DeStefano	Dept Chair, Biology	Faculty	912	154
Anita Dewling	Job Developer	Professional	78020	177
Deborah Dews	Career Team Leader	Professional	78025	177
Shakuntala Dhanesar	Campus Head Librarian	Faculty	573	216
Stacy DiBartolomeo	Clinical Coord, Radiography	Faculty	995	236
Erica DiCara	Coord, Physical Science	Faculty	193	152
Lori Dickens	Specialist II, Scheduling	Classified	1027	127
Desra Dickerson	Systems Engineer	Professional	383	14
Yvette Dickson-Webb	Library Tech II, Public Ser	Classified	633	216
Wade Dillon III	Custodian I	Unit One	780	73
Alisa Diop	Dept Chair, Behavioral Science	Faculty	234	244
Janice DiPietrantonio	Custodian I	Unit One	1556	73
Robert Dixon	Instr Specialist I	Professional	1239	192
Tammy Dixon	Specialist III, Enrollment Ser	Classified	699	168
Tim Dobrowolsky	Sr Systems Engineer	Professional	494	13

Organizational Chart FY 2017

Date: 10/25/2016

Name:	Job Title:	Box Title:	PCN	Page #
Dallas Dolan	Dir, Teaching & Learning Ctr	Faculty	662	209
Carolyn Doll	Specialist II, Enrollment Ser	Classified	1348	168
Susan Dominczak	Custodian I	Unit One	1549	71
Diane Donaldson	Instructor (12)	Faculty	221	227
Joan Donati	Lead Library Tech, Public Ser	Classified	708	217
Ryan Donnelly	Assistant Professor (10)	Faculty	512	205
Elaine Donoghue	Admin Support Asst III	Classified	650	22
Lalitha Dorai	Assistant Professor (10)	Faculty	956	150
Danielle Dorsey	Lead Custodian I	Unit One	800	72
Adrienne Dougherty	Prog Dir, Radiation Therapy	Faculty	823	233
Diane Drake	Dir, Admissions	Administrative	452	115
Kenneth Drummond	Custodian I	Unit One	1213	72
Stephen Drummond	Dir, Public Safety	Administrative	967	40
Kristin Duckworth	Coord, Mathematics	Faculty	142	145
Tracy DuCoty	Specialist II, Bookstore Accts	Classified	692	23
Tracey Duggan	Admin, Financial Aid	Professional	409	125
Patricia Dugger	Athletic Specialist	Unit One	670	78
Christina Duncan	Dir, Veteran Ser	Administrative	367	75
Stacey Dunnigan	Accountant III	Classified	1029	28
Fawcett Dunstan	Associate Professor (10)	Faculty	901	205
Amber Duvall	Specialist I, Financial Aid	Classified	1102	126
Pankaj Dwarka	Associate Professor (10)	Faculty	835	145
LaTonya Dyett	Coord, Academic Literacy	Faculty	624	202
Jessica Eck-Elliott	Instructor (10)	Faculty	1287	232
Scott Eckhardt	Dir, St Conduct & Title IX	Administrative	735	80
Josephine Edebe	Receptionist/Office Asst	Classified	1067	46
Stephan Edmonston	Dir, Sr Prog	Administrative	495	178
Gary Edsall	Mgr, Printing Ser	Administrative	666	91
Laura Edwards	Admin Support Asst II	Classified	1006	102
Sherron Edwards	Dir, Upward Bound	Professional	50015	99
Michael Ehrlinger	Professor (10)	Faculty	184	139
Joseph Eichelberger	Assistant Professor (10)	Faculty	1017	140
Marianne Eichenberger	Professor (10)	Faculty	935	232
Pamela Ekpe	Admin Support Asst I	Classified	1035	43
Dawan El-Amin	Academic Coord/Counselor	Professional	50016	98
Don Elliott	Dir, Con Ed Ops/OL Learning	Administrative	1372	170

Name:	Job Title:	Box Title:	PCN	Page #
Sharon Elliott	Admin Support Asst II	Classified	657	245
Tina Ellis	Custodian I	Unit One	1558	73
Michael Elspas	Asst Dir, Creative Ser	Professional	715	92
Marc Ershler	Asst Dir, College Athletics	Administrative	758	78
Azar Etesampour-King	Associate Professor (10)	Faculty	131	244
William Eubert	Bldg & Maint Tech I	Unit One	27	62
Renee Eugene	Instructor (10)	Faculty	203	226
Beverly Eurice	Admin, Financial Aid	Professional	1078	126
David Evans	Athletic Specialist	Unit One	1069	79
Berdina Evans	Custodian I	Unit One	1411	73
Hayley Evans	Instr Aide II	Classified	310	140
Janice Evans	Coord, Alumni Relations	Professional	674	247
Shirley Everhart	Admin Support Asst II	Classified	1058	207
Kayla Ewart	Assistant Professor (10)	Faculty	149	146
Crissy Fabiszak	Asst Dir, St Life	Administrative	749	84
Lesley Fagu	Interim Asst Dir, St Ser	Professional	101	108
Timothy Faith	Assistant Professor (10)	Faculty	229	162
James Falcon	Dir, Con Ed Call & Info Ctr	Administrative	1319	168
Penny Fanzone	Professor (10)	Faculty	1299	141
Maurice Farley	Custodian I	Unit One	1553	68
Valerie Farmer	Assistant Professor (10)	Faculty	140	141
Brian Farrell	Dir, College Athletics	Administrative	557	76
James Fasching	Costumer	Professional	1127	208
Mary Feehley	Admin Support Asst II	Classified	709	108
Lisa Feinman	Assistant Professor (10)	Faculty	74	145
JoAnn Felder-Brown	General Ser Clerk	Unit One	1223	63
Nicholas Feldman	Analyst I, Help Desk	Classified	304	8
Tashauna Felix	Assistant Professor (10)	Faculty	961	154
Donald Felty	General Ser Clerk	Unit One	548	63
Sue Fenton	Associate Professor (10)	Faculty	897	243
Patricia Ferraris O'Neill	Professor (10)	Faculty	1505	162
Patricia Ferrell	Custodian I	Unit One	781	73
Kim Fink	Specialist I, Accts Rec	Classified	1255	37
Frances Finley	Assistant Professor (10)	Faculty	244	226
Amy Flagler	Instr Specialist II	Professional	60	199
Linda Fleischer	Dept Chair, Criminal Justice	Faculty	183	158

Name:	Job Title:	Box Title:	PCN	Page #
Charquese Fletcher	Admin, Financial Aid	Professional	349	123
Joan Florrow	Assistant Professor (10)	Faculty	916	232
Jessica Floyd	Assistant Professor (10)	Faculty	1188	205
Jerry Foehrkolb Sr	Analyst III, Help Desk	Classified	653	9
Evon Ford	Assistant Professor (10)	Faculty	198	150
Natalie Forest	Associate Professor (10)	Faculty	44	245
David Forest	Analyst III, Help Desk	Classified	686	9
Virginia Forster	Clinical Coord, Resp Care	Faculty	617	237
Ashley Fortney	Child Care Teacher II	Classified	721	85
Heather Foss	Assistant Professor (10)	Faculty	171	202
Carole Foster	Specialist II, Enrollment Ser	Classified	1349	168
Kenya Foster	Counselor, Admissions	Professional	753	119
Donna Fowler	Admin Support Asst II	Classified	763	141
Richard Fowler	Groundskeeper	Unit One	797	54
Cathy Frantz	Programmer	Professional	509	13
Joan Freggens	Admin Support Asst II	Classified	1477	186
Carl Freundel	Professor (10)	Faculty	1324	203
David Frey	Coord, Tech Training	Professional	78015	193
Mark Frydenborg	Assistant Professor (12)	Faculty	860	241
Susan Gabriel	Associate Professor (10)	Faculty	1291	205
Joyce Galatolo	Lead Custodian I	Unit One	544	68
Coura Galiba	Lab Tech III	Classified	309	155
Jamey Gallagher	Assistant Professor (10)	Faculty	207	205
KL Gallop-Cook	Admin Support Asst III	Classified	428	131
Ann Gamble	Dir, University Collaborations	Professional	70011	210
Mary Jo Garcia-Brown	Associate Professor (10)	Faculty	577	205
Alexis Garcia-Brown	Instructor (10)	Faculty	80055	141
Eric Gardner	Certified PSO	Classified	1391	43
Juanita Garrett	Admin Support Asst II	Classified	1057	50
Alex Garrido	Assistant Professor (10)	Faculty	1510	202
Amanda Gassman	Assistant Professor (10)	Faculty	1515	145
Mark Gay	Asst Dir, Fin Aid/Vet Ser/Sys	Administrative	63	122
Susan Gebren	Admin Support Asst II	Classified	1095	82
Sue Geer	Specialist, Ent Desktop Config	Classified	1316	5
Wikita George	Specialist III, Eval/Trans Ser	Classified	1059	128
Rocco Geppi	Athletic Operations Asst	Classified	1060	76

Name:	Job Title:	Box Title:	PCN	Page #
Patrice Gernhardt	Admin Support Asst II	Classified	513	238
Nilotpal Ghosh	Associate Professor (10)	Faculty	204	145
Guillermo Gibens	Assistant Professor (10)	Faculty	263	203
Jacqueline Gibson	Admin Support Asst II	Classified	714	195
Ada Giles	Academic Coord/Counselor	Professional	50029	100
Gwen Gilinger	Associate Professor (10)	Faculty	914	154
Ayanna Gilliam	Certified PSO	Classified	1525	43
Paul Glasgow	Professor (10)	Faculty	249	138
David Gmbus	Academic Advisor	Professional	569	108
Steve Godack	Utility Engineer I	Unit One	1301	62
Kyle Goehner	Associate Professor (10)	Faculty	1345	202
Laurie Goette	Specialist II, Payroll	Classified	371	33
Kristin Goetz	Instructor (12)	Faculty	913	233
Cheryl Gordon	Mgr, Document Delivery	Professional	404	215
Mary Gore	Assistant Professor (10)	Faculty	879	148
Ewa Gorski	Professor (10)	Faculty	230	155
Michael Gould	Lab Tech III	Classified	728	154
Debra Graber	Coord, Med Office Asst	Faculty	1531	137
Sandra Grady	Associate Professor (10)	Faculty	169	205
Donesha Grant	Counselor, Admissions	Professional	246	118
Thomas Graul	Bldg & Maint Tech I	Unit One	775	62
Kathleen Graves	Admin Support Asst III	Classified	665	40
Nobi Gray	Specialist II, Operations	Classified	676	170
Candice Grayson	Prog Dir, Med Lab	Faculty	1300	239
Dawn Greeley	Professor (10)	Faculty	900	245
Mary Green	Specialist II, Billing	Classified	1264	191
Tyrone Green	Custodian I	Unit One	28	67
Tiffany Greene	Specialist I, St Accts	Classified	423	36
Dominique Green-Gladden	Specialist II, Call Ctr	Classified	1054	114
Laurie Gregg	Library Tech II, Tech Ser	Classified	444	214
Mary Greiner	Sr Admin Asst I	Professional	1129	207
Jennifer Grelak	Admin Support Asst II	Classified	380	80
Daniel Grice	Custodian I	Unit One	25	73
Brenda Grierson	Lead Custodian I	Unit One	503	67
Meisha Grimes	Coord, Legal Studies	Faculty	1218	162
Jonathan Grimes	Professor (10)	Faculty	882	244

Organizational Chart FY 2017

Date: 10/25/2016

Name:	Job Title:	Box Title:	PCN	Page #
Heather Griner	Dir, College & Comm Outreach	Professional	65	75
Peggysue Groft	Custodian I	Unit One	770	73
Linda Gronberg-Quinn	Dept Chair, Education	Faculty	215	159
Robin Grove	Analyst II, Data Support	Classified	347	127
Alonzo Grover Jr	Admin, Environment/Safety Comp	Professional	984	49
Jackie Guarente-Rider	Sr Programmer/Analyst	Professional	323	13
Ashley Gubosh	Supervisor, Operations	Professional	661	170
Marissa Gullion	Instructor (10)	Faculty	202	226
Janice Gunes	Sr Academic Advisor	Professional	813	109
Brian Gunn	Admin Support Asst II	Classified	449	207
Walter Gunter Jr	Certified PSO	Classified	1547	41
Manish Gururani	Sr Analyst, Financial Systems	Professional	1170	32
Jaya Gururani	Specialist I, St Accts	Classified	1441	37
Sylvia Gutowska	Assistant Professor (10)	Faculty	621	148
Jeanne Gyr	Advisor, Transition Prog	Professional	70012	210
Shelrae Hackey	Admin Support Asst II	Classified	359	138
Michelle Hackley	Counselor, Disability Support	Professional	502	112
Celena Hadlock	Instructor (10)	Faculty	852	202
Dell Hagan-Rhodes	Dir, St Life	Administrative	1197	81
Joy Halcott	Admin Support Asst II	Classified	276	49
Janet Hale	Coord, External Diploma Prog	Professional	50002	184
Louis Hall	Custodian I	Unit One	1245	73
Pauline Hamilton	Associate Professor (10)	Faculty	841	150
William Hammond IV	Coord, Health & Human Ser	Professional	391	199
Kwangsoo Han	Systems Librarian	Faculty	1283	221
Alexis Hance	Child Care Teacher II	Classified	426	83
Nancy Hance	Child Care Teacher II	Classified	445	83
Leah Hand	Library Tech II, Public Ser	Classified	1086	217
Melissa Hanks	Admin, Mobile/Innovative Tech	Professional	1247	19
Andrew Hanks	Bookstore Mgr	Administrative	398	24
Ben Hardy	Specialist, Instr Tech	Classified	438	19
Sheila Harrah	Custodian I	Unit One	1243	73
Patricia Harrigan	Associate Professor (10)	Faculty	464	202
Mark Harris Sr	Lab Tech I	Classified	1206	140
Jeanette Harris	Admin, Employment	Professional	1312	45
Heather Harris	Coord, English	Faculty	1509	205

Name:	Job Title:	Box Title:	PCN	Page #
Haleh Harris	Assistant Professor (10)	Faculty	1535	202
Jamie Harris	Coord, Intake/Assess (ESOL)	Professional	50101	183
Kevin Harris	Specialist I, St Accts	Classified	651	36
Lora Harris	General Ser Tech I	Unit One	777	52
Erika Harris	Campus Head Librarian	Faculty	927	217
Jamia Harris	Specialist I, Enrollment Ser	Classified	986	126
Mintra Harrybatchan-Sharma	Asst Dir, St Finance	Administrative	318	36
Madeline Hart	Career Counselor	Professional	1160	102
Pamela Hartke	Specialist I, Payroll	Classified	366	171
Cheryl Hawkins	Admin, Career Search	Professional	78033	176
Connie Hayek	Project Dir, MSDE Grant	Professional	50104	240
Sharon Hayes	Coord, Academic Literacy	Faculty	151	202
Tobylarue Haynes	Technical Trainer	Classified	1202	16
Cheryl Hazel	Dir, Project Start	Professional	50030	100
Robert Healy	Custodian I	Unit One	1014	71
Paul Heaney	General Ser Tech I	Unit One	4	55
Kathleen Hebbel	Interim Coord, Con Ed Bus Dev	Professional	1359	163
Harvey Heiserman	Coord, Auto Toyota	Faculty	89	140
William Hemling	Instructor (12)	Faculty	742	140
Tanya Hemmeian	Admin, Shared Ser Ctr	Professional	1031	130
Robert Henderson Jr	Prog Dir, EMT	Faculty	830	234
Hesham Henein	Sr. Academic Advisor	Professional	815	110
Brandy Henry	Dir, Bookstores	Administrative	680	23
Jennifer Herchenroeder	Instructor (12)	Faculty	50090	140
Christopher Herman	Sr Systems Engineer	Professional	471	14
James Hershey	Assistant Professor (10)	Faculty	929	154
Martha Hervey	Asst Dir, Academic Advisement	Administrative	1137	109
Robert Hess	Dept Chair, Wellness	Faculty	190	243
Jeffrey Hess	Associate Professor (10)	Faculty	863	235
David Hewitt	Assistant Professor (10)	Faculty	212	205
Darlene Hicks	Admin Support Asst II	Classified	1098	238
Valerie Hicks	Assistant Professor (10)	Faculty	903	202
Lynette Higgins	Dir, Business, Mgt, Comp & HIT	Administrative	731	196
Edward Hill	General Ser Tech II	Unit One	1020	52
Barbara Hill	Professor (10)	Faculty	1252	232
Maura Hill	Instructor (10)	Faculty	208	205

Name:	Job Title:	Box Title:	PCN	Page #
Anthony Hill	Custodian I	Unit One	32	69
Shieedah Hilton	Specialist I, Enrollment Ser	Classified	433	132
Ronald Hinkel	Dir, Cyber Security Inst	Administrative	50106	142
Margaret Hinkle	Instructor (12)	Faculty	469	228
Terry Hirsch	Sr Dir, PRE	Administrative	1195	48
Shirley Hobbs	Specialist I, Accts Rec	Classified	301	36
Robin Hoffman	Custodian I	Unit One	776	72
Jeremy Hoffmann	Instructor (12)	Faculty	52	142
Christiana Hoffmann	Lab Tech III	Classified	643	153
Danielle Holland	Assistant Professor (10)	Faculty	1251	159
Sherry Holland	Assistant Professor (10)	Faculty	239	226
Vernon Holley	Academic Coord/Counselor	Professional	50047	101
Sarah Holliday	Career Counselor	Professional	50097	102
Chaz Holloway	Certified PSO	Classified	975	42
Wanda Holmes-Smith	Custodian I	Unit One	768	73
Iris Holt	Specialist, Purchasing	Classified	706	31
Henry Hom	Coord I, Aquatics	Professional	1056	243
Susan Honeycutt	Specialist III, Enrollment Ser	Classified	1074	130
Vicki Hong-Smith	Assistant Professor (10)	Faculty	966	202
Andre Hood	Supervisor, Grounds	Classified	15	54
Melanie Hood-Wilson	Dir, Special Population Ser	Professional	748	180
Roy Hoopengardner	Lead Groundskeeper	Unit One	556	64
Janice Hopkins	Custodian I	Unit One	16	69
Melissa Hopp	VP Administrative Services	Executive	1189	2
Terry Horner	Admin Support Asst II	Classified	1108	116
Mary Horner	Admin, Grants	Professional	50058	225
Danielle Horney	Specialist III, Financial Aid	Classified	711	125
Debbie Horsey	Lead Admin Asst	Classified	400	143
Rune Horvik	Programmer/Analyst	Professional	486	12
Stephen Houston	Coord, Business Studies	Faculty	589	160
Kauscha Howard	Admin Support Asst II	Classified	1013	207
Kimberly Howard	Admin, Benefits & Retirement	Professional	1070	47
Natasha Howard	Assistant Professor (10)	Faculty	197	203
Patricia Howe	Admin Support Asst II	Classified	341	110
Gina N Howell	Sr Admin Asst II	Professional	1233	135
Timothy Howell	Assistant Professor (10)	Faculty	205	145

Name:	Job Title:	Box Title:	PCN	Page #
Jonathan Howie	Counselor, Admissions	Professional	1537	120
Stephen Hubbard	Veh Equipment Mech I	Unit One	773	64
Robert Hudson	Lab Tech III	Classified	373	155
Kandi Hudson	Professor (10)	Faculty	837	232
Curtis Hughes	Admin Support Asst III	Classified	434	3
Diane Hunter	Clinical Coord, OTA	Faculty	211	230
Irby Hunter	Prog Dir, HIIT	Faculty	594	137
William Hunter	Custodian I	Unit One	782	68
Barbara Hutchins	Admin Support Asst II	Classified	698	187
Melissa Hylock	Accountant I	Classified	1271	191
Andre Ifill	Instructor (10)	Faculty	178	243
Elizabeth Irtenkauf	Coord, Collection Dev	Faculty	91	214
Antoine Isaac	Certified Corporal	Classified	1523	43
Su Isakson	Instructor (10)	Faculty	237	203
Mumtaj Ismail	Coord, Digital Media	Faculty	139	203
Thaddeus Isner	Bldg & Maint Tech I	Unit One	10	58
Terrell Jackson	Lead Custodian I	Unit One	1259	70
Jewel Jackson	Assistant Professor (10)	Faculty	254	205
PJ Jackson	Sr Programmer/Analyst	Professional	743	13
Karen Jackson	Admin Support Asst II	Classified	985	86
Cathy Jamaris-Stauts	Associate Professor (12)	Faculty	186	226
Danielle James	Assistant Professor (10)	Faculty	962	245
Tiffany Javier	Specialist II, Scheduling	Classified	707	127
Scott Jeffrey	Coord, Geospatial Prog	Faculty	167	139
David Jeffrey	Professor (10)	Faculty	252	155
Dominique Jenkins	Analyst, Accts Payable	Classified	1044	29
Helena Jenkins	Instructor (12)	Faculty	1564	229
Kim Jensen	Professor (10)	Faculty	918	205
Edwin Johannes	Bldg & Maint Tech I	Unit One	541	60
Susan Johns	Admin Support Asst II	Classified	1305	186
Wanda Johnson	Admin Support Asst III	Classified	1466	192
Aleita Johnson	Admin Support Asst II	Classified	700	161
Denise Johnson	Admin Support Asst II	Classified	987	188
David Jolbitado	Veh Equipment Mech I	Unit One	549	64
Sandra Jones	Assistant Professor (10)	Faculty	113	202
Michelle Jones	Coord, Criminal Justice	Faculty	135	158

Name:	Job Title:	Box Title:	PCN	Page #
Gwendolyn Jones	Sr Academic Advisor	Professional	1541	109
Karen Jones	Specialist III, Enrollment Ser	Classified	378	132
Theresa Jones	Admin Support Asst II	Classified	50011	98
Tanya Jones	Campus Dir	Administrative	565	21
Joseph Jordan	Supervisor, General Ser	Classified	647	55
Carol Joseph	Professor (10)	Faculty	134	205
Katelyn Joy	Athletic Operations Asst	Classified	759	76
Peter Joyce	Associate Professor (10)	Faculty	1250	145
Jennifer Joyner	Coord, Economics	Faculty	611	245
Steven Jurch	Dir, Health & Human Ser	Administrative	1139	199
Stephen Kabrhel	Dept Chair, Physical Science	Faculty	253	150
Colan Kahl	Project Mgr, Support Ctr	Administrative	1330	5
Patricia Kahl	Admin Support Asst II	Classified	688	156
Alpha KaiKai	Coord, Economics	Faculty	164	245
Gary Kaiser	Professor (10)	Faculty	250	155
Cheryl Kantorski	Admin Support Asst III	Classified	298	212
David Karle	Supervisor, Maint	Classified	38	58
Leo Karpoff	Instr Media Dev	Classified	1076	17
Michele Karr	Academic Advisor	Professional	1490	110
Lee Katon	Dir, Project SPARK	Professional	50013	98
Jadi Keambiroiro	Assistant Professor (10)	Faculty	774	205
Bonnie Kehler	Specialist II, Enrollment Ser	Classified	632	129
Melissa Keim	Specialist, Testing Ctr	Classified	1090	106
Ibele Keinkede	Shift Leader, Dispatch Ctr	Classified	40	43
Joseph Kelch	Mgr, Applications Dev	Administrative	1327	13
Patrick Kelleher	Dir, Planning	Professional	110	48
Rahsaan Kelley	Dir, Call Ctr & Info Ser	Administrative	289	114
Anke Kelly	Sr Accountant	Professional	1376	26
Kelley Kelly	Dir, Upward Bound	Professional	50046	101
Douglas Kendzierski	Dept Chair, Applied Tech	Faculty	533	140
Joyce Kenney	Specialist II, Operations	Classified	1217	170
Sharon Kephart	Custodian I	Unit One	34	67
Stephen Kerler	Certified PSO	Classified	1524	42
Timothy Kerr	Instructor (10)	Faculty	189	152
Nasim Keshavarz	Asst Dir, Financial Aid	Administrative	1173	126
Pamela Kessler	Coord, Criminal Justice	Faculty	1292	158

Name:	Job Title:	Box Title:	PCN	Page #
Jesse Kiefner	Assistant Professor (10)	Faculty	599	147
Daniel Kifle	Associate Professor (10)	Faculty	170	155
Jennifer Kilbourne	Coord, Biology	Faculty	833	156
Harriet Kimani	Coord, Adult Literacy Prog	Professional	78035	181
Laura Kimball	Coord, Interior Design	Faculty	582	138
Margaret Kimble	Custodian I	Unit One	1551	69
Veronica King	Dir, Payroll	Administrative	496	33
Aimee King	Instr Specialist II	Professional	78045	199
Carr Kizzier	Associate Professor (10)	Faculty	950	205
Stacie Klima	Assistant Professor (10)	Faculty	1560	237
Craig Klimczak	Chief Information Officer	Administrative	447	3
Colleen Kline	Instructor (10)	Faculty	115	244
Ann Klingensmith	Admin, HRIS & Classification	Professional	358	45
Abdelkebir Kmir	Assistant Professor (10)	Faculty	158	141
Gail Knapp	Sr Dir, Finance	Administrative	1181	32
Jackie Knight	Asst Dir, Enrollment Ser Ctr	Administrative	1187	134
Michele Knoerlein	Dir, Hunt Valley Ctr	Administrative	1140	169
Suzanne Knutson	Admin Support Asst III	Classified	381	157
Caroline Ko	Admin Support Asst II	Classified	50063	185
Robert Koca	Associate Professor (10)	Faculty	947	145
Shaun Koenig	Assistant Professor (10)	Faculty	1249	162
Allart Kok	Instructor (10)	Faculty	80056	154
Chris Komsa	Associate Professor (10)	Faculty	1396	140
Diane Koubek	Analyst III, Help Desk	Classified	1089	10
Jamileh Kouhestani	Library Tech II, Tech Ser	Classified	1120	216
Shirley Kozlakowski	Admin Support Asst II	Classified	1397	238
Robert Kraft	Asst VP, Admin Ser	Administrative	740	22
Kim Kram	Accountant II	Classified	701	28
Gerry Kramer	Sr Dir, Capital Projects	Administrative	1184	65
Stephanie Kratzen	Assistant Professor (10)	Faculty	613	226
Daniel Krausz	Instructor (10)	Faculty	623	243
Sandy Kreller	Specialist II, Enrollment Ser	Classified	1039	129
Madeline Kuehne	Sr Programmer/Analyst	Professional	1180	13
Robert Kuhar	Instructor (10)	Faculty	898	148
Nancy Kukay	Coord, Tech Training	Professional	1352	194
Renuka Kumar	Professor (10)	Faculty	836	141

Name:	Job Title:	Box Title:	PCN	Page #
Judi Kummell	Admin Support Asst II	Classified	290	172
Fredrick Kumolalo	Assistant Professor (10)	Faculty	180	245
Sandra Kurtinitis	President	Executive	810	1
Marilyn Kuzsma	Associate Professor (10)	Faculty	584	244
Trisha Kyner	Assistant Professor (10)	Faculty	112	138
Steven LaFon	Tech I, Telephone Systems	Classified	332	14
Jennifer Laing	Assistant Professor (10)	Faculty	957	154
Suzanne Lal	Dir, Database Admin	Administrative	520	12
Deborah Lam	Coord, Advanced Modality	Faculty	1561	236
Darnell Lambert	Mgr, Building Ser	Professional	629	70
Donna Lambie	Admin Support Asst II	Classified	1269	190
Theresa LaMotte	Coord, Health Fitness	Faculty	261	243
Amanda Landon	Specialist III, Eval/Trans Ser	Classified	1212	128
Susan Landry	Prog Dir, Mental Health	Faculty	847	225
Melissa Lane	Associate Professor (10)	Faculty	1487	158
Mark Lane	Lab Tech III	Classified	727	138
Matthew Lang	Dean, Con Ed Admin	Administrative	741	164
Wenceslao Lansang	Utility Engineer I	Unit One	1015	62
Lindsay Lassen	Instructor (10)	Faculty	1278	202
Joyce Lathrop-Davis	Associate Professor (10)	Faculty	84	152
Alberta Latorre	Lead Lab Tech	Classified	1046	148
Nancy Laubach	Admin Support Asst II	Classified	1474	199
Johanna Lawrence	Admin Support Asst II	Classified	1134	208
Bruce Laws	Admin, Career Search	Professional	78038	177
Bernard Lawson	Custodian I	Unit One	552	71
Rachele Lawton	Dept Chair, Academic Literacy	Faculty	232	202
Amelia Lazarus	Coord, Legal Studies	Faculty	1516	162
Donna Leach	Specialist II, Scheduling	Classified	1022	127
Erica Leak	Recruiter, Admissions	Professional	51	118
Luba Lebed	Sr Academic Advisor	Professional	329	109
Brittany Lee	Asst Dir, Grants & Schlr Prog	Administrative	460	124
Anne Lefter	Dir, Performing Arts	Administrative	1430	208
Tabitha Legambi	Instructor (10)	Faculty	187	226
Barbara Leitherer	Professor (10)	Faculty	954	148
Laura LeMire	Dept Chair, Engineering	Faculty	228	139
Kelly Lemons	Assistant Professor (10)	Faculty	133	160

Organizational Chart FY 2017

Date: 10/25/2016

Name:	Job Title:	Box Title:	PCN	Page #
Ron Lesko	Supervisor, Maint	Classified	628	60
Keith Lessner	Coord, Police Academy	Faculty	268	158
Sara Leu	Assistant Professor (10)	Faculty	932	160
Albert Lewandowski	Press Operator	Classified	387	91
Arthur Lewis II	Project Coord, Networks	Professional	488	14
Julie Lewis	Coord, Theatre	Faculty	132	204
Garry Lewis	Certified Sergeant	Classified	1526	42
Josephine Lewis	Associate Professor (10)	Faculty	233	244
Daniel Lewis	Assistant Professor (10)	Faculty	924	204
Bill Libman	Sr Programmer/Analyst	Professional	416	13
Armanda Ligabue	Admin, Career Search	Professional	78023	176
Sakina Ligon	Asst Dir, St Life	Administrative	1158	86
Kathryn Lilley	Asst Dir, Academic Advisement	Administrative	1142	110
Richard Lilley	VP Enrollment & Student Ser	Executive	1190	74
Derrick Little	Asst Dir, Financial Aid	Administrative	100	123
Aldo Locco	Analyst I, Help Desk	Classified	1216	9
Claire Loeblein	Admin Support Asst II	Classified	1085	199
Annette Logan	Admin Support Asst II	Classified	284	111
Judi Lohn	Admin, Benefits	Professional	1228	47
Soumaya Long	Coord, World Languages	Faculty	195	202
Kyle Lott	Certified PSO	Classified	1548	41
Eric Lott	Supervisor, Grounds & Fleet	Classified	21	64
Jacquelyn Lucy	Coord, Media Relations	Professional	1343	95
David Ludwikoski	Associate Professor (10)	Faculty	602	152
Jennifer Luers	Specialist I, Enrollment Ser	Classified	406	134
Luke Lukas	Lab Tech II	Classified	1415	153
Eric Lundy	Supervisor, Building Ser	Classified	1413	73
Sonya Luthe	Sr Network Engineer	Professional	1167	14
Melita Lykiardopoulou	Coord, Con Ed IT	Professional	1204	171
Vell Lyles	Analyst, Research & Planning	Professional	352	48
John Lyons	Admin, IT Training	Professional	388	140
Lynn MacLaughlin	Registrar	Administrative	563	127
Ann MacLellan	Coord, Sociology/Anthropology	Faculty	1238	245
Victor Madike	Coord, Physical Science	Faculty	114	151
Susan Maggio	Assistant Professor (10)	Faculty	1511	141
Theresa Magras	Specialist II, Enrollment Ser	Classified	1265	168

Name:	Job Title:	Box Title:	PCN	Page #
Joe Maguire Jr	Library Tech II, Tech Ser	Classified	724	216
Richard Maher	Specialist II, Bookstore	Classified	306	24
Estelle Mahoney	Specialist, Duplicating	Classified	982	91
Donna Mandl	Dept Chair, Legal Studies	Faculty	616	162
Elsbeth Mantler	Instructor (10)	Faculty	840	205
Mary Lou Marks	Specialist I, Advisement	Classified	1119	109
Jennifer Marlatt	Mgr, Nursing Lab	Faculty	143	226
Brenda Marshall	Coord, Con Ed Promotions	Professional	1307	171
Lynne Mason	Coord, Office Tech	Faculty	66	137
George Mateja	Associate Professor (10)	Faculty	217	156
Amy Matschulat	Admin Support Asst II	Classified	679	79
Jane Mattes	Professor (10)	Faculty	97	245
Irene Matusz	Lab Tech III	Classified	1003	150
David Maylish	Assistant Professor (10)	Faculty	846	159
Ben Mayock	Associate Professor (10)	Faculty	166	142
Roksana Mazdeyasni	Specialist I, Accts Rec	Classified	1026	38
Mary Jo McCabe	Dir, Purchasing	Administrative	1153	31
Ted McCadden	Coord, Chemical Dependency	Faculty	596	244
Jean McCalla	Custodian I	Unit One	778	73
Michelle McCallum	Dir, Community Education	Administrative	1274	187
Margy McCampbell	Professor (10)	Faculty	579	205
Sheila McCartney	Specialist, Mgt Info Systems	Professional	50003	183
Marcia McCaskill	Admin, Emp Relations & Equity	Professional	1310	46
Steven McClelland	Custodian I	Unit One	772	73
James McCloud	Bldg & Maint Tech I	Unit One	798	62
Phil McClusky	Tech, TV (Production)	Classified	319	17
Mark McCulloch	VP Instruction	Executive	1226	135
Peggy McCoy	Assistant Professor (10)	Faculty	123	203
Cynthia McDaniel	Child Care Teacher II	Classified	342	83
Brian McDonald	Specialist II, Enrollment Ser	Classified	1007	134
Barbara McDonald	Asst Dir, Facility Operations	Administrative	1183	63
Tricia McDonald	Research Asst	Classified	377	48
Joseph McDonnell	Sr Classroom Engineer	Professional	1282	19
Carol McDonnell	Coord, Instr Support	Professional	50070	183
Sharon McGee	Specialist II, Operations	Classified	333	166
Kevin McGhee	Custodian I	Unit One	1241	69

Name:	Job Title:	Box Title:	PCN	Page #
Myllinda McGinley	Specialist I, St Accts	Classified	659	37
Shirley McKenna	Specialist II, Accts Rec	Classified	326	37
Marty McKenzie	Supervisor, Building Ser	Classified	272	68
Tyrone McKoy	Associate Professor (10)	Faculty	201	145
Maureen McLaughlin	Library Tech III, Public Ser	Classified	335	213
Devon McLaughlin	Admin Support Asst II	Classified	350	172
Jack McLaughlin	Dean of Instr, STAD	Administrative	61	136
Anne McLaughlin	Coord, Teacher Education	Faculty	883	159
Arnold McLemore	Specialist II, Enrollment Ser	Classified	362	168
Elizabeth McManus	Specialist III, Enrollment Ser	Classified	1052	133
Douglas McNamara	Coord, Arts	Faculty	1230	138
Cheryl McNamara	Campus Dir, Practical Nursing	Faculty	154	229
Shawn McNamara	Dean of Instr, SOHP	Administrative	829	225
Christopher McNeill	Bldg & Maint Tech I	Unit One	555	60
Christopher McRoberts	Grants Compliance Officer	Professional	1408	250
Jacqueline McTear	Designer, Creative Ser	Classified	441	92
John McWilliams	Analyst I, Help Desk	Classified	305	8
Lori Meehan	Admin, St Conduct	Professional	1311	80
Shannon Meers	Assistant Professor (10)	Faculty	580	202
Patricia Meidenbauer	Assistant Professor (10)	Faculty	1369	226
Patricia Meiller	Admin Support Asst II	Classified	370	243
Doug Meise	Lead Lab Tech	Classified	1118	151
Richard Mejia	Certified PSO	Classified	279	41
A dugna Mekonnen	Associate Professor (10)	Faculty	614	145
Maria Membrebe	Assistant Professor (10)	Faculty	951	232
Damasia Mena	Certified PSO	Classified	981	43
Charles Mens	Utility Engineer I	Unit One	545	60
Marcia Merriman	Coord, ESOL	Professional	50004	185
Oswaldo Mesa	Assistant Professor (10)	Faculty	121	138
Bonita Metheny	Admin Support Asst III	Classified	892	148
Coleman Mettee	Specialist, Simulation Tech	Classified	29	226
Nancy Meyer	Admin Support Asst III	Classified	401	20
Kevin Mick	Associate Professor (10)	Faculty	603	245
Christopher Mihavetz	Dir, Marketing Comm	Administrative	1179	93
Patricia Miller	Specialist, Accts Payable	Classified	1032	29
Cherie Miller	Admin Support Asst III	Classified	1111	164

Organizational Chart FY 2017

Date: 10/25/2016

Name:	Job Title:	Box Title:	PCN	Page #
Charles Miller	Mgr, Help Desk	Administrative	1381	6
Erik Miller	Professor (10)	Faculty	152	138
Deborah Miller	Instructor (10)	Faculty	160	232
Jennifer Miller	Specialist I, Enrollment Ser	Classified	282	134
Robert Miller	Specialist, Testing Ctr	Classified	379	105
Stacie Miller	Coord, ESOL	Faculty	458	202
Melissa Miller	Asst Dir, College Athletics	Administrative	483	77
Sarah Miller	Recruiter, Admissions	Professional	824	120
Sarah Miller	Coord, Mathematics	Faculty	874	146
Robert Miller	Associate Professor (10)	Faculty	934	205
Penny Milsom	Exec Dir, Human Resources	Administrative	1159	44
Gustavo Minaya	Counselor, Admissions	Professional	480	118
Rose Mince	Dean, Curriculum/Assessment	Administrative	591	209
Robin Minor	Assistant Professor (10)	Faculty	1297	156
Rebecca Minor	Coord, Interpreter Prep	Faculty	459	203
Christine Mirbaha	Professor (10)	Faculty	593	147
Donna Mister	General Ser Specialist	Unit One	12	55
Pamela Mitchell	Specialist II, Call Ctr	Classified	331	114
Ikeem Mitchell	Custodian I	Unit One	80050	68
Rupa Mitra	Assistant Professor (10)	Faculty	1289	148
Megan Molitoris	Academic Advisor	Professional	648	110
Jeremy Monn	Instructor (10)	Faculty	936	150
Suzi Monti	Coord, Instr Support	Professional	50103	183
Phillip Mooney	Associate Professor (10)	Faculty	226	243
Barbara Moore	Admin Support Asst II	Classified	1082	178
Bill Moore	Utility Engineer I	Unit One	6	58
Tammie Moore	Specialist II, Call Ctr	Classified	678	114
David Mora	Certified PSO	Classified	1546	41
Sarah Morales	Coord, Philosophy	Faculty	850	204
Jennifer Morgan	Specialist I, Financial Aid	Classified	432	123
Freida Morgan	Academic Advisor	Professional	78036	176
Edward Morman	Coord, Grants Dev	Professional	744	250
Colin Morrison	Specialist I, Enrollment Ser	Classified	702	133
Judith Moton	Academic Advisor	Professional	58	110
Jan Moure	Professor (10)	Faculty	867	154
Stephanie Mowles	Coord, History	Faculty	172	245

Name:	Job Title:	Box Title:	PCN	Page #
Jacqueline Moye	Admin Support Asst I	Classified	1298	109
Cynthia Moylan	Capital Project Mgr	Professional	1256	65
Susan Moylan	Dept Chair, HIIT/Office Admin	Faculty	56	137
Robert Muller	Instructor (12)	Faculty	1563	234
Sandra Mulryan	Coord, World Languages	Faculty	259	202
Nadette Munongo	Assistant Professor (10)	Faculty	964	145
Francis Murray	Specialist III, Financial Aid	Classified	293	122
Nancy Murray	Assistant Professor (10)	Faculty	80054	202
Ahsan Mushtaq	Analyst I, Help Desk	Classified	1121	8
Sandy Myers	Asst Dir, St Finance	Administrative	631	37
Scott Myers	Academic Advisor	Professional	673	108
Melody Myers	Admin Support Asst II	Classified	696	63
Melanie Myers	Web Content Mgr	Professional	818	94
Erin Myers	Prog Dir, Radiography	Faculty	904	236
Ohnmar Myo	Admin Support Asst II	Classified	78021	175
Ron Nabors	Database Analyst	Professional	517	12
Shila Narain	Assistant Professor (10)	Faculty	944	148
Peter Naron	Coord, Business & Mgt Training	Professional	1165	197
Lloyd Nash	Tech, Telephone Systems	Classified	1384	14
Jodi Neal	Dir, Creative Ser	Administrative	983	90
Arreal Nelson	Admin Support Asst II	Classified	1268	187
Donna Nelson	Accountant II	Classified	637	28
Etroy Nelson	Academic Advisor	Professional	93	110
Latoya Newkirk	Specialist II, Enrollment Ser	Classified	1347	168
Sandy Newstead	Admin Support Asst II	Classified	1094	15
Craig Newton	Coord, Health & Physical Ed	Faculty	1533	243
William Niebauer	Professor (10)	Faculty	1334	138
Vinitha Nithianandam	Associate Professor (12)	Faculty	50114	142
Nelda Nix-McCray	Coord, Sociology/Anthropology	Faculty	1286	245
Patricia Nolan	Associate Professor (12)	Faculty	902	237
Elizabeth Noratel	Assistant Professor (10)	Faculty	257	154
Georgia Nunnally	Technical Trainer	Classified	402	137
Maria Oberle	Admin Support Asst II	Classified	1113	65
Rebecca Ocampo	Coord, Music	Faculty	453	204
Norma O'Connell	Admin Support Asst III	Classified	372	115
Jeannie O'Connor	Sr Admin Asst II	Professional	1019	74

Name:	Job Title:	Box Title:	PCN	Page #
Kim O'Connor-Miller	Asst Dir, Enrollment Ser Ctr	Administrative	639	133
Chris O'Kane	Sr Dir, Applications Dev	Administrative	528	11
Stephanie Olejnik	Library Tech II, Tech Ser	Classified	1079	218
Bryan Olender	Supervisor, Maint	Classified	390	62
David O'Neill	Asst Dean, Science	Administrative	576	149
Robert Oppitz	Groundskeeper	Unit One	554	64
William Osborne	Assistant Professor (10)	Faculty	839	160
Sara Osman	Instructor (10)	Faculty	1290	202
Monica Otal	Coord, Music	Faculty	960	204
Jean Overstreet	Specialist I, Payroll	Classified	1361	171
George Owens	Lab Tech III	Classified	1092	150
Stephen Page	Assistant Professor (10)	Faculty	1194	154
Linda Panella	Dir, IT Support Ctr	Administrative	505	4
Fernando Paniagua	Associate Professor (10)	Faculty	127	141
Donna Pappas	Child Care Teacher II	Classified	664	85
Karen Paris	Dir, Con Ed Mktg & Fac Support	Administrative	1476	171
Carla Parish Ward	Coord, St Success Ctr	Professional	1136	224
Denise Parker	Instructor (10)	Faculty	116	202
Nancy Parker	Assistant Professor (10)	Faculty	125	202
Teresa Parker	Admin, Career Search	Professional	78028	176
Keesha Parks	Specialist I, St Accts	Classified	414	36
Sheryl Parks	Associate Professor (10)	Faculty	864	160
Carole Parlett	Admin Support Asst II	Classified	999	199
Thomas Parlon	Coord, Dance	Faculty	857	204
Pam Passarello	Sr Admin Asst I	Professional	353	136
Shelby Patek	Custodian I	Unit One	31	68
George Pattee II	Assistant Professor (12)	Faculty	1362	140
Suzanne Patterson	Admin, Employment	Professional	1151	45
Dwane Patterson	Groundskeeper	Unit One	792	51
Jennifer Pawlak	Specialist III, Financial Aid	Classified	395	123
Karl Peck Sr	Specialist, Duplicating	Classified	292	91
Jennifer Pemberton	Coord, Psychology	Faculty	225	244
Brian Penn	Coord, HVAC	Faculty	57	140
Angelia Perkins	Specialist II, Call Ctr	Classified	339	114
Robert Perkins	General Ser Clerk	Unit One	974	52
Ricky Perry	Assistant Professor (10)	Faculty	262	203

Organizational Chart FY 2017

Date: 10/25/2016

Name:	Job Title:	Box Title:	PCN	Page #
Dularie Persaud	Specialist I, Advisement	Classified	1021	110
Nelawattie Persaud	Specialist II, Enrollment Ser	Classified	1306	170
Jo Ann Perticone	Admin Support Asst III	Classified	669	171
Shaundel Peters-Gordon	Specialist I, St Accts	Classified	403	36
Shannon Pettijohn	Coord, Admin Scheduling	Professional	507	167
Nellie Pharr-Maletta	Asst Dir, Intl St Ser	Administrative	71	116
Brenda Pieszala	Instructor (10)	Faculty	583	243
Yvonne Pigatt	Assistant Professor (10)	Faculty	53	141
Nancy Pittinger	Admin Support Asst II	Classified	307	198
Emily Plasterer	Lab Tech III	Classified	357	155
Jay Polaki	Dir, Comp & Recruitment	Administrative	1131	45
Michael Poole	Custodian I	Unit One	542	70
Open Position	Custodian I	Unit One	1	68
Open Position	Specialist, Instr Tech	Classified	1005	19
Open Position	Specialist I, St Accts	Classified	1016	38
Open Position	Admin Support Asst III	Classified	1018	107
Open Position	Library Tech III, Tech Ser	Classified	1023	219
Open Position	Admin Support Asst II	Classified	1041	121
Open Position	Asst Dir, Purchasing	Professional	1088	31
Open Position	Specialist II, Operations	Classified	1096	166
Open Position	Custodian I	Unit One	11	73
Open Position	Technical Trainer II	Classified	1101	16
Open Position	Assistant Professor (10)	Faculty	111	145
Open Position	Analyst I, Help Desk	Classified	1110	8
Open Position	Lead Admin Asst	Classified	1112	143
Open Position	Admin, Financial Aid	Professional	1117	124
Open Position	Specialist II, Call Ctr	Classified	1125	114
Open Position	Admin Support Asst II	Classified	1126	247
Open Position	Controller	Administrative	1138	27
Open Position	Dir, Institutional Research	Professional	1141	48
Open Position	Analyst, Research & Planning	Professional	1144	48
Open Position	Dir, Disability Support Ser	Administrative	1146	112
Open Position	Budget Analyst	Professional	1149	34
Open Position	Career Counselor	Professional	1154	102
Open Position	Counselor, Intl St	Professional	1192	116
Open Position	Instr Specialist I	Professional	1203	235

Name:	Job Title:	Box Title:	PCN	Page #
Open Position	Bldg & Maint Tech I	Unit One	1236	58
Open Position	Bldg & Maint Tech I	Unit One	1237	58
Open Position	Clinical Coord Massage Therapy	Faculty	1260	231
Open Position	Dir, Literacy Prog	Administrative	1273	183
Open Position	Sr Programmer/Analyst	Professional	1280	14
Open Position	Sr Instr Designer	Professional	1328	18
Open Position	Specialist, Ent Desktop Config	Classified	1382	5
Open Position	Web Producer	Professional	1383	94
Open Position	Admin Support Asst I	Classified	1394	223
Open Position	Bldg & Maint Tech I	Unit One	1398	60
Open Position	Custodian I	Unit One	1404	69
Open Position	Custodian I	Unit One	1407	68
Open Position	Dir, Multicultural Affairs	Administrative	1410	88
Open Position	Analyst II, Help Desk	Classified	1420	8
Open Position	Specialist II, Enrollment Ser	Classified	1428	130
Open Position	Admin Support Asst II	Classified	1438	112
Open Position	Exec Dir, Facilities Mgt	Administrative	1495	49
Open Position	Prog Dir, PA-C	Faculty	1532	241
Open Position	Coord, Online Learning	Professional	1536	170
Open Position	Academic Advisor	Professional	1538	110
Open Position	Academic Advisor	Professional	1542	109
Open Position	Sr Analyst, Enrollment Mgt	Professional	1543	113
Open Position	Custodian I	Unit One	1550	69
Open Position	Custodian I	Unit One	1554	69
Open Position	Custodian I	Unit One	1557	73
Open Position	Instructor (10)	Faculty	1565	232
Open Position	Assistant Professor (10)	Faculty	161	155
Open Position	Instructor (10)	Faculty	175	205
Open Position	Assistant Professor (10)	Faculty	181	152
Open Position	Supervisor, General Ser	Classified	19	53
Open Position	Admin Support Asst II	Classified	199	1
Open Position	Bldg & Maint Tech I	Unit One	2	62
Open Position	Prog Dir, OTA	Faculty	200	230
Open Position	Bldg & Maint Tech I	Unit One	22	58
Open Position	Mgr, Maint & Utilities	Professional	275	57
Open Position	Capital Project Mgr	Professional	277	65

Name:	Job Title:	Box Title:	PCN	Page #
Open Position	Non-Certified PSO	Classified	280	40
Open Position	Sr Designer	Professional	288	90
Open Position	Bldg & Maint Tech I	Unit One	30	58
Open Position	Specialist I, Enrollment Ser	Classified	311	134
Open Position	Press Operator	Classified	316	91
Open Position	Admin, Emp Relations & Equity	Professional	320	46
Open Position	Lab Tech III	Classified	325	152
Open Position	Tech II, Systems Engineering	Classified	334	14
Open Position	Admin Support Asst II	Classified	336	81
Open Position	Lead Library Tech, Library Tech	Classified	354	221
Open Position	Custodian I	Unit One	36	68
Open Position	Specialist II, Bookstore Accts	Classified	368	24
Open Position	Specialist II, Enrollment Ser	Classified	382	168
Open Position	Coord, Community Education	Professional	43	188
Open Position	Sr Instr Designer	Professional	461	18
Open Position	Admin, Testing Ctr	Professional	49	103
Open Position	Programmer	Professional	499	13
Open Position	Admin Support Asst II	Classified	50034	182
Open Position	Dir, Accounting	Administrative	501	28
Open Position	Analyst, Research & Planning	Professional	508	48
Open Position	Career Counselor	Professional	515	102
Open Position	Dir, Institutional Assessment	Professional	529	48
Open Position	Custodian I	Unit One	537	73
Open Position	Custodian I	Unit One	539	68
Open Position	Custodian I	Classified	543	70
Open Position	Custodian I	Unit One	547	73
Open Position	Assistant Professor (10)	Faculty	571	232
Open Position	Coord, Health & Human Ser	Administrative	59	199
Open Position	Instructor (12)	Faculty	620	229
Open Position	General Ser Tech I	Unit One	630	63
Open Position	Accountant II, Fixed Assets	Classified	636	29
Open Position	Admin Support Asst II	Classified	681	165
Open Position	Dir, Testing & Assessment Ctrs	Administrative	682	103
Open Position	Admin Support Asst III	Classified	683	21
Open Position	Specialist, Athletic Fac	Classified	689	77
Open Position	Library Tech II, Public Ser	Classified	722	217

Name:	Job Title:	Box Title:	PCN	Page #
Open Position	Major Gifts Officer	Administrative	732	247
Open Position	Admin, Emp Relations & Equity	Professional	746	46
Open Position	Dir, Auxiliary Ser	Administrative	754	22
Open Position	Reference/Instr Librarian	Faculty	76	213
Open Position	Admin, Career Search	Professional	78024	177
Open Position	Admin Support Asst II	Classified	78043	176
Open Position	Coord, St Personnel Worker	Professional	78051	181
Open Position	Coord, St Personnel Worker	Professional	78052	181
Open Position	Workforce Developer	Professional	78060	175
Open Position	Workforce Developer	Professional	78061	175
Open Position	Supervisor, Building Ser	Classified	784	71
Open Position	Custodian I	Unit One	786	69
Open Position	Utility Engineer I	Unit One	790	62
Open Position	Custodian I	Unit One	791	68
Open Position	Groundskeeper	Unit One	794	54
Open Position	Groundskeeper	Unit One	799	51
Open Position	Facility Technician	Unit One	8	58
Open Position	Custodian I	Unit One	80049	69
Open Position	Custodian I	Unit One	80053	69
Open Position	Sr Accountant	Professional	80057	30
Open Position	Dir, Inbound/Outbound Comm	Administrative	828	113
Open Position	Assistant Professor (10)	Faculty	849	160
Open Position	Assistant Professor (10)	Faculty	888	150
Open Position	Instructor (10)	Faculty	937	243
Open Position	Dir, Maint & Engineering	Administrative	973	56
Open Position	Supervisor, Building Ser	Classified	977	72
Open Position	Coord, IT Assets	Professional	989	4
Kim Poston	Admin Support Asst II	Classified	638	206
Woodrow Powell	Dir, Community Relations	Administrative	825	246
Michael Powers	Specialist, Ent Desktop Config	Classified	1055	5
Anthony Prabucki	Certified Sergeant	Classified	1520	43
Vanessa Pratinicki	Web Content Mgr	Professional	345	94
Anthony Prescott	Coord, Auto Ford	Faculty	618	140
William Presley Jr	Analyst II, Help Desk	Classified	1024	8
Amanda Price	Case Mgr, SBEJL	Professional	50111	157
Linda Price	Lead Admin Asst	Classified	663	157

Name:	Job Title:	Box Title:	PCN	Page #
Patricia Pritchard	Lab Tech III	Classified	1346	153
Amy Pucino	Assistant Professor (10)	Faculty	612	245
Richard Puller	Asst Dir, Public Safety	Administrative	271	41
Pamela Purvis	Admin Support Asst II	Classified	1002	150
Michelle Pusinsky	Admin Support Asst II	Classified	286	207
Christina Putney	Specialist I, Enrollment Ser	Classified	315	133
Mary Quigg	Assistant Professor (10)	Faculty	418	155
Karen Quinn-Wisniewski	Coord, Electronic Resources	Faculty	1221	219
Patricia Quintero-Hall	Coord, Multicultural Affairs	Professional	1097	88
Elliott Raczkowski	Help Desk Team Lead	Professional	535	8
Marlene Radich	Dir, Academic Advisement	Administrative	827	107
Stephanie Rafferty	Instructor (10)	Faculty	853	150
Debra Ragan	Admin Support Asst II	Classified	723	119
Jignasa Rami	Assistant Professor (10)	Faculty	255	145
Patricia Ramsey	Admin Support Asst II	Classified	424	207
Jason Randolph	Technical Dir	Professional	991	208
Mildred Randolph-Green	Specialist II, Enrollment Ser	Classified	407	168
Barri Rappel	Asst Dir, Enrollment Ser Ctr	Administrative	456	132
Luana Rarey	Assistant Professor (10)	Faculty	845	205
Jo-Ann Rasmussen	Dir, Digital Media Prod Ser	Administrative	462	17
Deborah Raspi-Weldon	Admin Support Asst II	Classified	1370	250
Terri Raulie	Assistant Professor (10)	Faculty	856	204
Michael Redding	Analyst II, Help Desk	Classified	1224	10
Nancy Reed	Sr Admin Asst I	Professional	399	163
Clinton Reed	Custodian I	Unit One	80052	69
John Reed	Coord, Health & Physical Ed	Faculty	925	243
Diane Reeder	Admin Support Asst III	Classified	1034	44
Sina Reid	Dir, St Ser Grant Prog	Administrative	48	97
Russell Rekoski	Help Desk Team Lead	Professional	757	9
Chris Remeikis	Accountant I	Classified	645	37
Karen Renaud	Coord, Wellness	Faculty	241	243
Patricia Rennie	Coord, English	Faculty	890	205
Gayle Restivo	Sr Admin Asst II	Professional	656	1
Patricia Rhea	Associate Professor (10)	Faculty	224	243
Debra Ricci	Specialist I, Enrollment Ser	Classified	1116	133
Lauren Rice	Coord, St Personnel Worker	Professional	78049	181

Organizational Chart FY 2017

Date: 10/25/2016

Name:	Job Title:	Box Title:	PCN	Page #
Bill Rice	Associate Professor (10)	Faculty	931	204
Timothy Richards	Assistant Professor (10)	Faculty	196	141
Denise Richardson	Admin Support Asst III	Classified	1434	211
Candy Richardson	Specialist II, Call Ctr	Classified	652	114
JuJuan Richardson	Admin, Career Search	Professional	78029	176
Robert Richick	Coord, Criminal Justice	Faculty	588	158
Crystal Richmond	Instructor (12)	Faculty	619	234
Steve Ricketts	Coord, Computer Instr Ser	Professional	1185	198
Tenasha Riden	Coord, Intake Assess (ABE/ASE)	Professional	50102	183
Supratman Rikin	Associate Professor (10)	Faculty	247	138
Moire Riley	Coord, Community Education	Professional	1143	189
Laura Riley	Admin, Financial Aid	Professional	750	126
Carolyn Ritenour	Admin Support Asst II	Classified	302	169
Dena Ritter	Lead Library Tech, Public Ser	Classified	291	212
Shervoux Roberts	Child Care Teacher II	Classified	1122	87
Ed Roberts	Coord, Cyber Security Outreach	Professional	50115	142
Cynthia Roberts	Sr Dir, Library Ser	Administrative	561	212
Anne Roberts	Assistant Professor (10)	Faculty	587	205
Laverne Robertson	Coord, Life Enrichment Prog	Professional	1272	190
Thomas Robertson	Associate Professor (10)	Faculty	581	245
Mike Robinson Jr	General Ser Clerk	Unit One	9	55
Theresa Robinson	Coord, Teacher Education	Faculty	585	159
Karen Roettger	Lab Tech III	Classified	1036	154
Niki Rogers	Admin Support Asst II	Classified	1010	238
Anna Rogers	Professor (10)	Faculty	817	205
Daniel Rolandelli	Athletic Specialist	Unit One	376	77
Donna Rongione	Coord, Comm Studies	Faculty	600	203
Keisha Rose	Admin Support Asst II	Classified	340	141
Rae Rosenthal	Professor (10)	Faculty	870	206
Takia Ross	Admin Support Asst II	Classified	1130	157
Donna Rowan	Instr Specialist II	Professional	74001	199
Gretchen Rudham	Assistant Professor (10)	Faculty	894	205
Cleveland Rudisill	Athletic Specialist	Unit One	685	78
Hal Rummel	Dept Chair, ADIM	Faculty	145	138
Andrew Rusnak Jr	Associate Professor (10)	Faculty	162	205
Jean Rusnak	Career Counselor	Professional	82	102

Name:	Job Title:	Box Title:	PCN	Page #
Cindy Ruth	Help Desk Team Lead	Professional	344	7
Robert Rykaczewski	Bldg & Maint Tech I	Unit One	802	58
Ingrid Sabio-McLaughlin	Coord, Women's Studies	Faculty	928	245
Marcia Sachs	Library Tech III, Tech Ser	Classified	355	220
Amir Salehi	Associate Professor (10)	Faculty	1325	204
Teresa Salmon	Admin Support Asst II	Classified	1321	178
Debra Sambuco	Coord, Tech Ser	Faculty	1164	218
Jason Samios-Uy	Admin Support Asst II	Classified	649	207
Arlene Sampson	Custodian I	Unit One	33	69
Michael Sanow	Professor (10)	Faculty	119	245
Kimberly Sansone	Coord, St Personnel Worker	Professional	78053	181
Scott Saunders	Instr Specialist II	Professional	74000	199
Robert Savarese Jr	General Ser Tech I	Unit One	795	52
Denise Savarese	Admin Support Asst III	Classified	1322	209
Barbara Schenk	Prog Dir, Respiratory Care	Faculty	933	237
Gregory Schmidt	Coord, Cyber Security	Faculty	80029	142
Sonja Schmitz	Associate Professor (10)	Faculty	1386	155
William Schockner	Assistant Professor (10)	Faculty	959	152
James Schreiber	Asst Dir, Admissions	Administrative	474	118
Tressa Schuler	Analyst II, Data Support	Classified	384	127
Mike Schumann	Lead Lab Tech, ADIM	Classified	308	138
Megan Schutte	Assistant Professor (10)	Faculty	1421	205
Bennett Schwartz	Analyst I, Help Desk	Classified	408	7
Carol Schwartz	Dir, Veterinary Tech Prog	Faculty	873	235
Jacqueline Scott	Assistant Professor (10)	Faculty	173	205
Caroline Scott	Dean of St Ser, College Life	Administrative	526	75
Cheryl Scott	Associate Professor (10)	Faculty	877	205
Deana Searcy	Sr Programmer/Analyst	Professional	1145	13
Wendy Sears	Library Tech II, Public Ser	Classified	1207	217
Sarah Seibly	Dir, Advising Tech & Training	Administrative	50095	96
Rebecca Seckens	Custodian I	Unit One	766	72
Charles Seltzer	Coord, Psychology	Faculty	875	244
Jeanne Sengebusch	Admin Support Asst II	Classified	360	145
Bill Senter	Analyst III, Help Desk	Classified	443	10
Kathy Serreno	Admin Support Asst II	Classified	281	53
Trevor Setvin	Instructor (10)	Faculty	862	203

Organizational Chart FY 2017

Date: 10/25/2016

Name:	Job Title:	Box Title:	PCN	Page #
Donna Sewell	Professor (12)	Faculty	819	241
Dennis Seymour	Dean of Instr, SBEJL	Administrative	177	157
Patricia Shafer	Dir, Children's Learning Ctr	Professional	756	85
Vernell Shaheed-Levrone	Asst Dir, Public Safety	Administrative	976	43
Nancy Shallenberger	Interim Dir, CLC	Classified	312	86
Hussam Shamoosi	Certified PSO	Classified	980	42
Neeraj Sharma	Associate Professor (10)	Faculty	188	145
Shirley Shaw	Admin Support Asst II	Classified	1093	238
Michael Shaw	Interim Dir, Disability Supp	Professional	1539	112
Shelia Shaw	Custodian I	Unit One	23	68
Jeanne Shawyer	Sr Admin Asst II	Professional	396	2
Regina Shea	Associate Professor (10)	Faculty	866	160
Carol Sherry	Help Desk Team Lead	Professional	1025	10
Katie Shifflett	Admin, Testing Ctr	Professional	1392	106
Frank Shiner	Press Operator	Classified	1109	91
Elizabeth Shrader	Associate Professor (10)	Faculty	1288	150
Christine Shumar	Admin Support Asst I	Classified	1004	224
William Sigmon	Sr Academic Advisor	Professional	522	110
Tenika Silver	Specialist II, Operations	Classified	78057	176
Stephen Simcoe	Admin, LMS	Professional	1232	16
Melissa Simkins	Lead Admin Asst	Classified	997	242
Lois Simmons	Dir, Selective Admissions	Professional	1417	240
Jarrett Simms	Athletic Specialist	Unit One	1073	79
Iona Simms	Admin Support Asst II	Classified	693	78
Alyssa Simms-Clark	Instructor (10)	Faculty	144	202
Marcia Simpson	Specialist I, Enrollment Ser	Classified	448	132
Rebecca Sinclair	Assistant Professor (10)	Faculty	493	232
Kellie Sinibaldi	Instructor (10)	Faculty	159	226
Jen Skarzinski	Coord, Dev Education	Professional	1432	222
Kathleen Sladics	Admin Support Asst II	Classified	1064	245
Kim Slaughter	Instr Aide I	Classified	1038	148
Louise Slezak	Dean, Community Ed & Ser	Administrative	809	174
Andrew Slocum	Press Operator III	Classified	1048	91
Morgan Slusher	Professor (10)	Faculty	881	244
Kent Smedley	Dean, Workforce Dev	Administrative	1437	192
Regina Smith	Coord, Marketing	Professional	1270	93

Name:	Job Title:	Box Title:	PCN	Page #
Nancy Smith	Dir, Grants Dev	Administrative	1294	250
Glenn Smith	Custodian I	Unit One	1403	67
Patricia Smith	Certified Corporal	Classified	1522	41
Ryne Smith	Child Care Teacher I	Classified	374	83
Veronica Smith	Custodian I	Unit One	546	71
David Smith	Mgr, Maint & Utilities	Professional	626	59
Deborah Smith	Sr Admin Asst III	Professional	671	1
Marcus Smith	Technical Dir	Professional	751	208
Tammy Smith	Supervisor, Building Ser	Classified	793	69
Sonya Smith	Instructor (10)	Faculty	855	160
Ileane Smith	Academic Advisor	Faculty	876	109
Ann Smoot	Lead Admin Asst	Classified	660	113
Richard Smothers	Network Engineer	Professional	470	14
Bonnie Snyder	Specialist II, Duplicating	Classified	363	91
Kirk Soistman	Specialist II, Duplicating	Classified	712	91
Robert Solomon	Interim Prog Dir, PA-C	Faculty	808	241
Sylvia Sorkin	Coord, Mathematics	Faculty	942	148
Penny Sorrick	Lead Admin Asst	Classified	1049	75
Esteban Soto III	Dir, Prof Dev Ctr for Excell	Professional	590	161
Izabella Spekterman	Sr Programmer/Analyst	Professional	752	13
Joseph Sperato	Supervisor, Athletic Facilities	Classified	1050	76
Jason Spiegelman	Associate Professor (10)	Faculty	174	244
Gloria Stackhouse	Specialist I, Billing	Classified	386	191
Ann Stearns	Professor (10)	Faculty	965	244
Bonnie Stecker	Managing Editor	Professional	1342	95
Amonti Steele	Analyst I, Help Desk	Classified	1075	10
Karen Stephan	Clinical Coord, MLT Prog	Faculty	1559	239
Gail Stevens	Lead Scheduler	Classified	705	127
Janet Stevenson	Admin Support Asst I	Classified	283	42
Velva Stewart	Custodian I	Unit One	534	73
Jeanette Stewart	Custodian I	Unit One	796	73
Gregory Stiffler	Associate Professor (10)	Faculty	192	148
Raphael Stillings	Instructor (10)	Faculty	165	202
Melissa Stitt	Coord, SBEJL Distance Ed	Faculty	861	160
James Stoecker	Bookstore Mgr	Administrative	1061	25
Cathy Stogel	Sr Academic Advisor	Professional	1423	110

Name:	Job Title:	Box Title:	PCN	Page #
Tracy Stone	Specialist II, Accts Rec	Classified	1341	37
Robert Stone	Dir, Accts Payable	Administrative	654	29
Precious Stone	Associate Professor (10)	Faculty	911	203
Denise Storm	Admin, Class & Comp	Professional	1186	45
Darren Stover	Certified Corporal	Classified	278	41
Celeste Stratton	Dir, LMS & Instr Tech Training	Administrative	80	16
Myron Strong	Assistant Professor (10)	Faculty	264	245
Thomas Stroschein	Dir, Dept Special Projects	Administrative	45	175
Jonathan Struble	Analyst I, Help Desk	Classified	79	8
Roy Stuenes	Mgr, Maint & Utilities	Professional	978	61
Saquan Sturdivant	Groundskeeper	Unit One	37	54
William Sudler	Mgr, Building Ser	Professional	969	72
Dennis Sullivan	Assistant Professor (10)	Faculty	601	160
Jay Summerville	Shift Leader, Dispatch Ctr	Classified	1527	43
Ella Summerville	Admin, Testing Ctr	Professional	300	104
Pete Surgent	Associate Professor (10)	Faculty	1135	148
Linda Sutherland	Admin Support Asst II	Classified	1459	181
Brian Sutt	Systems Engineer	Professional	50105	142
Rick Svoboda	Instructor (12)	Faculty	1562	236
Paige Sweeney	Admin Support Asst II	Classified	337	157
Michael Swidowich	General Ser Clerk	Unit One	17	55
Carla Swingler	Admin Support Asst II	Classified	1000	243
Joan Swiston	Campus Dir	Administrative	564	20
Barbara Swomley	Sr Admin Asst I	Professional	1107	238
Vanessa Sykes	Child Care Teacher I	Classified	1133	87
Daniel Sym	Asst Dir, St Life	Administrative	463	82
Eric Talvik	Specialist, Instr Tech	Classified	1326	19
Michael Tan	Dir, Ctr for ACCESS	Professional	497	179
Hawa Tandia	Academic Advisor	Professional	1063	109
Sidy Tandia	Counselor, Intl St	Professional	1473	117
Joseph Tate	Certified PSO	Classified	655	42
Sandra Tavegia	Assistant Professor (10)	Faculty	251	141
Paul Taylor	Assistant Professor (10)	Faculty	216	159
Dwight Taylor	Supervisor, General Ser	Classified	970	52
Vernell Thames	Assistant Professor (10)	Faculty	156	232
Yvonne Thomas	Specialist II, Enrollment Ser	Classified	1436	168

Organizational Chart FY 2017

Date: 10/25/2016

Name:	Job Title:	Box Title:	PCN	Page #
Andreas Thomas	Custodian I	Unit One	80048	68
Ebony Thomas-Butler	Coord, Selective Admissions	Professional	1418	240
Darryl Thompson Jr	Custodian I	Unit One	1552	71
Darryl Thompson	Custodian I	Unit One	1555	71
Susan Thompson	Assistant Professor (10)	Faculty	265	232
Bradley Thompson	Assistant Professor (10)	Faculty	604	153
Ben Thompson	Sr Dir, Networks & Infrastruct	Administrative	642	14
Valerie Thompson	Custodian I	Unit One	804	68
Dionne Thorne	Dir, Instr Design/OL Learning	Administrative	1234	18
Ann-Marie Thornton	Dir, Dev/Alumni Relations	Administrative	489	247
JoAnn Timm	Sr Programmer/Analyst	Professional	733	13
Sharon Timpson	Custodian I	Unit One	538	73
Tanika Timpson	Custodian I	Unit One	789	73
Tejan Tingling	Associate Professor (10)	Faculty	908	148
Leslie Tinios	Professor (10)	Faculty	896	243
Janine Tipton	Specialist III, Financial Aid	Classified	410	123
Serita Todd	Admin Support Asst II	Classified	992	179
Courtney Topolski	Sr Academic Advisor	Professional	821	109
Bonnie Torres	Admin Support Asst III	Classified	1077	89
Denise Torsell-Bellamy	Admin Support Asst II	Classified	321	193
Ronald Townes Jr	Custodian I	Unit One	5	67
Jane Trainis	Associate Professor (10)	Faculty	891	226
Laura Trauth	Interim Dept Chair, Soc Sci	Faculty	988	245
Debbie Trevathan	Coord, ESOL	Faculty	256	202
April Tripp	Associate Professor (10)	Faculty	945	243
Sheri Trivane	Assistant Professor (10)	Faculty	446	203
Gloria Troncoso	Assistant Professor (10)	Faculty	906	232
Jeremy Trucker	Associate Professor (10)	Faculty	578	205
Encarni Trueba	Professor (10)	Faculty	886	155
Sharon Trumbull	Coord, Arts	Faculty	148	138
David Truscello	Professor (10)	Faculty	605	205
Chanel Trussell	Interim Controller	Professional	719	30
Danielle Truskowski	Associate Professor (10)	Faculty	905	148
Sherry Tucker	Coord, Comm Studies	Faculty	136	203
Rico Tuggle	Analyst I, Help Desk	Classified	442	7
Steven Tyler	Athletic Specialist	Unit One	1008	77

Name:	Job Title:	Box Title:	PCN	Page #
Winnie Unangst	Specialist I, St Accts	Classified	998	38
Christopher Underwood	Bldg & Maint Tech I	Unit One	767	62
Francisco Valverde	Certified PSO	Classified	1155	43
Katherine Van De Wal	Professor (10)	Faculty	930	154
Michael Venn	Asst Dean, Mathematics	Administrative	240	144
Michele Virgin	Library Tech II, Public Ser	Classified	690	216
Cristina Voisei	Assistant Professor (10)	Faculty	485	145
Melinda Vollmer	Advisor, tSTEM	Professional	50117	149
Gail Wachter	Admin, IT Training	Professional	369	196
Thomas Wade	Asst Dir, Public Safety	Administrative	968	42
Nancy Walker	Assistant Professor (10)	Faculty	141	226
LaKeisha Walker	Admin Support Asst II	Classified	695	238
Monica Walker	Dean, Dev Ed/Special Acad Prog	Administrative	816	211
Mary Walkins	Associate Professor (10)	Faculty	150	147
Michael Walsh III	Dept Chair, Comm Arts	Faculty	484	203
Judy Walsh	Coord, St Support Ser	Professional	50035	182
Terry Walter	Coord, Travel Studies	Professional	1105	174
Kenneth Walters	Custodian I	Unit One	3	68
Jessica Walton	Coord, Arts	Faculty	213	138
Raymond Wang	Instr Librarian	Faculty	98	217
Eric Ward	Assistant Professor (12)	Faculty	50107	142
Roger Wardlaw	Specialist II, Operations	Classified	440	170
Susan Warner	Assistant Professor (10)	Faculty	895	154
Eric Washington	Admin, St Conduct	Professional	1248	80
Joseph Washington	Coord, Engineering Tech	Faculty	1374	139
Ryan Washington	Instructor (12)	Faculty	46	140
Adrienne Washington	Instructor (10)	Faculty	72	245
Gwendolyn Waters	Specialist II, Payroll	Classified	346	33
Peter Waters	Instructor (10)	Faculty	92	140
Edward Watkins	Analyst I, Help Desk	Classified	1257	8
William Watson	Dean of Instr, SOLA	Administrative	572	201
Tisha Weaver	Custodian I	Unit One	779	69
Michael Webster	Admin, Financial Aid	Professional	1171	125
Elizabeth Webster	Campus Dir, Nursing	Faculty	54	226
John Wehner Jr	Analyst II, Help Desk	Classified	1103	10
Michael Wehner	Coord II, Aquatics	Professional	338	243

Name:	Job Title:	Box Title:	PCN	Page #
Linda Weinhouse	Professor (10)	Faculty	844	205
Linda Weldon	Professor (10)	Faculty	884	244
Greg Weller	Coord, Auto Global	Faculty	1442	140
Samantha Weller	Child Care Teacher II	Classified	672	85
Rosa Wells	Custodian I	Unit One	551	70
Donald Wenzel	Bldg & Maint Tech I	Unit One	26	62
Bill Werneke	Coord, CAM	Faculty	834	140
Kenneth Westary	VP Institutional Advancement	Executive	1222	246
Joe Whedbee	Assistant Professor (10)	Faculty	1375	147
Margaret Whipp	Admin Support Asst II	Classified	303	238
Dan Whitaker	Associate Professor (10)	Faculty	109	142
Wendy Whitcomb	Coord, OSH	Faculty	1284	139
Judy White	Admin Support Asst II	Classified	50100	185
John Whitelock III	Associate Professor (10)	Faculty	227	160
Vikki Whitmore	Asst Dir, Admissions	Administrative	1182	119
Rebecca Whittington	Analyst, Bookstore	Classified	389	24
Lee Wible	Dir, Budget & Finance Con Ed	Administrative	1220	191
William Wilkes	Certified PSO	Classified	1521	43
Ronald Williams Jr	Specialist III, Enrollment Ser	Classified	295	134
Laurie Williams	Programmer/Analyst	Professional	1172	13
Jeanine Williams	Associate Professor (10)	Faculty	210	202
Doug Williams	Coord, Aviation	Faculty	214	140
John Williams	Certified PSO	Classified	267	43
Mark Williams	Dir, Career Ser	Administrative	467	102
Guernica Williams	Academic Coord/Counselor	Professional	50014	99
Avery Williams	Assistant Professor (10)	Faculty	687	202
Jackie Williams	Admin Support Asst II	Classified	718	238
Nikeeta Williams	Job Developer	Professional	78014	177
Alexia Williams	Specialist II, Operations	Classified	78059	176
Carrie Wilson	Admin Support Asst II	Classified	1043	238
Irene Wilson	Custodian I	Unit One	1242	73
Amy Wilson	Assistant Professor (10)	Faculty	179	205
Byron Wilson	Analyst II, Payroll	Classified	405	33
Wendy Wilson	Specialist, Testing Ctr	Classified	430	104
Courtney Winans	Specialist II, Enrollment Ser	Classified	1395	130
Paul Wingerd	Dir, Building Ser	Administrative	1485	66

Organizational Chart FY 2017

Date: 10/25/2016

Name:	Job Title:	Box Title:	PCN	Page #
William Wingerd	Asst Dir, Facility Operations	Administrative	755	53
Diane Winter	Lab Tech III	Classified	361	152
Dawn Wisniewski	Budget Analyst	Professional	1065	34
Melissa Witemore	Specialist I, Enrollment Ser	Classified	1114	127
Gregory Witkop	Asst Dir, College Athletics	Administrative	1037	79
Judith Woke	Admin Support Asst III	Classified	330	39
Christopher Wolfe	Professor (10)	Faculty	948	204
Sharon Wollschlager	Specialist I, Accts Rec	Classified	415	37
Karen Wons	Coord, Associates to Bachelors	Faculty	889	225
Ollie Wright	Admin Support Asst II	Classified	1163	194
Michelle Wright	Coord, History	Faculty	608	245
Monica Wyatt	Asst Dir, St Finance	Administrative	1012	38
Entela Xhane	Instructor (10)	Faculty	218	148
Donald Yakel Jr	Utility Engineer I	Unit One	269	58
Barbara Yancy	Dept Chair, IT/CS	Faculty	915	141
Michael Yashinski	Instructor (10)	Faculty	1528	154
Aung Ye	Bldg & Maint Tech I	Unit One	627	58
Amy Young	Assistant Professor (12)	Faculty	1366	229
Richard Youngbar	Certified PSO	Classified	971	42
Nicole Zairi	Coord, Artic, Trans & PLA	Professional	296	200
Mohammed Zairi	Sr Academic Advisor	Professional	472	111
Virginia Zawodny	Dir, Financial Aid	Administrative	524	121
Margaret Zellers	Specialist I, St Accts	Classified	1424	38
Steve Zimmer	Assistant Professor (10)	Faculty	919	148
Nancy Zimmerman	Professor (10)	Faculty	242	160
Wayne Zink	Analyst, Bookstore	Classified	1028	25
David Zobel	Associate Professor (10)	Faculty	597	138
Jay Zumbrun	Coord, Police Academy	Faculty	952	158